

REIMO® VAN-CONCEPT



VAN CONVERSION CATALOGUE 2022



www.reimo.com



reimo_com reimocom ReimoCamping

CONTENTS



CAMPINGBOXES
10-16



CONSTRUCTION MODULES
FOR THE SELF-BUILD
18-29



MERCEDES BENZ
CAMPER VAN
80-87



FORD TRANSIT CUSTOM
CAMPER VAN
94-97

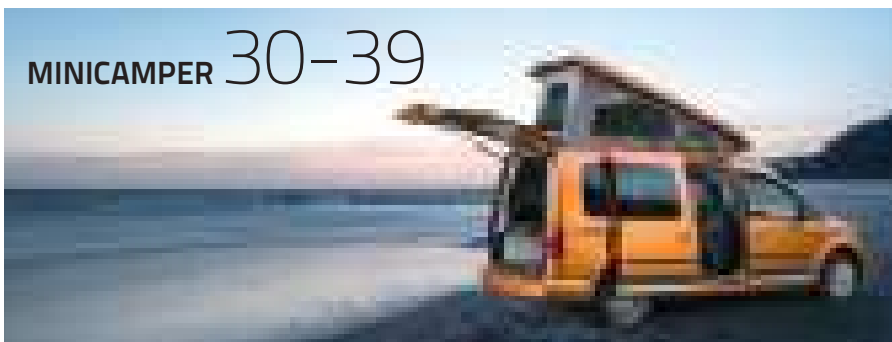

MINICAMPER 30-39



VOLKSWAGEN TRANSPORTER
CAMPER VAN
40-79



RENAULT / OPEL / FIAT / NISSAN
CAMPER VAN 88-93



**SLEEPING/SEATING
BANKSYSTEMS**
146-169

CITROËN SPACETOURER
98-101

SELF BUILD MATERIAL
170-219

MAXICAMPER
104-109

VEHICLE ROOFS
110-145

REMOVAL ACCESSORIES
220-293



Holiday dreams made in Germany!

Competence, experience, innovation & quality for more than 40 years!

Quality through experience & tradition

Over 40 years of experience in camper van and motorhome conversion as well as in motorhome equipment and technology make us a specialist in all questions of conversion and accessories.



And tradition obliges

Against this background we have the claim to build the best motorhomes and leisure vehicles based on panel vans. This claim applies in particular to safety-relevant aspects of our vehicle conversions. The components concerned (e.g. roofs or seat bench systems) are developed and manufactured at Reimo in accordance with current European and national standards.



As early as 1983 we developed the first super-flat sleeping roof in Europe, which could be installed without welding in a frame. Over the years, safety requirements have increased and a wide range of tests have been prescribed for the various interior parts, such as sleeping roofs and benches. After extensive tests, especially with the seat benches by the TÜV Rheinland, we were able to offer the first seat benches for retrofitting.

But also innovations do not come too briefly with us. In our development department, we are constantly designing new extension products. Starting with new sleeping and high roofs, of which we have designed more than 50 models in the last 40 years and have already sold more than 250,000 units worldwide, to the sleeping benches, which offer a particularly high level of comfort, as you can lie on the padded back without the annoying seat belt buckles or the uneven seat surface, to our extension furniture

Especially with the extensions we offer a wide range of choice. From the complete conversion, e.g. the TrioStyle, to the Bike`n`Surf, which is limited to the bare essentials and offers enough space next to the sleeping/seating bench, e.g. for the bike for the weekend trip, to the practical camping box, which contains everything necessary for the holiday and can be installed and removed from your vehicle as required.

Committed to the people.

We produce our conversion parts for our customers. So that they can spend a carefree holiday without having to worry about poor quality or not well thought-out developments

But we also think of our employees, many of whom have been with us for several years.

For this reason, most of our products are produced by us. So we can also offer a constant quality. Made in Germany

Copyright by Reimo Reisemobil-Center GmbH
All prices in € incl. 19 % VAT. Prices are valid until a new catalogue is published.
Delivery subject to change. All products without decoration. Misprints, errors and technical errors and technical changes/developments reserved. All information without guarantee.
The permissible Tolerance for technical data is +/- 5%. Water systems described in the content correspond to the state of the art 10/2007 (Directive 200772/EC). With installation of Equipment ex works (or ex dealer) the unladen mass increases and the payload decreases accordingly the payload is reduced. Some of the illustrations show extras and decorations that are not included in the Included in the scope of delivery or equipment for countries other than Germany. All rights reserved reserved. Reprinting and use in electronic media, also in extracts, only with the express reimo Reisemobil-Center GmbH, Egelsbach, Germany.
Status: 8/2021.



THE REIMO SELF-ASSEMBLY MODULES

For all those who would like to convert their vehicle into a camper themselves we offer camping modules and kits for self-installation.

These products are specially marked with the "SELF INSTALL/SELBST EINBAUEN" logo.

You can choose from camping boxes, kitchen modules, Beds and roofs. Can also be ordered by private customers.



REIMO BENCH SYSTEMS

Sleeper seats that offer extra comfort, sleeping on the padded back, comfortable sitting on 3 seats with belts and retractable headrests.



The sliding Reimo benches meet the highest safety requirements. The sale and installation is only by trained specialist dealers.



REIMO SLEEPING ROOF

Proven safety and high comfort. High legroom due to the large scissors, easy to open, whether manually or electrically. Enjoy the freedom with the 3 windows or the open-sky bellows, which offer a clear view.

The sale and installation is only possible at trained specialist dealers.



THE VW CHASSIS VARIANTS

The right base vehicle for the expansion

Panel van, station wagon, Multivan or Caravelle?

Reimo explains the difference

CHASSIS VARIANT BOX WAGON

This chassis variant is based on the Volkswagen Transporter. The load compartment is now more uncompromising than ever in terms of functionality and versatility

The panel van is delivered from the factory without rear glazing and requires special interior panelling and insulation

The interior fittings (furniture) must be adapted to this special panelling. Camping bus windows can be retrofitted by Reimo according to requirements and furnishing concept.

CHASSIS VARIANT MULTIVAN®

The Multivan® is, similar to the Reimo CityVan and the Reimo Weekender, a multifunctional leisure vehicle - ideal for weekend trips or short holidays.

The standard equipment offers only limited possibilities for conversion to a full camping bus. For longer holiday trips campers with more extensive equipment are more suitable.

At Reimo you can obtain many supplementary elements for retrofitting for more living, sleeping and kitchen comfort for the Multivan®. For example, bed supports, roof storage boxes or mobile kitchen components.

CHASSIS VARIANT COMBI

Reimo has adapted the facilities of most small camping buses to the station wagon chassis variant. As interior trim, the station wagon usually has a simple, non-bulky trim

It therefore offers the most usable interior space. This allows for more bed width and a longer bed length in the Volkswagen Kombimodel (compared to the Caravelle)

The exterior appearance of the Volkswagen Kombi has passenger car appeal. The large window areas provide plenty of light in the vehicle and allow a good all-round view in city traffic .

CHASSIS VARIANT CARAVELLE®

The Caravelle® model from Volkswagen is equipped ex works with a visually appealing interior trim and some additional comfort features. Sophisticated and of high quality.

However, valuable interior width and length is lost due to the lavish interior.

With the roof structure (pop-up or sleeping roof), the special panelling is elaborately adapted. Reimo has developed its own furniture versions such as TrioStyle and CityVan for the Volkswagen Caravelle®

The dimensions of the furniture and roofs are adapted to the Caravelle®. The installation time for the Caravelle® is significantly longer than for the standard chassis variant due to necessary adjustments to the standard panelling .

**For further information
at: www.reimo.com**

The designations for panel van, estate van and luxury bus vary from vehicle manufacturer to vehicle manufacturer. Caravelle and Multivan are registered trademarks of Volkswagen AG.

THE VEHICLE LENGTHS

The right base vehicle for the expansion

Short, long or extremely long wheelbase?

Reimo produces camping bus equipment for vehicles with different wheelbases. Additional modules can be manufactured for many other base vehicles.

SMALL CAMPERS

2 WHEEL STANDS

Many small buses such as the Volkswagen Transporter, Mercedes Vito, Renault Trafic or Opel Vivaro are available in 2 wheelbases.

With these vehicles, **the short wheelbases (KR)** are usually preferred because of the manoeuvrability and the parking situation in large cities. However, the **long wheelbases (LR)** offer approx. 40 cm more interior length (with Volkswagen) and thus also more living space!



LARGE CAMPERS

3 WHEEL STANDS

Many large buses such as Volkswagen Crafter, Mercedes Sprinter, Fiat Ducato or Iveco Daily are available in 3 or more wheelbases. With the large buses, **the middle wheelbase is usually** preferred for the expansion. Upon request and agreement, Reimo can usually supply components for all wheelbases.

The equipment for large camping buses is adapted to the van chassis variant. This chassis variant does not have pre-installed windows. This offers the possibility to install windows only where they are needed.

Sometimes the chassis variant with standard windows in the sliding door and on the opposite side of the vehicle is chosen.



QUALITY CAMPING BUS FURNITURE MADE IN GERMANY

Durable furniture construction and simple assembly

Reimo Originals

The special features of Reimo developments

Furniture boards

Reimo furniture construction boards are characterised by their particularly good suitability for the construction of vehicles. The poplar plywood carrier material is extremely light and torsion-resistant due to the 7-fold gluing. At the same time, it is a natural product and a very economical solution. The very robust surface quality (high impact and scratch resistance) is achieved by coating both sides with high-quality laminate in HPL or CPL quality (HPL = High Pressure Laminate /CPL = Continuous Pressure Laminate). This makes the furniture much more hard-wearing, less sensitive to temperature fluctuations and more durable than, for example, furniture with a film coating.

Another advantage of Reimo furniture boards is the possibility of clean processing with normal, commercially available tools.

Quick-Fit Solid Art®

Reimo furniture has a clever and particularly stable connection technology: the Reimo Quick-Fit Solid Art® system. The clear allocation and positioning of the parts makes assembly almost child's play for laymen and professionals alike. The friction-locked interlocking of the furniture parts reduces noise development and guarantees the well-known durability of Reimo furniture. The furniture body has a very high stability after screwing.

(Quick-Fit Solid Art® is a registered trademark of Reimo Reisemobil-Center GmbH)



Guaranteed quality

Over many years we have learned that the stability, appearance and utility value of a piece of furniture depend on the high-quality materials and precise manufacturing. Reimo has therefore been manufacturing interiors on computer-controlled machining centres since 1988. So that the dimensions are correct and the repeatability is given!

Individual extensions

Reimo has been manufacturing motorhomes for 40 years. For more fun and joy on vacation Reimo wants to meet the wishes and ideas of the customers especially with individual extensions.

Over the years, many individual designs have become standard modules, which give you the security of tried and tested elements.

We therefore recommend - if possible - that you choose an interior that has already been built many times in a series module. Of course, the price is also lower than for an individual custom-made product.



Individual furnishings

The Reimo facilities are intended for installation in an empty vehicle without additional equipment from the manufacturer, such as a heat exchanger or original plastic interior panelling. Our floor plate with a total thickness of approx. 25 mm is taken as the basis for the floor construction. Deviations from this basic equipment may require adaptation work/additional expenditure. The CityVan equipment cannot be used in conjunction with the full panelling with integrated roller blinds.

The equipment is aligned to the vehicle-specific bench seat and to the technical equipment with the defined components and possibly provided with cut-outs for this.

Of course we advise thereby our customers with our experience of many years. Nevertheless, every individual vehicle remains a prototype the first time it is used, which may not be perfect in all details!



ADVANTAGES OF OUR MATERIALS

Know-How and experience for highest travel and holiday comfort

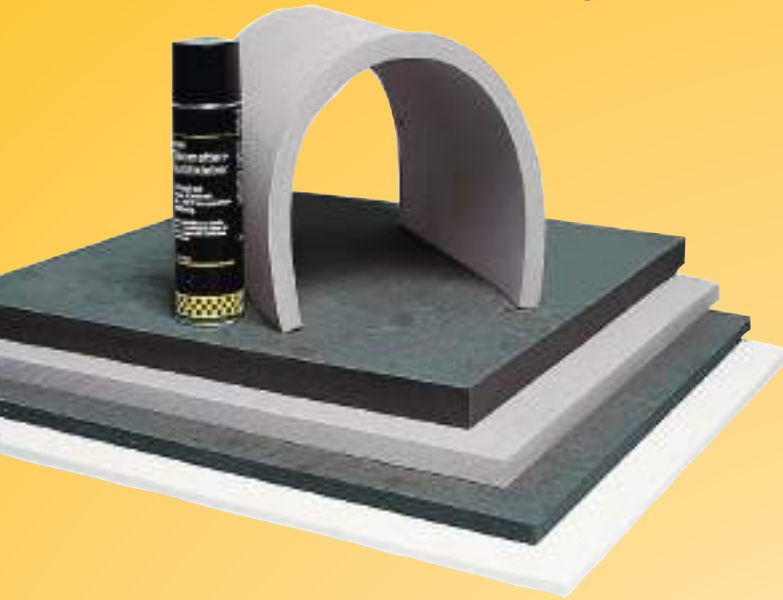

Insulation - with Reimo insulation sets

Reimo complete vehicles are extensively insulated against sound and heat

A considerable reduction in condensation and simultaneous heat insulation is achieved by insulating interior sheet metal surfaces and in some cases cavities with the Reimo product Xtrem-Isolator in various thicknesses.

If desired, the self-adhesive Carbest anti-noise mat can also be applied to the sheet metal surfaces to optimise sound insulation. The insulation set is then attached with Sika adhesive.

Interior trim

For the vehicle interior lining, Reimo uses and offers homely materials that are highly efficient in terms of sound and heat. Hardboard or light plywood panels are covered with laminated Isovellour or felt

These materials can absorb and release moisture. Alternatively, laminated imitation leather is available as a particularly easy-care solution

All these Reimo materials are particularly stretchable, so that they can be optimally moulded to the contours of the car body. To ensure that they adhere well over the long term, we recommend using the highly heat-resistant spray adhesive (Reimo item no. 500130).



Reimo vehicle roofs made of GRP

Reimo roofs are offered in 2 different types:

The low-cost, single-skin roof has a high-gloss exterior or top side and a somewhat rougher underside. From the underside, the largest area (bed and living area) is usually covered with homely Isovellour.

The more modern, double-shell roof (e.g. also V-TEC series) offers top and bottom sides in GRP gelcoat high gloss. This type of construction allows a high-strength, elegant design with an even higher quality finish. The smooth surfaces also make it easier to clean.

Tent bellows fabrics

The Reimo sleeping roofs are equipped with different tent bellows materials: Even the conventional tent bellows shines compared to the classic cotton tent bellows due to its very good breathability and improved care properties, among other things. It offers plenty of light and air through the openable side windows and the front window.

The new Climagic bellows feature a newly developed synthetic material with even better breathability, improved weather resistance and easier maintenance and if you want to enjoy the view and plenty of fresh air, you can opt for the OpenSky version, which simply zips open.



Mosquito nets

The insect protection nets used by Reimo in tent bellows are particularly popular due to their tight mesh and robustness. They are equipped with high-quality zippers.

All this also applies to the mosquito nets offered as accessories for doors, windows and rear flaps.





REIMO VAN-CONCEPT

REIMO CAMPINGBOXES

With the Reimo CampingBox, your commercial vehicle becomes a camper for short holidays or weekend trips in no time. Suitable for mini campers such as Caddy Maxi, Berlingo, Spacetourer or Jumpy. The multifunctional CampingBoxes are also available for VW T6.1/T6/T5 as well as VW Multivan, VW California Beach or Mercedes Benz Vito.

The Reimo CampingBoxes - practical rear kitchen modules with storage space system

- CONTENTS -

CAMPINGBOX VW (FOR MB VITO WEEKENDER).....	12-13
CAMPINGBOX M (FOR MINICAMPER).....	14-15
CAMPINGBOX L (FOR VW T6/T5 AND OTHERS).....	15
CAMPING BOX L-CM (FOR VW T6/T5 CALIFORNIA BEACH + MULTIVAN).....	16
LUGGAGE DRAWERS (LUGGAGE BUTLER).....	17



**SELF
INSTALL**
SELBST EINBAUEN



CAMPINGBOX WV

Suitable for Mercedes Benz Vito with Reimo Weekender seat bench

Ideal travel companion for camping holidays or spontaneous short trips.

- Multifunctional rear kitchen with clever storage system
- Well thought-out, comprehensive basic equipment
- Easy installation without modifications to the vehicle
- Rear wall flap can be used as a storage area or work surface
- High-quality HPL surface, Pearl Black decor
- Open rear flap also provides protection in the rain (can be optimally extended with a rear tent)
- Lateral carrying handles for easy transport as well as installation and removal



Accessories shown are not included in the scope of delivery



Multifunctional, extensively equipped and ready for use anywhere. The CampingBox is the ideal camping module for short holidays, weekend trips and for active leisure fun.



The multifunctional CampingBox WV is placed in the rear of the vehicle and screwed into the floor rails. The rear shelf of the bench seat is removed, the original rear cushion then lies on the camping box and results in a flat lying surface with the bench seat-sleeper.

The height of the camping box WV is suitable for the Reimo Weekender bench seat for Mercedes Vito. For use with a Reimo Weekender bench in the VW, Renault or Ford Transit, a 30 mm thick additional pad is required to achieve a level lying surface.

Scope of delivery:

- Left two drawers with practical folding silicone sink and faucet
- In the middle 2 plastic storage boxes, behind them the water system with 10-liter fresh water canister and submersible pump.
- A right-hand pull-out for the optional 28-litre Carbest compressor cooler

CampingBox WV

Dimensions: approx. W 119.5 x H 43 x D 70/62 cm, decor: Pearl Black

13263

1829,-

Optional accessories:

Carbest 28l-Compressor coolbox
Gas cartridge stove, 1 flame

71375

469,-

706474

54,99

CAMPINGBOX M

Suitable for Minicamper like VW Caddy, Citroën Berlingo, Renault Kangoo II and others.

From everyday vehicle to mini camper.

- Combines functional rear kitchen with a clever storage system
- Easy installation without modifications to the vehicle
- Extensive standard equipment
- Bed module with large lying surface Optional
- Side folding table
- Compactly dismantlable and space-saving to stow away

Suitable for the following vehicles:

- VW Caddy (2003-2019)/Caddy Maxi (2008-2019)
- Citroën Berlingo Multispace (2008-2018)/ Spacetourer/Jumpy (from 2016)
- Peugeot Partner Tepee (2008-2020)/ Traveller/Expert (from 2016)
- Renault Kangoo II (from 2008)
- Mercedes Benz Citan Kombi kR (from 2016)
- Toyota Proace Verso/ Proace (from 2016)
- Nissan NV 200/ NV 200 E/Evalia (from 2009)
- Opel Vivaro C/Zafira Life (as of autumn 2019)

Scope of delivery:

- Left kitchen pull-out is equipped with folding sink, 10-litre fresh water canister with outlet tap, 1-burner gas cooker, cutlery drawer and folding shelf
- Right-hand pull-out for optional 16-litre compressor cooler. This is removable and is supplied by the 12 V on-board power supply
- 2x removable storage boxes
- 1x mobile folding trolley (see picture above)

The necessary cooking utensils also have their place in the kitchen pull-out. This is removable and can be set up separately outside the vehicle on an optional folding trestle.

Dimensions: WxHxD approx. 111x47x74 cm

CampingBox M	13252	1729,-
Bed module for CampingBox M		
incl. upholstery, installation material and installation instructions, sleeping area approx. 195 x 120 cm	13253	1019,-

Optional accessories:

16-litre compressor cooler	71355	469,-
Rear tent Upgrade 2	936280	149,-



Cooking and washing up while standing, without having to bend down. Removable kitchen box with folding sink and 1x 10-litre water canister as well as storage space for cooking utensils.

The optional 16-litre compressor cooler can be pulled out and is powered by the 12 V on-board power supply.

Optional, comfortable and quickly assembled bed. The cushion is attached to the box at the rear using Velcro and rests at the front on the wooden plates supplied, which are attached to the head restraints using straps (VW Caddy KR).

For other vehicles, it is attached to the safety belt fasteners of the B-pillars.

The Reimo CampingBox can be dismantled to save space in the cellar or garage. (Fig. also shows optional accessories such as cool box and Porta Potti).



CAMPINGBOX L

Suitable for VW T6/T5, MB Vito, Fiat Talento etc.

The multifunction box for VW T6/T5, Vito & Co.

- Rear kitchen module with practical storage system
- Easy installation without modifications to the vehicle
- High-quality HPL surface
- Extensive standard equipment. e.g. cooker*, folding sink, storage boxes and water canisters
- CampingBox L can be extended with optional bed module with large lying surface
- Can be compactly dismantled and stored to save space

Suitable for the following vehicles:

- VW T6/T5 Transporter Kombi or Caravelle, short/long wheelbase
- Mercedes Vito long and extra long
- Fiat Talento/Nissan NV 300/Renault Trafic/ Opel Vivaro B, short/long wheelbase (without plastic cladding)

Cooking while standing, without having to bend down. Removable kitchen box with folding sink incl. 2x 10-litre water canisters.

Comfortable, large lying surface on the optional bed module. (Picture shows bed module in VW T6 Caravelle)

The optional 21-litre compressor cooler can be pulled out and removed and is supplied by the 12 V on-board power supply.

Fresh water at all times thanks to the practical 10-litre water canister with outlet tap.

Scope of delivery

- Left kitchen pull-out is equipped with folding sink, two 10-litre fresh water canisters with outlet tap, mobile 1-burner gas cooker, 2 drawers, cutlery compartment and folding shelf
- Right-hand pull-out for an optional cool box, (16-litre or 21-litre compressor cool box possible, powered by the 12 V on-board mains).
- 3x removable storage boxes in the middle
- 1x folding trestle to place the kitchen pull-out outside the vehicle.

Behind the storage boxes is storage space for an optional mobile camping toilet or additional storage boxes 1x high/1x flat (optional).

Dimensions: WxHxD approx. 118x60x80 cm

CampingBox L 13250 1789,-

Bed module for CampingBox L

incl. cushion, sleeping surface 200 x 150 cm

13251 1119,-

Optional accessories:

21-litre compressor cooler

711615 718,-

Porta Potti 335 Cube 660102 144,95

Rear tent Upgrade 2 936280 149,-

Storage box high 94915 7,90



CAMPING BOX L-CM

Suitable for VW T6/T5 Multivan and California Beach

CampingBox with full equipment

- Combines functional rear kitchen with a clever storage system
- Easy installation without modifications to the vehicle
- Extensive standard equipment
- Bed module with large lying surface optional
- Side folding table
- Compactly dismantlable and space-saving to stow away

- The clever addition for the VW T6 / T5 Multivan KR or LR or California Beach, each with original 3-seater bench
- Perfect handling and ideal height with open tailgate

The box is fastened in the luggage compartment to the floor rails or lashing eyes on the vehicle. Lateral carrying handles facilitate handling. No modifications to the vehicle are required for installation.

Scope of delivery:

- Left-hand kitchen pull-out is equipped with a folding sink, 12-litre fresh water canister with outlet tap, 1-burner gas cooker (fits in top drawer), 1x folding shelf, a folding utensil compartment with 4 fresh food boxes, 4 sets of plastic glasses/cups/dishes. 2 drawers including 1x cutlery tray with cutlery, 1x Elite pot set and 1x kettle
- 2x storage boxes in the middle
- Right-hand pull-out for an optional 16-litre compressor cooler (supplied by the 12 V on-board power supply).

Behind the storage boxes is storage space for an optional mobile camping toilet or additional storage boxes 1x high/1x flat (optional). With a sleeping cushion you can supplement the lying surface of the original 3-seater bench in the rear area. Thus the VW-Multiflexboard is not needed for the bed construction. Dimensions: WxHxD approx. 118x47x80 cm.

CampingBox L-CM 13254 2449,-

Optional accessories:

Comfort cushion	13254P	219,-
Compressor cooler 16 l	71355	469,-
Porta Potti 335 Cube	660102	144,95
Storage box high	94915	7,90



Cooking and washing up while standing, without having to bend down. Kitchen pull-out with folding sink and 1x 12-litre water canister as well as storage space for cooking utensils.

Practical folding utensil compartment incl. 4 freshness boxes each, plastic glasses, cups and plates, Cutlery, Elite pot set and kettle.

The optional comfort cushion turns the reclining surface of the original 3-seater bench into a bed. For even more comfortable reclining or if a multiflex board cushion is not available in the Multivan.

The optional 16-litre compressor cooler can be pulled out and removed and is supplied by the 12 V on-board power supply.



THE LUGGAGE BUTLER

Luggage drawer for convenient loading of the luggage compartment

Easy and convenient loading and unloading of your vehicle with the bed in place

- Heavy-duty full extension slides with a load capacity of 130 kg per pair
- Fastening covers all vehicle-specific rail spacings
- Frame is fastened in the floor rails
- Special rear extensions for VW California Coast/Beach/Ocean and Multivan



The rear pull-out makes it easier to load and unload your vehicle when the rear seat has been converted into a bed. The rear extension uses the entire remaining boot space.

The frame of the rear extension is securely connected to the vehicle at four points. Supplied pre-assembled.

Scope of delivery: Includes mounting and fastening materials, belt eyes, pull-out rails, base plate and assembly instructions



Vehicles	Outer dimension Width x length in mm	Footprint Width x length in mm	Art.no.:	Price
VW Avantgarde VW Triostyle with canister	930 x 600	875 x 557	50512	479,-
Mercedes Triostyle Renault Triostyle VW TrioLoft VW Triostyle furniture only	1050 x 600	995 x 557	50513	489,-
Ford Triostyle VW Cityvan VW Weekender Plus	1170 x 600	1115 x 557	50514	509,-
Mercedes Cityvan and Weekender Renault Weekender VW Weekender	1220 x 600	1165 x 557	50515	509,-
California Coast/Ocean as of 2003	995 x 750	940 x 709	50518	579,-
California Beach, Multivan	1075 / 1200 x 750	1020 x 709	50519	619,-



**SELF
INSTALL**

SELBST EINBAUEN

– CONTENTS –

.....

COMFORT BEDS FOR VW, MERCEDES BENZ & CITROËN	20-21
ADDITIONAL BEDS FOR CAB	22-23
KITCHEN MODULES CALICOOK + CALISCHRANK	24-25
FLEX KITCHEN WITH GAS SYSTEM	26
MULTIFUNCTIONAL KITCHEN PART EASY-KITCHEN	27
MULTIFUNCTIONAL KITCHEN MODULES	28-29

.....



REIMO VAN-CONCEPT

FURNITURE MODULES

Here you will find kitchen and cupboard modules for flexible camping and leisure. Expand your van with the Reimo modules and turn it into a comfortable leisure vehicle with the comfort beds or additional beds for the driver's cab.

COMFORT BEDS QUICKLY AND EASILY INSTALLED

For Mercedes-Benz, VW T6 and Citroën



- Aluminium frame with comfortable slatted frame suspension
- Comfortable maxi bed with a lying surface of 195 x 140 cm
- Luxury mattress 12 cm thick, with high-quality Drell cover
- Clearance height under the bed 33.5 cm (suitable e.g. for Porta Potti 335 Cube)
- Foldable for installation of original single seats
- Easy to install and remove without modification to the vehicle





The bed is fixed in the original floor rails with quick clamps.
 Scope of delivery: bed construction with slatted frame and comfort mattress 12 cm thick and fixing material. Dimensions when folded: 150 x 140 cm.



Comfort bed for Citroën SpaceTourer/Vanster
 The bed is mounted in the seat rails of the Spacetourer. The height is adjusted so that one rear seat row can remain in the vehicle.

Comfort bed for Mercedes-Benz: Fits in VS20, length 5.14 m (Vito and V-Class) with the seat rail system. Two individual seats can remain in the vehicle, but must be pushed all the way to the front and placed in transport position when the bed is assembled.

V-Class and Vito **93023** **949,-**

Comfort bed for VW T5/T6: The bed is mounted in the seat rails of the Multivan or California Beach. For Transporter and Caravelle there are corresponding adapters to fix the bed in the lashing eyes. The seats must be removed for this.

Multivan/California Beach **930231** **999,-**
Adapter for Transporter/Caravelle **930232** **89,-**

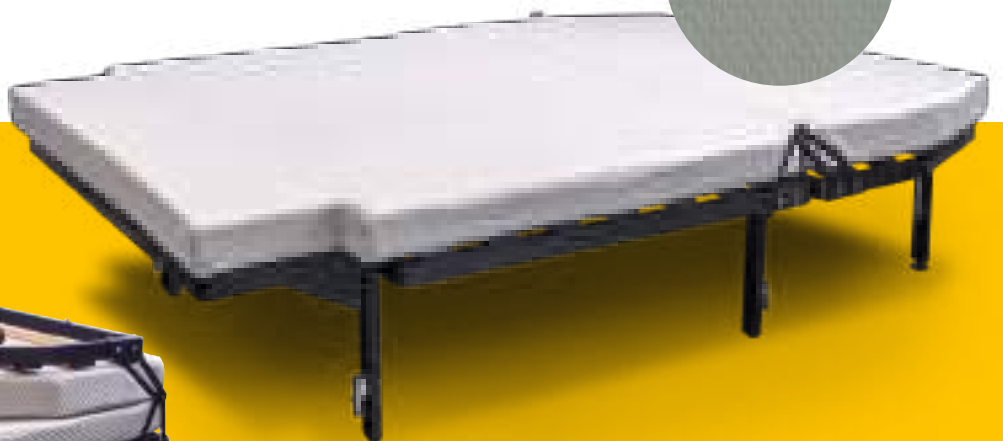
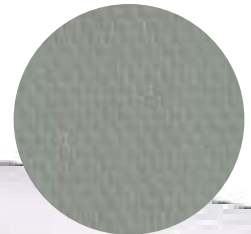

ADDITIONAL BEDS FOR CAB

Patented cab bed system for cab swivel seats

- For additional sleeping space in the driver's cab
- Easy assembly & disassembly in 30 sec.
- Very stable, each bed carries up to 70 kg
- Strong, wipe clean Cordura fabric
- Compact pack size when not in use & for storage
- Each child has its own place to sleep
- Sleeping surface: 174 x 55 cm
- Robust, double-walled telescopic aluminium pole
- Mounting kit for easy attachment to sliding doors or swivel seats
- Weight: single bed 3.5 kg, double bed 7 kg



Fastening by hooking onto the headrests

Mounting on supplied aluminium telescopic rods

Please note: the additional cot is only suitable for vehicles with cab swivel seats!



	VW T4/5/6		VW Transporter (with double seat)		Ford Transit		Renault		Mercedes Sprinter, VW Crafter		For Fiat Ducato, Peugeot Boxer	
Single bed	42178	245,-	42188	245,-	42185	199,-	42181	199,-	42183	199,-	42176	199,-
Double bed	42179	425,-	42189	425,-	42186	379,-	42182	379,-	42184	379,-	42177	379,-
Mounting kit	42180	79,94	42180	79,94	42187	79,94	42187	79,94	42187	79,94	42187	79,94

BED EXTENSION AND UPHOLSTERY MULTIVAN

- With the Lazy Bed, together with the original bench seat, you can "conjure up" a comfortable sleeping area in your Multivan in no time at all

① Extension Lazy Bed

The bed extension is anchored behind the bench seat in the sliding rails. In everyday use it can be used as a boot cover. With metal support feet and 2 quick-release fasteners. Approx. dimensions: Width 1284 x length in driving direction 564 x height 520mm
Decor anthracite metallic. **11101 366,39**



② Comfort cushion for Lazy Bed extension

This comfort cushion turns the "hilly" and hard bed landscape of your Multivan into a level, comfortable bed. The folded comfort cushion fits on the cover plate.
Cushion dimensions: approx. 135 x 190 cm, Cover microfibre fabric (100% polyester) grey, Foam approx. 5 cm thick.
11003 219,-

ADDITIONAL BEDS FOR CAB

CampSleep extra bed for driver's cab

Additional bed for driver's cab in motorhomes such as Ducato, Sprinter

CampSleep is suitable as a comfortable additional bed for the driver's cab in motorhomes (2-seater) from 2005 onwards, e.g. Ducato / Sprinter / Transit / Crafter / Boxer / Master / Jumper / Daily. CampSleep is folded up 2-fold. Total length from door to door is approx. 160 cm. The depth to the glove compartment is approx. 74 cm, to the steering wheel approx. 44 cm. Dimensions: L 160 x W 73 x H 10 cm. Packing size: L 81 x W 73 x H 20 cm. Weight approx. 6,5 kg

① **CampSleep additional bed** 42173 372,-

Optional bag for CampSleep extra bed (not shown)

Protects against dirt and dust.

CampSleep protective bag 421731 27,50

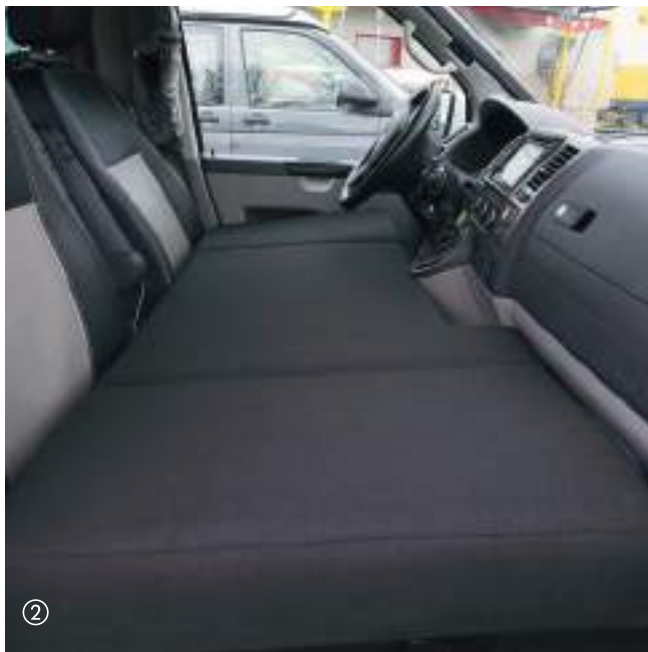
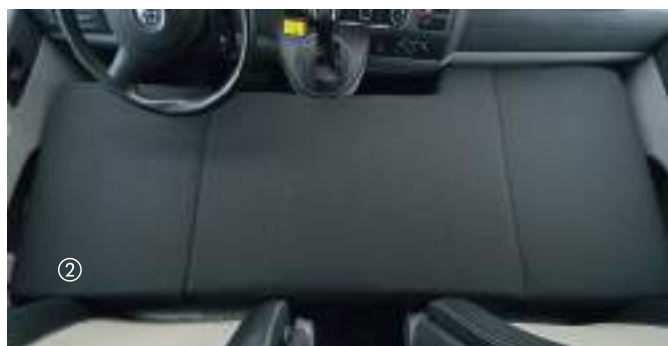

CampSleep small

Additional bed for the driver's cab in small commercial vehicles

CampSleep small, the comfortable additional bed for the driver's cab of vehicles in the smaller commercial vehicle class, e.g. Volkswagen, Mercedes-Benz Vito, etc. The bed is only folded out in 2. Thus, another sleeping possibility can be created comfortably on the seats in the driver's cab.

Dimensions: L 148 x W 64 x H 10 cm. Pack size: L 75 x W 64 x H 20 cm. Weight only approx. 6 kg.

② **CampSleep small additional bed** 42174 246,-

KITCHEN MODULE CALICOOK - VW T6.1/T6/T5

For Volkswagen T6.1/T6/T5 California Beach and Multivan



Equipment Calicook:

- Stainless steel sink with removable folding bowl insert
- Water system with submersible pump and shower tap with hose and 1 fresh and 1 waste water canister each of 10 l
- Heavy-duty pull-out for optional 35-litre Dometic compressor coolbox
- Drawer for crockery and cutlery with pull-out shelf

Dimensions: W 650 x H 785 x D 640 mm
(table height 710 mm, carcase width 410 mm)
Pearl wood finish **11120** **2059,-**

Upgrade your California Beach or Multivan to a real camping bus with Calicook

- Practical kitchen section for installation behind the driver's seat
- Can also remain in the vehicle in the sleeping position of the bench seat
- Optimum space for 2 people to eat at the folding tables
- Sink with water tap
- Plenty of storage space, large drawer with room for a cool box
- The kitchen unit can be left at home for everyday use



Kitchen part for installation transversely behind the driver's seat of the VW T5/T6 California Beach and Multivan with original VW 3-seater bench. Body can be moved in the direction of travel in VW floor rails.

The Calicook offers a stainless steel sink with shower tap and water system with a 10-litre fresh and waste water canister each, a pull-out for a large 35-litre compressor cooler (optional) and storage space.

The practical folding table and pull-out shelf turn the kitchen section into a breakfast table for everyone. The clever splash guard protects the upholstery of the driver's seat. Thanks to the longitudinal adjustability, every driver can sit comfortably and relaxed.

Of course, even with the kitchen section installed, the full bed length is available. In everyday life Calicook can stay at home, it can be removed in no time without tools. Of course, Calicook can also be used outside the vehicle (e.g. in the awning or under the awning).



The longitudinally sliding kitchen leaves enough space for tall drivers to push the driver's seat backwards



Practical: the sink with water tap and rinsing bowl



Integrated fresh and waste water canisters

Decorative material shown is not included.

KITCHEN MODULE CALI CABINET - VW T6.1/T6/T5

For Volkswagen T6.1/T6 /T5 California Beach and Multivan

Plenty of storage space and work surface with the kitchen module CaliCabinet

- **The perfect furnishing module for VW T5/T6 California Beach and Multivan KR and LR***
- **Sliding and removable**
- **Installation without tools and modification to the vehicle**
- **Fits even with bench in sleeping position**
- **Plenty of storage space, large drawer with space for a cool box**
- **The kitchen cupboard can stay at home in everyday use.**

* each with 3-seater VW bench seat, 1 or 2 sliding doors. To be fixed in VW rails behind the driver's seat, sliding for more space on driver's seat



The kitchen can also remain in the sleeping position



The cool box also fits in the large drawer

The CaliCabinet furnishing module offers versatile equipment. The folding table attached in the direction of the bench seat with a mirror above it serves as a work, make-up or dining table. Above the lockable pull-out for a large 35-litre compressor cooler (optional) is a drawer for cutlery and other utensils, supplemented by a pull-out shelf as an additional work surface or shelf for the gas cartridge stove above. The top storage compartment with shelf offers enough space for lots of crockery and supplies. The ability to slide lengthways means that any driver can sit comfortably and relax. Even with the kitchen section fitted, the full bed length is available.

The CaliCabinet can be removed in no time at all without tools and can also be used in the awning or under the awning

Cali cupboard equipment:

- Mobile 1-burner gas cartridge stove
- Folding table
- Mirror
- Heavy-duty pull-out for optional 35-litre Dometic compressor cooler
- Drawer for crockery and cutlery with pull-out shelf

Dimensions: W 635 x H 1210 x D 665 mm
(table height 710 mm, carcass width 410 mm)
Pearl wood finish **11121** **2169,-**

Accessories for CaliCook and CaliCabinet:



Dometic Coolbox Coolfreeze CDF 36; 35 l
711500 576,31

Decorative material shown is not included.

FLEX KITCHEN WITH GAS SYSTEM - VW T6.1/T6/T5

For Volkswagen T6/T5 estate, short or long wheelbase

Removable kitchen parts

- Removable and (optionally) swivelling kitchen section for installation behind the front passenger seat
- With 1-burner cooker/sink combination for 2.8 kg gas cylinder
- Convenient cooking outside the vehicle
- No odour nuisance in the interior
- Plenty of storage space, large drawer
- The kitchen unit can stay at home during everyday use

Removable kitchen section for installation behind the passenger seat in VW T5/T6 Kombi/Caravelle (not suitable for Multivan and California Beach). In combination with a Reimo sleeping bench V3000 the full bed length can be used.

Various application possibilities:

- Fixed in the vehicle in Reimo floor rails
- Swung outwards (optional)
- Set up separately for outdoor cooking

For operation in the vehicle, gas box ventilation through the vehicle floor is mandatory.

Removable kitchen section for installation behind the passenger seat in VW T5/T6 Kombi/Caravelle (not suitable for Multivan and California Beach). In combination with a Reimo sleeping bench V3000 the full bed length can be used.



Pot and pan not included

Various application possibilities:

- Fixed in the vehicle in Reimo floor rails
 - Swivelled outwards (optional)
 - Set up separately for outdoor cooking
- Gas box venting through the vehicle floor is mandatory for in-vehicle operation.

Equipment:

- ① Cooker/sink combination with glass cover
Permanently installed 1-burner gas cooker, stainless steel sink with tap Ø 240 mm, depth 125 mm
- ② Water system with submersible pump (connection to 12 V socket) and one 10 litre fresh and one 10 litre waste water canister each
- ③ Integrated gas box for a 2.8 kg Campingaz gas bottle
- ④ 1 drawer for cutlery and crockery, 1 storage compartment for small items
- ⑤ 2 side folding tables 388 x 295 mm
- ⑥ 1 clip-on shelf 350 x 260 mm
- ⑦ 2 handles for easy lifting

Kitchen section pre-assembled with built-in technology and fastening material for Reimo floor rails. Without swivel unit, please order separately.

Overall dimensions: W 595 mm (tables folded down) x H 730 x D 450 mm (plus canister 75 mm)

Furniture decor:

Installation in direction of travel right

High-gloss white	11110	1889,-
High gloss silver	11110S	1995,-
Matt black	11110B	2098,-

Pivot system see page 27



Back cover

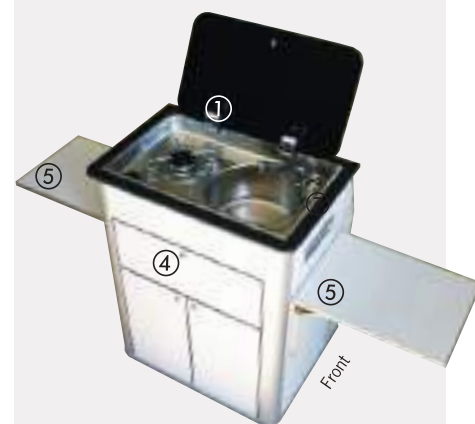

Installation in the vehicle enables the vehicle to be registered as a motorhome in accordance with EU and German registration regulations (in conjunction with a sleeping bench)

MULTIFUNCTIONAL KITCHEN PART "EASY-KITCHEN"

For Volkswagen T6/T5 Kombi, kR or IR and Mercedes Vito long Kombi



For installation behind the passenger seat in the Mercedes Vito. In combination with a Reimo sleeping bench V3000 the full bed length can be used.



Flexible kitchen part

- Removable kitchen section for installation behind the driver's or passenger seat
- Can be swung outwith optional swivel fitting
- With stainless steel sink and water system
- Convenient cooking outside the vehicle
- No odour nuisance in the interior
- Plenty of storage space, large drawer
- The kitchen block can stay at home in everyday use.

Kitchen part for installation right/left behind driver's cab seats in VW T5/T6 Kombi/Caravelle in combination with a Reimo sleeping bench V3000 (not suitable for Multivan and California Beach).

Various application possibilities:

- In the vehicle, fixed in Reimo floor rails
- Swivelled outwards (optional)
- Separate for cooking outdoors or in an awning

Equipment:

- ① Stainless steel sink
- ② Pull-out tap with shower hose
- ③ Water system with submersible pump (connection to 12 V socket) and a 10 litre fresh water and waste water canister each
- ④ 1 drawer for cutlery and crockery
- ⑤ 1 storage compartment for pots and dishes
- ⑥ Storage compartment for gas cartridge stove
- ⑦ 2 side folding tables 388 x 295 mm
- ⑧ 2 handles for easy lifting

Kitchen section pre-assembled with built-in technology, including fixing material for Reimo floor rails.

Overall dimensions: W 595 mm (tables folded down) x H 730 mm x D 450 mm (plus canister 76 mm)

Furniture decor:

high gloss white		
for mounting on the right	11112	1685,-
for assembly left	11113	1789,-
High gloss silver		
for mounting right	11112S	1789,-
for mounting left	11113S	1789,-
Matt black		
for mounting right	11112B	1889,-
for mounting left	11113B	1889,-

- ⑨ **Matching swivel unit for Flex and Easy kitchen** (for installation on the B-pillar with suitable tools)

for VW mounting right	11114	499,-
for VW mounting left	11115	498,99
for Mercedes Vito (only possible for Easy)	571112	498,99

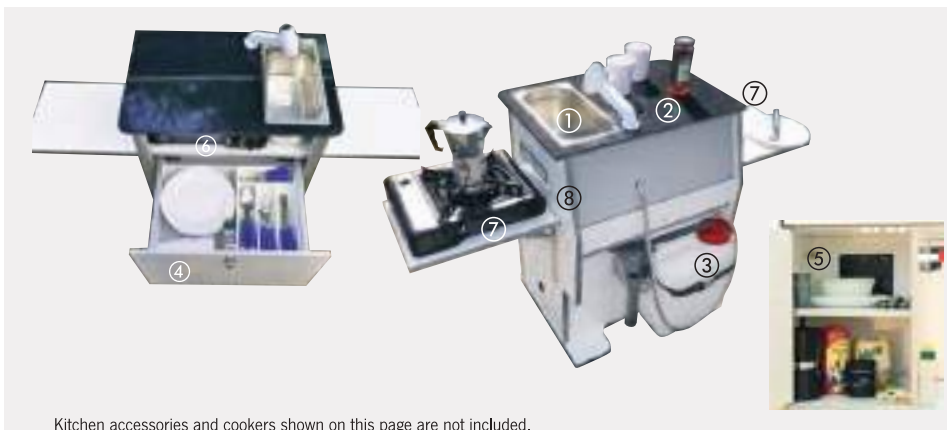

Kitchen accessories and cookers shown on this page are not included.

MULTIFUNCTIONAL KITCHEN MODULES - VW T6.1/T6/T5

- With these components you can quickly and easily transform your VW Multivan, California Beach or Weekender into a practical and comfortable camper
- Complete basic camping equipment
- Elegant furniture with distinctive, rounded aluminium edges
- Fastening of the kitchen section in the seat fastening rails
- Plenty of storage space, large drawer



Suitable for installation in the following vehicles:

- VW T6/T5 Multivan & California Beach Kombi kR o. IR
- Reimo Weekender based on: VW T6/T5, Renault Trafic, Opel Vivaro B Kombi, Fiat Talento, Nissan NV300, as of Bj. 7/2014



Features:

With complete basic camping equipment. 2x12-litre canisters for fresh water and waste water are housed in the rear part of the kitchen section and are concealed by the backrest of the cab seat.

Each kitchen section is equipped with a drawer and a spacious storage compartment. A folding table can be fitted either on the right or left, so the kitchen sections can be used on the driver's or passenger's side.

Noble furniture construction with distinctive, rounded aluminium edges at the front. Fastening in the seat mounting rails. The kitchen section fits exactly between the front edge of the bench seat (which has been converted into a bed) and the front seats. Dimensions: H73 x W65 x D48,5 cm. With sink, glass cover and technology. Installed ready for connection with 12 V plug. (Weight approx. 35 kg).

Furniture decor:

- | | | |
|-----------------------|---------|--------|
| ① Anthracite Metallic | 11100T | 1272,- |
| ② High gloss black | 11100TB | 1318,- |
| ③ High gloss white | 11100TW | 1318,- |
| ④ High gloss silver | 11100TS | 1318,- |



KITCHEN MODULE FOR VW CALIFORNIA BEACH

For Volkswagen T6 /T5 California Beach and Multivan

Kitchen"France

- **Professional "mini kitchen" for your California Beach**
- **2-burner gas cooker**
- **Space for 1x 2.8 kg gas bottle in the elegant cooker cabinet**

Compact 2-burner gas cooker. Adds a cooking facility to your California Beach. The cooker cupboard blends harmoniously into the vehicle appearance. The gas box is located in the lower part of the "mini kitchen". This offers space for a 2.8 kg Campinggaz bottle. The necessary and prescribed drop gas opening is led through the vehicle floor (40 mm). Additional storage compartment above the gas bottle.

Kitchen section with cooker, glass cover and technology. Installed ready for connection and prepared for installation in the vehicle
Dimensions: H737 x W510 x D390 mm.

Furniture decor:

Anthracite Metallic	11103T	1425,-
High gloss white	11103TW	1468,-
High glossblack	11103TS	1468,-



COMPACT KITCHEN PART FOR VW MULTIVAN

For Volkswagen Transporter T4 Multivan My.1996 - 2000

- ① **Finishedpart** Finished furniture part with spacious cutlery drawer, door, shelf, fold-down cooker shelf, space for sink and water system for fresh water, waste water, (12 litres each), pump, tap. Spacious cutlery drawer, door and 1 shelf (without cooker).

Dimensions: approx. W49 x H85 x D54 cm
10924 1024,-

Installation in the vehicle 10470 99,-

Suitable accessories:

- ② **Water system with sink**
and 2x 12-litre water cans, fixings, water pump/tap, installation material for water system, 12-volt connection
60007 299,-

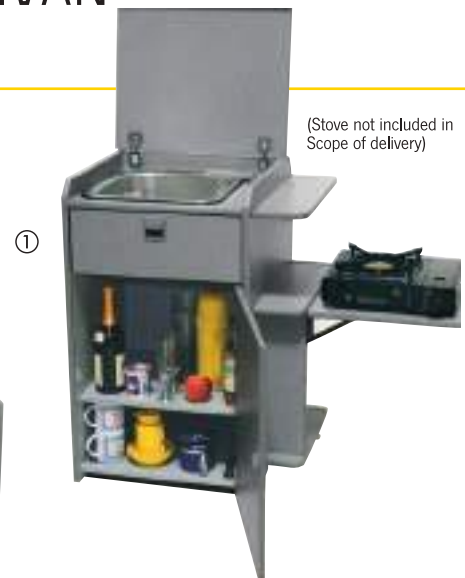

Water system for kitchen part compact

REIMO VAN-CONCEPT

REIMO MINICAMPER

The complete camping equipment for vacation and leisure in a minivan.
Despite camping equipment on board, you can use your vehicle to the full extent of everyday life.
So nothing stands in the way of your individual use .

– CONTENTS –

REIMO CAMP FOR VW CADDY MAXI	32-33
REIMO WEEKENDER FOR VW CADDY	34-35
REIMO SMILE FOR VW CADDY.....	36-37
REIMO ACTIVE FOR VW CADDY	38-39

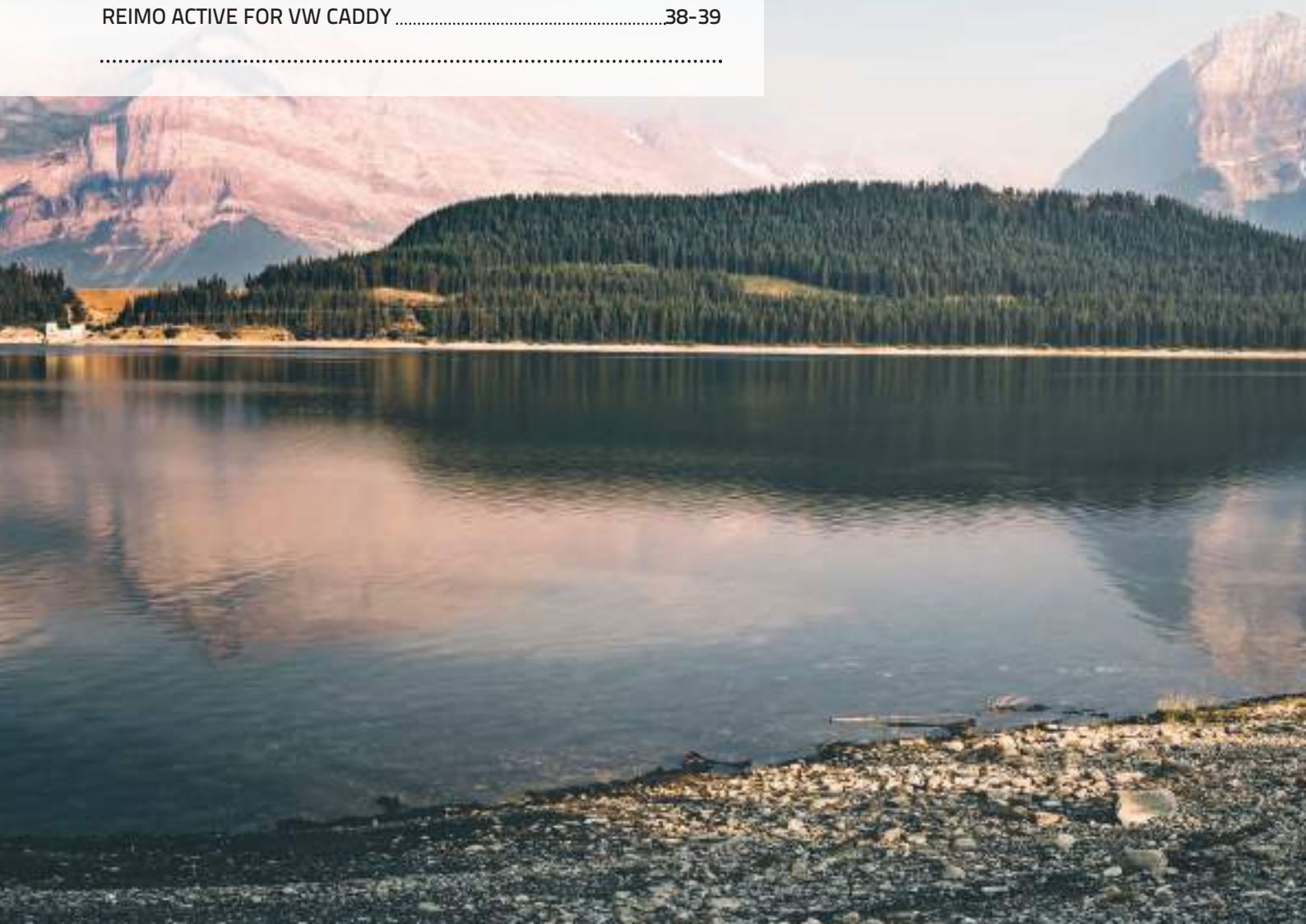



VW CADDY MAXI - CAMP

Based on Volkswagen Caddy Maxi (long wheelbase) built 2015 - 8/2020

Mini camper with complete equipment

- Fully-fledged 5-seater despite built-in furniture line
- With complete camping equipment for holidays and everyday life
- Generous storage space

The perfect companion for holidays and everyday life. Despite camping equipment, the Camp can be used as a fully-fledged 5-seater in everyday life and offers extremely generous storage space. The camping equipment remains on board without interfering with everyday use.

With a compact overall height of only approx. 1.96 m with the sleeping roof fitted (optional), it also fits into almost all multi-storey car parks, for example, and is allowed inside where other campers have to "stay outside". Visit fantastic sites with your camp and enjoy your holiday with the whole family with the sleeping roof open (optional).



Driving and travelling

- Caddy-side 5 seats with three-point seat belts remain fully intact.

Sleeping

- Level, comfortable bed with comfort slatted frame and generous, padded sleeping surface

Living

- Entry through side sliding door
- Living bench for 2 persons in the rear
- Kitchen unit with sink

Drawers and storage space

- Variable loading space size due to fold-up folding/seat bench
- Optional storage box with plenty of space
- Large storage space in the rear of the vehicle. Conveniently accommodates all your holiday luggage



Technical specifications

Sleeping places on lying surface:	2 Light
Bed dimension kR:	200 x 113 cm
Bench seat:	Original VW
Seats with three-point belts:	5

Living bench for 2 persons in the rear
Kitchen block with sink

Fresh/waste water: 2 x 13 litres
CoolFreeze CDF 18 cool box: approx. 18 litres
Original VW Caddy interior panelling
Floor plate in the rear of the vehicle to accommodate Furniture unit, storage box and bed/folding bench seat

Variable load compartment size due to fold-up folding/seat bench
Optional storage box with plenty of space, e.g. for Porta Potti (original rear bench is then removed)

Original Caddy 12 V system with interior lighting
2. Battery 60 Ah

Base vehicle:

Suitable for VW Caddy Maxi Trendline, Comfortline and Highline with original plastic trim

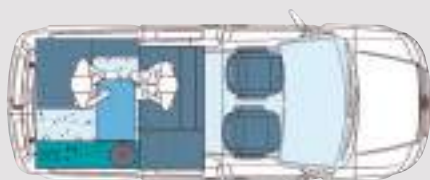

Daytime position



Night position



Camp furniture line High gloss white Including assembled technology, consisting of: 12 V system with 60 Ah Green Power battery, Reimo safety panel 714; LED line light Mini 12 V, canister water system with 2x 13 litres, stainless steel sink round, CoolFreeze CDF 18 cool box. For Caddy Maxi Kombi without shaped headliner

13501T 4115,-

For Caddy Maxi Estate Trendline, Comfortline and Highline with moulded headlining

135011T 4115,-

230-volt system mounted in furniture line Carbest switch-mode charger 15 A, automatic circuit breaker 13 A with FI, signal lamp 230 V. 230 V built-in socket with frame. With CEE socket including cable for laying and connection in the vehicle (self-installation).

135011TE 526,-



Camp bed with folding bench high gloss white, upholstery: titanium black. Can only be used in combination with the Camp furniture unit. Sleeping surface 200x113 cm

13502 1345,-

Camp base plate, decor ship's floor

13500 249,-



Camp storage box (optional) for Caddy KR and Maxi LR from Sept. 2010. Can be used for Camp, Active and Smile extensions. Can be exchanged without tools for the removable original 2-seater bench seat in the 2nd row. Additional storage volume 115 litres. Can be used with or without removal.

13505 515,-



Storage box for portable toilet

The storage box is used instead of the single seat on the passenger side. It offers space for the Porta Potti 335 Cube. Or for other utensils such as shoes, tools, etc. Can be exchanged without tools for a removable single seat. (Toilet optional)

13507 365,-

Upholstery **135070 144,-**

Porta Potti 335 Cube **660102 144,95**



Camp table set decor Mandarin, anthracite

13503 233,-



White installation box for parking heater Ateso Alfa, as prefabricated part

13506 257,72



Parking heater Ateso Alfa

48119 649,-

Digital control unit **48130 139,90**

Manual control panel **48131 109,90**

Tank extraction set 707191 107,50



S230 V induction cooker

70443 59,90

REIMO WEEKENDER - VW CADDY

Based on Volkswagen Caddy Maxi long wheelbase, year of manufacture 2015 to 8/2020

Maneuverable. Compact. Flexible.

The VW Caddy Weekender adapts perfectly to your needs. In everyday life it is a full 5-seater. At weekends or on holiday, the flat XXL double bed can be used. This can also be configured as a single bed on one side. The bed can be folded up on both sides for maximum loading volume (e.g. for bicycles). A 12 V system with interior lighting is available as an option. Further equipment options, such as a sleeping roof (cannot be installed yourself) for more sleeping space and standing height, give you plenty of design freedom!

- Mini camper with variable camping equipment
- For VW Caddy Maxi LR built 2015 - 8/2020
- Small and manoeuvrable - ideal for city traffic
- Two sleeping options:
Can be used with single bed or double bed
- Optionally with sleeping roof
- Cosy 2 - 4 person seating area with table
- Porta Potti accommodation
- High sleeping comfort thanks to level sleeping surface





Long, day position

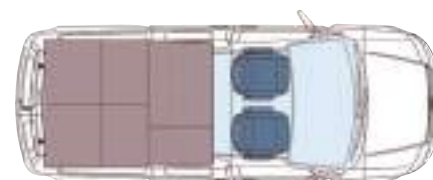

Long, night position



Sleeping

The fold-up, comfortable rear bed for the VW Caddy Maxi LR (built 2015 to 8/2020) extends over the entire interior width of the vehicle and offers a sleeping area of approx. 200x145 cm. The 2-person bed surface can be divided in the middle. Used as a single bed, there is still plenty of space next to it, e.g. for sports equipment. The fold-up bed can always remain installed in everyday use, even for larger transport tasks or with 5 people on board.

Rear bed 13602 2379,47

Living

With the folding bench seat and seating opposite, this makes a cosy 2-4 person seating area.

Entry through the sliding door is possible on the right or left. Standing height is achieved by the optional sleeping roof. For a high degree of flexibility, a table top can be mounted either on the right or left.

Table top 70 x 44 cm, Mandarin decor, anthracite

13503 233,-

Floor plate 13500 249,-

Loading and storage space

The bed folds up on both sides to create maximum loading volume (bicycle, etc.), and there is also storage space under the bed level. Max. Rear storage space with built-in equipment: approx. 2.4 m³.

Optionally available

- Large stowage box to exchange for VW 2 bench for more stowage space of 115 litres .

13505 515,-

- Box for Porta Potti camping toilet to exchange against VW single seat behind co-driver

Storage box 13507 365,-

Upholstery 135070 144,-

Porta Potti 335 Cube

660102 144,95

On-board technology

Standard with original Caddy 12 V system and interior lighting.

Optionally available:

- 230 V system mounted** Carbest Switch-Mode charger 15 A, automatic circuit breaker 13 A with FI, Signal lamp 230 V. 230 V built-in socket with frame. With CEE socket including cable for laying and connection in the vehicle (self-installation) **135011TE 526,-**

- Parking heater Ateso Alfa** **48119 649,-**

Control unit parking heater
Manual **48131 109,90**
Digital **48130 139,90**

REIMO SMILE / SMILE C PLUS - VW CADDY

Based on VW Caddy Kombi/Life kR, built 2003 to 2019 / Maxi IR built 2008 to 8/2020

Maximum spontaneity

- Comfortable, flat bed for 2 persons
- Boot volume remains the same with the bed installed
- Installed and removed in a few easy steps

With its large, comfortable bed, the Caddy Smile C Plus is ideal for spontaneous overnight stays. The backrests of the rear seats are folded down, the bed plate pulled out and the cushions placed on top. This creates an absolutely flat lying surface for 2 people in no time at all.

Storage space remains under the bed and between the bed and the front seats. No modification to the vehicle is necessary for installation. The bed stowed behind the rear seat bench can always remain installed in the five-seater. The complete extension can be installed and removed, folded compactly and stowed away to save space. The installation is carried out without having to make any changes to the vehicle.



Driving and travelling

5 full-size seats with three-point seatbelts when removed.

Level lying surface

The absolutely flat lying surface offers high sleeping comfort for 2 persons.

Bed construction in a few simple steps

In no time at all the Mini-Camper can be converted into a Bed in the mini camper. Can also be used without the rear seat bench.

Boot volume remains unchanged

For the holiday luggage there is plenty of volume under the finished bed.



Technical specifications

Sleeping places on bed surface: 2
 Light bed size KR: 200 x 120 cm
 Bench seat: Original VW
 Seats with three-point belts: 5
 Bed frame: Poplar plywood with HPL laminate
 and robust ABS edges

Storage space short wheelbase:
 approx. 510 l (with extension) - 2200 l
 (without extension, with folded bench seat)

Rear storage space under bed:
 LR: approx. 127(174*) x 108 x 50 cm = approx.
 685 - 940 l*

*with the bench seat removed
 Storage space in front of 2nd row of seats
 approx. 30 x 80 x 38 cm = approx. 90 l

Payload example:
 Base vehicle VW Caddy Maxi Conceptline engine
 1.4 l petrol:
 Permissible total mass: 2260 kg
 Payload without sleeping roof: approx. 710 kg
 Payload with sleeping roof: approx. 635 kg

Base vehicle:

Suitable for VW Caddy Kombi, Life, Maxi Trendline, Comfortline and Highline with original plastic trim



Daytime position



Night position



Retrofittable Smile bed system 200x120 cm as prefabricated part (Caddy Kombi short wheelbase) Scope of delivery: bed construction, upholstery and covers, fixing material. Décor anthracite, upholstery fabric: Classic Uni Grey.

16104

949,-

Retrofittable Smile bed system 200x120 cm as prefabricated part (Caddy Life short wheelbase) Scope of delivery: bed construction, upholstery and covers, fixing material. Décor anthracite, upholstery fabric: Classic Uni Grey.

15104

949,-



Thermomats 3-piece, for the driver's cab, from year of construction 2004 onwards

37226

62,90

Thermomats 8-pieces, complete set, from 2004 onwards

37227

139,90



Mobile shower with 20 ltr. wide-neck canister incl. submersible pump.

64132

74,90



9 litre compressor cooler VAN S Cooling capacity: -18°C to 10°C
 Dimensions W x D x H: approx. 210 x 459 x 320 mm, weight: approx. 8.5 kg. Connection: 12, 24 and 230 V, power consumption approx. 35 watts.

71354

419,-

REIMO ACTIVE - VW CADDY & SIMILAR VEHICLES

Based on VW Caddy Life / Trendline / Comfortline / Highline / Maxi

Minicamper De Luxe

- Compact camping equipment
- Extendable kitchen module
- Slatted bed for 2 persons
- Removable storage box

The Active camping extension - the perfect camping equipment for leisure and everyday vehicles
Consisting of 4 modules: base plate, collapsible bed, kitchen box with 1 stainless steel sink and Water system (12 l fresh water / 5 l waste water), shower head with hose, compartment for cooker as well as storage compartment for cooking utensils and cutlery. Storage box with 60 l volume.



Extendable kitchen module for use in or in front of the vehicle. The removable upholstery quickly transforms the kitchen module into a comfortable seat box. The 60 l storage box incl. seat cushion (opposite the kitchen box) is accessible from above and from the side. It can also be used outdoors as a seat.

Compact and functional

The compact extension with camping equipment. Ideal for your everyday vehicle.

Sitting in the rear of the vehicle

With the upholstered cushions, the kitchen module and storage box can be converted into seats

Storage space in front of the bench seat

Even with the bed set up, there is still storage space in front of the bench seat



Technical specifications

Sleeps on sleeping/seating bench: 2
 Light bed dimensions: 195 x120/130 cm
 Bench seat: Original VW
 Seats with three-point belts: 5
 Refrigerator: Space for cool box in trunk
 Furniture: Poplar plywood with HPL laminate
 Fresh water / waste water : 1x 12 l/1x 5 l
 Storage space between kitchen box and storage box: approx. 80 x 35 x 43 cm l

Payload example:

Basic vehicle VW Caddy KR Trendline
 Engine: 1.2 l petrol

Permissible total mass: 2165 kg
Payload approx. 715 kg

Base vehicle:

VW Caddy (short wheelbase, without sleeping roof) or VW Caddy Maxi (long wheelbase, sleeping roof optional)



Daytime position

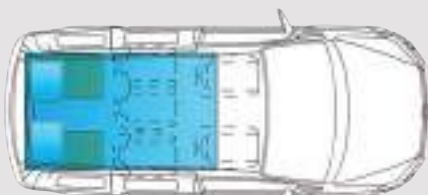

Night position

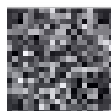

Further info about the vehicle



Active equipment is also available for Citroën Berlingo II Multispace, Peugeot Partner II Tepee, Renault Kangoo II, Mercedes Citan and Ford Tourneo Connect KR. All information available from your specialist dealer or at www.reimo.com



Active floor panel

For vehicles built after 10/2003 with short wheelbase.
 Mandatory for the construction of the bed
 Assembly without tools. Decor Granitto.

13204 249,-



Active Bed Caddy with upholstery

Including anodised aluminium tubular frame and Upholstery set, grey.
 Sleeping surface 195x 120/130 cm
 For vehicles with short wheelbase.

13205 1329,-



Kitchen box including water system

Assembly without tools, dimensions 77 x 42 x 41.5 cm decor white/olive.

13206 1449,-



Seat/stowage box 60 l

For all Reimo Minicamper short and long wheelbase. Assembly without tools, dimensions 77 x 28 x 41.5 cm decor white/olive.

13207 825,-



Porta Potti 335 portable camping toilet

Fits in the rear storage space between the furniture line. High quality plastic for maximum hygiene

660102 144,95



Thermomats 3-piece, for the driver's cab, from year of construction 2004 onwards.

37226 62,90

Thermomats 8-pieces, complete set, from 2004 onwards

37227 139,90



9 litre compressor cooler VAN S

Cooling capacity: -18°C to 10°C
 Dimensions W x D x H: approx. 210 x 459 x 320 mm, weight: approx. 8.5 kg. Connection: 12, 24 and 230 V, power consumption approx. 35 watts.

71354 419,-



Mobile shower with 20 ltr. wide-neck canister incl. submersible pump.

64132 74,90

REIMO VAN-CONCEPT

VOLKSWAGEN CAMPERVANS

Camping bus equipment for Volkswagen models - stylish & elegant

Discover the complete Reimo Van-Concept interior range for T6.1/T6/T5. From the functional furnishings to the exclusive kitchenette and the classic camper conversion for VW T3.



- CONTENTS -

BASE VW T6.1/T6/T5

TRIOLOFT	42-45
TRIOSTYLE	46-49
MULTISTYLE	50-53
SPORTCAMPER	54-57
TRAVELSTYLE	58-61
CITYVAN	62-65
WEEKENDER PLUS	66-69
WEEKENDER	70-71
MULTIFUNCTIONAL KITCHEN PARTS	72-73
BIKE`N`SURF	74-75

BASIS VW T3

FLORIDA	76
SPEEDY	77
JOLLY	78



REIMO TRIOLOFT - VW T6.1/T6/T5

Based on Volkswagen Transporter T6.1/T6/T5 station wagon, short wheelbase



Stylish, elegant, extravagant.

- Fully equipped furniture line in exclusive design with noble high-gloss decor combination and ambient lighting
- Large window area in the bench area thanks to stylish kitchen block
- Pull-out apothecary cupboard and integrated wall units
- Sliding and tool-free removable 3-person bench seat, equipped as standard with 3 three-point belts and 2 Isofix holders
- Maximum sleeping comfort due to flat lying surface of approx. 205 x 126 cm





Perfectly formed.

The extravagant design of the furniture line with integrated wall units is just as captivating as the generous feeling of space.

The recessed tall cupboard creates an extended window area in the area of the bench seat. This means not only more light in the vehicle but also a very pleasant living ambience. The lighting concept with integrated base lighting creates a cosy atmosphere not only in the evening hours.

Optionally on board are a cooker-sink combination with glass cover, a powerful 35-litre compressor cooler and a variable Table top.

The variable space concept turns the TrioLoft into a camper van for up to 4 people, a transporter for your bikes and a recreational vehicle for all your leisure activities. With up to 7 seats, it is also ideally suited as an everyday vehicle for a large family.

Please ask your dealer for further equipment and options
Some of the illustrations show optional equipment that is not included in the scope of delivery.

REIMO TRIOLOFT - VW T6.1/T6/T5

Based on Volkswagen Transporter T6.1/T6/T5 station wagon, short wheelbase

Camping in its most beautiful form.

Stylish interior design with many practical features. Enjoy more space and window area in the bench area due to the stylishly shaped furniture line

You can expect long-distance seating comfort on the 3-person bench thanks to the ergonomic upholstery shaping. In no time at all, the bench becomes a comfortable double bed with an absolutely flat lying surface.

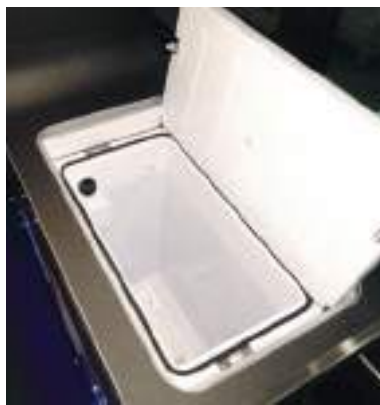

The TrioLoft offers up to 7 seats due to the retrofittable individual seats (for vehicles with glued-in floor rail)

An optional top-loader cool box with a volume of 36 litres integrated into the furniture line enables easy filling and convenient removal of the cool box contents

Optimum use of storage space: Kitchen accessories find their place in the pull-out apothecary cabinet with 3 storage compartments on the side.

Please ask your dealer for further equipment and options
Some of the illustrations show optional equipment that is not included in the scope of delivery.

Technical specifications

TrioLoft short wheelbase:

Sleeping berths on sleeping/seating bench:	2
Sleeping berths with optional sleeping roof:	4
Light bed dimension:	205 x 131 cm
Light roof bed dimension:	200 x 110 cm
Sleeping/seating bench:	Variotech 3000@
Seating with three-point seat belts:	5
Cooker:	2-burner gas stove*
Refrigerator:	Compressor cooler (approx. 30 l)*
Gas capacity:	Space for 1x 5 kg gas bottle
Furniture:	Poplar plywood with HPL laminate
Fresh water / waste water:	1x 10 l / 27 l / 20 l*
Tall cabinet:	117 x 126 x 33 cm
Rear storage space:	126 x 86 x 40 cm / 433 l
Storage space under bench:	43 x 75 x 28 cm / 90 l
Overhead locker:	97 x 36 x 9 cm / approx. 32 l

*Included in the technical package

Permissible total mass:	3080 kg
Payload:	approx. 640 kg



Daytime position

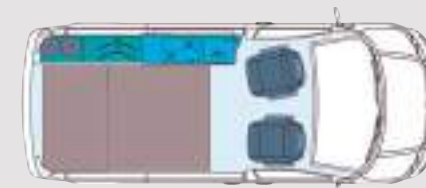

Night position





Sleeping/seating bench Variotech® 3000

Three-seater, size 10 Total width: 1205 mm, cushion width: 1155 mm, sleeping area: 205 x 126 cm, 3 integrated, retractable headrests, 3 seat belts, Isofix attachment points for a maximum of 2 child seats (middle seat cannot be used when a child seat is used), fold-up rear upholstery (storage height under rear upholstery: 46 cm), 1 side panel. Fully upholstered incl. rear cushion. Sliding and removable bench. Rail spacing 651 mm. Fabric design: Classic Grey, 2-coloured.

5040000 4249,-

"Grizzly" slide rail set For Variotech® 3000 kR

58200 426,59

Fastening set

For "Grizzly" sliderail set for short wheelbase. For fastening the slide rails to the vehicle floor. Rail spacing 651 mm.

58204 219,-



Drawer

Provides additional storage space for e.g. shoes, cables or board tools. The drawer can be removed for loading long parts. Dimensions HxWxD: approx. 17x49,5x69,5 cm. Décor: Basalt

5040090 679,-

Front panel

Installed on the bench instead of a drawer. The front panel is removable and therefore offers a through-loading possibility for e.g. surfboard or skis up to a length of max. 2,4 m. (Loading dimensions under the bench

HxW approx. 31x60 cm. Décor: Basalt

5040080 249,-



Base plate 3-pcs

made of waterproof chipboard with PVC covering. For original VW door sill. Rail spacing 651mm Décor: ship's floor

1053822 423,-

X-Trem insulator, 18 mm thickness

Extremely heat insulating and very light insulation. Is required under the base plate. Supplied as panels with a 2 x 1 m. (2x for kR)

50009 22,99



Furniture unitas finished part without technical package:

Generous furniture unit incl. tall cupboard with sliding door, linen compartment, storage compartment for 1x 5 kg gas bottles, 2 drawers. The cabinet offers a lot of space (e.g. for the chemical toilet Porta-Potti Qube 335, 660102). 3 storage compartments above the kitchen. Prepared for installation of a cool box. Furniture line without technology, appliances and installation. décor: high gloss white/olive

18090F 4049,-



Technical package built into the furniture above:

The technical package includes: Sink-cooker combination with glass cover, 1x 10-litre fresh water canister, water tap, 18-litre submersible pump and hoses, 36-litre compressor cooler, gas system prepared for 1x 5 kg gas bottle, 12 V/230 V system, Carbest switch-mode charger 20 A, 13 A circuit breaker with fl. Package ready installed in the furniture unit. Control unit PC 210 is enclosed with cable and is mounted in the console at the top of the driver's cab. CEE surface-mounted socket incl. cable for self-connection included in the scope of delivery. Without battery / we recommend 850518 AGM battery 100 AH suitable under driver's seat.

18090TSM 2739,-



Diesel heater Breeze Small, compact heater for mounting under the passenger seat. Power: 2,7 KW, fuel consumption max. 0,33 l/h. Power consumption: 74-130 W. Dimensions: L 355 x W 124 x H 126 mm

48129 699,-

Digital control panel **48130 139,90**

Manual control panel **48131 109,90**

Mounting bracket under passenger seat

48132 99,90

Fuel tank extraction set 707191 107,50



Table system with swivel table frame

With wall bracket and folding table base. Table top in laminate décor slate, approx. 85 x 47 cm. Table edge in silver.

18052 289,-



Hanging roof cupboard for EasyFit sleeping roof :

As prefabricated part above rear bench seat for additional storage space. Cabinet pre-assembled. Standard décor: High-gloss white

18091 549,-



Porta Potti 335 portable camping toilet

Suitable for TrioLoft furniture line. High quality plastic for maximum hygiene

660102 144,95

REIMO TRIOSTYLE - VW T6.1/T6/T5

Based on Volkswagen Transporter T6.1/T6/T5 station wagon, short wheelbase



5 stars on wheels.

- Exclusive, fully equipped furniture unit with kitchen part, 39l compressor fridge, wardrobe and storage compartments
- Sliding and tool-free removable 3-person bench seat, equipped as standard with 3 three-point seat belts and 2 Isofix mounts
- Top sleeping comfort due to flat lying surface of approx. 200 x 126 cm
- Up to 7 luxurious seats due to additional, retrofittable pilot seats
- Maximum flexibility due to variable living and storage space layout





Exclusive equipment.

The Reimo TrioStyle with exclusive full camping equipment embodies holiday travel and camping living comfort at the highest level.

The noble furniture line with full equipment leaves nothing to be desired even on longer trips. The comfort motorhome TrioStyle is a large-capacity limousine with plenty of room to move for 5-7 passengers in everyday life and at work (all seats with three-point seat belts) and ample storage space in the rear.

Under the folded down rear cushion there is a stowage space height of 46 cm.

In the spare time it transforms into an exclusive camping-mobile with 2-4 full sleeping berths (sleeping roof optional).

Please ask your specialist dealer for further equipment and options. Equipment for the long wheelbase can be found At: www.reimo.com. Some of the illustrations show optional equipment that is not included in the scope of delivery.



REIMO TRIOSTYLE - VW T6.1/T6/T5

Based on Volkswagen Transporter T6.1/T6/T5 station wagon, short wheelbase

Travel without compromise.

The exclusive kitchenette offers storage space for a 39 litre compressor fridge (Dometic CRP40) as well as a storage compartment with elegant roll-up door for a Porta Potti 335 camping toilet.

The installation of 2 sockets (1x 12V, 1x 230V) is provided on the side wall of the cupboard. The control panel for an optional Truma ECO gas heater is also fitted in the same position is carried out. 2x 5 kg gas bottles find their safe place in the rear of the vehicle.



A clever extension highlight is the storage compartment flap, which is integrated into the underside of the bed. It allows quick access to travel utensils and luggage in the boot from the vehicle interior, when the bench seat is converted into a sleeping bench.

This means you don't necessarily have to leave the vehicle, which is particularly practical in bad weather.

Technical specifications

TrioStyle short wheelbase:

Sleeping berths on sleeper/seat bench:	2
Sleeping berths with optional sleeping roof:	4
Clear bed dimension:	205 x 131 cm
Roof bed dimension:	200 x 120 cm
Sleeping/seating bench:	Variotech® 3000
Seats with three-point belts:	5
Cooker:	2-burner gas stove*
Refrigerator:	Compressor fridge Dometic CRP 40 (approx. 39 l)*
Gas capacity:	Space for 2x 5 kg gas bottle
Furniture:	Poplar plywood with HPL laminate
Fresh water / waste water:	2x 12 l or 49l fresh water tank / 27 l*
tall cupboard:	117 x 126 x 33 cm
Overhead cabinet:	97 x 36 x 9 cm / approx. 32 l
Rear storage space:	
- with / without bench seat:	2600 l / 4300 l
- under bed extension:	DxWxH 63x112x40 cm
- under bench:	43 x 75 x 28 cm / 90 l

*Included in the technical package

Permissible total mass:	3000 kg
Payload without sleeping roof:	approx. 640 kg
Payload with sleeping roof :	approx. 580 kg

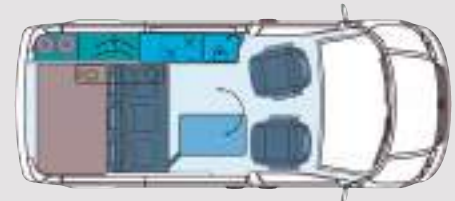

Daytime position

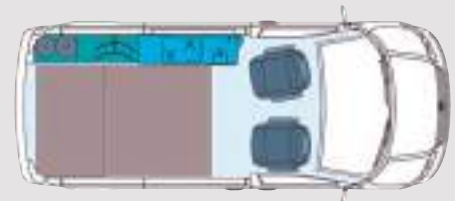

Night position



For further equipment and options, please contact your specialist dealer. Equipment for the long wheelbase can be found at: www.reimo.com. Some of the illustrations show optional equipment that is not included in the scope of delivery.



Sleeping/seating bench Variotech® 3000

Three-seater, size 10 Total width: 1205 mm, cushion width: 1150 mm, sleeping area: 2000x1250 mm. 3 integrated, retractable headrests, 3 safety belts, Isofix attachment points for a maximum of 2 child seats (middle seat cannot be used when a child seat is used), fold-up rear upholstery (storage space height under rear upholstery: 46 cm), 1 side panel. Fully upholstered incl. rear cushion. Sliding and removable bench .Rail spacing 651 mm. Fabric design: Classic Grey, 2-coloured.

5040000 4249,-

"Grizzly" slide rail set For Variotech® 3000 kR

58200 426,59

Fastening set For "Grizzly" sliderail set for short wheelbase. For fastening the slide rails to the vehicle floor. Rail spacing 651 mm.

58204 219,-



Drawer optionally available

Provides additional storage space for e.g. shoes, cables or board tools. The drawer can be removed for loading long parts. Dimensions HxWxD: approx. 17x49,5x69,5 cm. Decor: Basalt

5040090 679,-

Front panel optionally available

Can be mounted on the bench instead of a drawer. The front panel is removable and therefore offers a through-loading possibility for e.g. surf-board or skis up to a length of max. 2.4 m. (Loading dimensions under the bench HxW approx. 31x60 cm. Decor: Basalt

5040080 249,-



Base plate 3-pcs

made of waterproof chipboard with PVC covering. For original VW entrance rail. Rail spacing 651mm Décor: ship's floor

1053822 423,-

X-Trem insulator, 18 mm thickness

Extremely heat insulating and very light insulation. Is required under the floor slab. Supplied as panels with a 2 x 1 m. (2x for kR)

50009 22,99

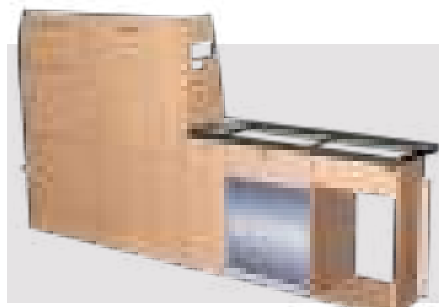

Furniture unit as finished part without technical package

For VW T6/T5 short wheelbase .Generous furniture part incl. tall cupboard with sliding door, linen compartment, storage compartment for 2x 5 kg gas bottles. 2 drawers. A roll-up cupboard offers plenty of space (e.g. for the Porta-Potti Qube 335 chemical toilet, 660102). Furniture unit without technology, appliances and installation. Dimensions LxD approx. 236x35 cm. Decor: apple laminate.

18050 3639,-



Technical package built into the furniture above

The technical package includes: Sink-cooker combination with glass cover, 2x 12 l fresh water canister, 27 l waste water canister, water tap, submersible pump 18 l and hoses, compressor refrigerator (Dometic CRP 40, approx. 39 l), gas system prepared for 2x 5 kg gas bottle. 12 V/ 230 V system with Reimo fuse panel 714, Carbest switch-mode charger 15 A, circuit breaker 13 A with Fi, CEE input socket and connection parts. 24 LED aluminium line light in kitchen part.

191005E 3659,-



Truma VarioHeat eco gas heater Fitted in furniture unit, incl. chimney. The opening for the chimney as well as the chimney must still be attached to the vehicle.

720304E 2431,22



Table system with swivel table frame With wall bracket and folding table base. Table top in laminate decor slate, approx. 85 x 47 cm. Table edge in silver.

18052 289,-



Hanging roof cupboard for EasyFit sleeping roof with slatted bed As a prefabricated part above rear bench seat for additional storage space. Cabinet pre-assembled. For short or long wheelbase with decor: apple laminate

180541L 419,-



Porta Potti 335 portable camping toilet

Suitable for furniture line .High quality plastic for maximum hygiene

660102 144,95

REIMO MULTISTYLE - VW T6.1/T6/T5

Based on Volkswagen Transporter T6.1/T6/T5 station wagon, short wheelbase



Camping bus with two Single beds and WC compartment

- The 2 single seats can be easily folded down to comfortable single beds with a flat lying surface (1x 200x65 cm, 1x 190x65 cm)
- Highest privacy due to separate WC compartment with cassette toilet and own water supply
- Side galley with 39 litre compressor fridge, 2-burner stainless steel cooker and sink with chic glass cover
- An optional pop-up sleeping roof offers standing height in the rear of the vehicle, very comfortable for cooking and living





The 2-room living concept.

The Reimo MultiStyle is the perfect symbiosis of everyday utility, comfortable single seats and single beds, as well as a separate toilet WC compartment.

Newly developed are the lush single seats, which can be folded down to 2 single beds (200/190 x 65 cm) in just a few steps and also offer a large storage space in the rear.

The passage to the permanently installed Thetford toilet always remains free, even when the beds are made up. A door separates the living area from the bathroom and ensures maximum privacy

The side rear kitchen is fully equipped with fridge, sink, cooker and storage compartments.

MultiStyle - the perfect all-rounder for holiday trips for two or the spontaneous city trip over the weekend.

For further equipment and options, please contact your specialist dealer. Equipment for the long wheelbase can be found at: www.reimo.com. Some of the illustrations show optional equipment that is not included in the scope of delivery.



REIMO MULTISTYLE - VW T6.1/T6/T5

Based on Volkswagen Transporter T6.1/T6/T5 station wagon, short wheelbase

Van for two.

The 2 lush individual seats and the turned cab seats (available as an option) form a generous, homely 4-seater seating group. The passage to the kitchen and the toilet compartment remains free. The table top can be moved flexibly in the vehicle thanks to the swivel system.

The fully equipped kitchen section with 2-burner hob, sink, compressor fridge and ample storage space leaves nothing to be desired when camping.



Maximum privacy on the road: the toilet compartment in the rear with a ready toilet is separated from the living area by a door when in use. Stowage compartments offer sufficient space for stowing bath and hygiene articles

A 27 litre fresh water tank as well as a 12 litre waste water tank can be installed optionally. If desired, an additional hot water with connection of an outdoor shower is available on request.

Please ask your dealer for further equipment and options. Equipment for the long wheelbase can be found at: www.reimo.com. Some of the illustrations show special which are not included in the scope of delivery.

Technical specifications

MultiStyle short wheelbase:

Clear bed dimension below:	200x65/190x65 cm
Light bed dimension roof bed (option):	190 x 120 cm
Seat bench type:	V 1000
Seating capacity:	4
Refrigerator:	39 l compressor refrigerator
Gas supply:	2x 5 kg Fresh water:
	30 l
Waste water :	12 l canister
Storage space in the seat base under the individual seats, access from above and front flap:	2x 68 l
Wardrobe:	140/185 l
Floor cupboard:	50/75 l
Wall cupboard in WC compartment	
Storage space behind the single seats:	2x
Storage compartment in front of wardrobe:	60 l
Storage compartments in furniture line	

(data according to manufacturer)

Vehicle length	approx. 4,89 m
Vehicle width	approx. 1,91 m
Vehicle height without roof	approx. 1,93 m
Vehicle height with roof	approx. 2,00 m

Loading example:

Basic vehicle Volkswagen T6 station wagon	
Engine: 2,0 l Diesel	
Permissible total mass:	3000 kg
Payload without sleeping roof:	approx. 610 kg
Payload with sleeping roof:	approx. 550 kg

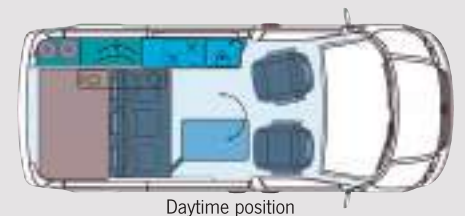



Single seats V1000

Comfortable single seats with a total width driver side left with 660 mm and passenger side right 680 mm. Comfortable single beds with a sleeping surface of 200 x 65 cm and 190 x 65 cm.

The single beds provide free access to the rear and allow you to get up without disturbing the other person. Further the single seats offer a storage space of approx. 86 l under each seat. Scope of delivery: 1 single seat right and 1 single seat left. Incl. belts, fastening material, trim and additional upholstery for cab seats. Decor seat trim: Apple. Decor seat cover: Austin T6

58350KA 4266,90



Bed widening The middle section serves to enlarge the sleeping surface in the area of the shoulders. Scope of delivery incl. upholstery. Decor: apple laminate.

58352V 205,-



Base plate 1-piece

made of waterproof chipboard with PVC covering. For original VW door sill. Decor: ship's bottom

105251 379,-

X-Trem insulator, 18 mm thickness.

Extremely heat insulating and very light insulation. Is needed under the floor panel 2x for kR. Supplied as panels with a 2 x 1 m.

50009 22,99



Furniture line as finished part without technical package: (Fig. shows furniture line incl. technical package) Generous kitchen part with cutlery drawer and plenty of storage space for crockery. Due to the large work surface the kitchen unit is prepared for cooker-sink combination. Storage compartment for 2x 5 kg gas bottles. The toilet compartment in the rear on the passenger side is prepared for the installation of a CTW 4110 cassette toilet. The door also serves as a partition to the living area or closes off the toilet compartment. The wardrobe has a storage compartment and a further cupboard compartment underneath. The toilet compartment is supplied as a kit for installation in the vehicle. Kitchen unit without technology, appliances and installation. Decor: apple laminate

Kitchen section 19110 2069,-

Clothes/toilet cupboard 19111 1759,-



Fig. shows optional high-gloss white version

Technical package built into the above furniture unit

The technical package includes: Sink-cooker combination with glass cover. Compressor fridge (Dometic CRP 40, approx. 39 l). Gas system prepared for 2x 5 kg gas bottles. 12 V/230 V system with Reimo fuse panel PC210, Carbest switch-mode charger 15 A, automatic circuit breaker 13 A with FI, CEE input socket and connection parts as well as LED light are included and must be installed in the vehicle. Without battery

19122 3973,37

Cold water system

Water system with 27 l fresh water tank, 12 l waste water canister, water tap, submersible pump 18 l and small parts. The 27 l fresh water tank is supplied assembled with all connections. Installation in the side wall opposite the sliding door

19118 664,-

Hot water system Additionally with hot water boiler Elgena 3 l.

19119 1329,-

Shower set mounted (see picture left side) The shower set consists of socket with pre-mixer 63220 and hand shower 63226 and is mounted on the side of the kitchen unit facing the tailgate

19117 409,-



Truma VarioHeat eco gas heater

Fitted in furniture unit, incl. chimney. The opening for the chimney as well as the chimney must still be attached to the vehicle.

19120 1989,-



Table system with swivel table frame

With wall bracket and swivel table base. Tabletop in laminate decor slate, approx. 75x48 cm, table edge in silver.

18052 289,-

Folding table incl. panelling

Delivery includes folding brackets and panelling to which the folding table is attached. Size of 86 x 38 cm. The delivery is made as a kit for assembly. Décor: apple laminate

19112 269,-



Cassette toilet CTW 4110 The elegant, lightweight toilet with scratch-resistant ceramic inlay. The seat can be rotated 90° in both directions. Integrated 19 l waste water and 7 l fresh water tank.

662621 874,-

REIMO SPORTCAMPER - VW T6.1/T6/T5

Based on Volkswagen Transporter T6.1/T6/T5 station wagon, short wheelbase



The sporty classic in a modern guise.

- The classic camping equipment in a shapely look with space for a large 45L compressor fridge incl. ice compartment
- Permanently mounted 3-person bench seat with 2 IsoFix holders and retractable headrests
- Double bed with level lying surface, sleeping width 190 x 126 cm
- Fully suitable as an everyday vehicle





The youthful leisure type.

Reimo SportCamper -
The classic camper with a modern and functional interior.

Equipped with the 3-person comfort sleeping bench Variotech® 3100, large furniture unit with kitchen section, wardrobe, storage compartments and swivel table, even the basic version of the SportCamper offers all the prerequisites for a perfect camping holiday.

With its 5 seats, it even offers enough space for the entire family on trips and camping holidays.

Please ask your specialist dealer for further equipment and options. Equipment for the long wheelbase can be found At: www.reimo.com. Some of the illustrations show optional equipment that is not included in the scope of delivery.

REIMO SPORTCAMPER - VW T6.1/T6/T5

Based on Volkswagen Transporter T6.1/t6/T5 Kombi, short wheelbase

A lot of camper for little money.

The kitchen part with high-quality, resistant laminate surface offers especially much work surface. The kitchen is equipped with a 2-burner cooker/sink combination made of stainless steel. In the large wardrobe you can store plenty of holiday luggage.

The furniture line is completed with a gas bottle storage box in the rear, which is already equipped to hold 2x 5kg gas bottles.



The storage space in the kitchen block is perfect for holding the optional portable toilet (Porta Potti 335).

The smart cutlery drawer with sliding shelf can be used as additional storage space.

In the large wardrobe with retractable door, the table base is stowed away to save space.

In just a few steps the bench becomes a double bed. The flat sleeping surface without seams and straps ensures the highest sleeping comfort on the road.



Technical specifications SportCamper short wheelbase

Sleeps on sleeper/seat bench:	2
Sleeping berths with optional sleeping roof:	4
Light bed dimensions :	190 x 131 cm
Roof bed dimension:	200 x 120 cm
Sleeping/seating bench:	Variotech® 3100
Seats with three-point belts:	5
Cooker:	2-burner gas stove*
Refrigerator:	Cool Matic XRX 50 compressor fridge (45 l)*
Gas capacity:	Space for 2x 5 kg gas bottle
Furniture unit:	Poplar plywood with HPL laminate
Fresh water / waste water:	2x 12 l / 1 x 16 l
Tall cabinet:	117 x 126 x 33 cm
Hanging roof cupboard:	97 x 36 x 9 cm / approx. 32l

Storage space:	
- in the sliding door area:	2000 l
- under bed extension:	DxWxH 73x67x40 cm
- under the bench:	50x67x30 cm / 100 l

*Included in the technical package

Permissible total mass:	3000 kg
Payload without sleeping roof:	approx. 640 kg
Payload with sleeping roof :	approx. 580 kg

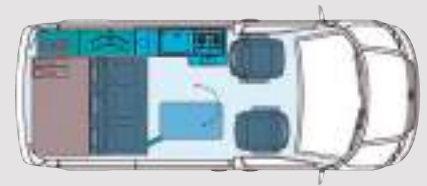

Daytime position

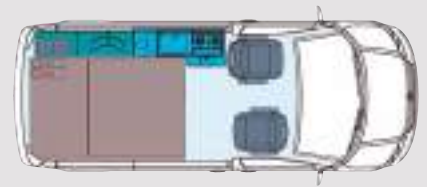

Night position



For further equipment and options, please contact your specialist dealer. Equipment for the long wheelbase can be found at: www.reimo.com. Some of the illustrations show optional equipment that is not included in the scope of delivery.



Sleeping/seating bench Variotech® 3100 rigid: Three-seater, total width: 1205 mm, upholstery width: 1150 mm, sleeping surface: 1900x1310 mm. 3 integrated, retractable headrests, 3 safety belts (size 10). For a maximum of 2 child seats (middle seat not usable when using a child seat). Fold-up rear upholstery (storage space height under rear upholstery: 46 cm), side panel. Fully upholstered incl. rear cushion Sleeper/seat bench not removable. Fabric design: Classic Grey, 2-colour.

5040600 3869,-

Mounting material for bench seat

Carrier 1	582081	32,95
Carrier 2	582082	34,05
Carrier 4	582084	291,50
Mounting kit	58208	89,90



Drawer

Provides additional storage space for e.g. shoes, cables or board tools. The drawer can be removed for loading long parts. Dimensions HxWxD: 17x49,5x69,5 cm. Décor: Basalt

5040690 549,-

Front panel

Installed on the bench instead of a drawer. The front panel is removable and therefore offers a through-loading possibility for e.g. surfboard or skis up to a length of max. 2,4m. (Loading dimensions under the bench HxW approx. 31x60 cm. Décor: Basalt

5040680 259,-



Base plate 1-piece

made of waterproof chipboard with PVC covering. For original VW door sill. Décor: ship's bottom.

105251 379,-

X-Trem insulator, 15 mm thickness.

Extremely heat insulating and very light insulating. Is needed under the floor panel 2x for KR. Supplied as panels with a 2 x 1 m.

50009 22,99



Furniture unit as finished part without technology package

(Fig. shows furniture unit in Granitto decor) consisting of: Clothes/laundry cupboard with retractable door, additional laundry and storage compartments in the rear area. In the gas box there is space for 2x 5 kg gas bottles. Kitchen section with space for 2-burner cooker and sink (800 x 320 mm) stainless steel, robust worktop in HPL laminate, plenty of space in storage compartments and drawer, space for refrigerator (see technical package). Swivel table system with attachment to the bench, compartment for Porta Potti Qube 335 (660102). Cut-outs for the installation of gas, water, hot air, electricity and other assembly preparations have already been made. Décor: Apple laminate, edges in silver.

104900 2199,-



Technology package built into the above furniture unit

The technical package includes: Sink-cooker combination (800 x 320 mm) stainless steel, 2x12 l fresh water canister and 1x16 l waste water canister, water tap, submersible pump 18 l, compressor fridge Cool Matic CRX 50 (45 l), gas system prepared for 2 kg gas bottles, 12 V/230 V system with Reimo fuse panel 714, Carbest switch-mode charger 15 A, circuit breaker 13 A with Fi, 1x built-in socket 12 V and 1x built-in socket 230 V, CEE input socket is supplied but must be mounted in the side wall of the vehicle. We recommend AGM battery 100 Ah (850518) suitable under driver's seat. Décor: apple laminate. Edges in silver.

10496 5069,-



Truma VarioHeat eco gas heater

Fitted in furniture unit, incl. chimney. The opening for the chimney as well as the chimney must still be attached to the vehicle.

720304E 2431,22



Table system with swivel table frame

mounting on the bench. Table top laminated wood decor slate, incl. fixing screws, approx. 75x48 cm. Table edge in silver

18052 289,00



Hanging roof cupboard for EasyFit sleeping roof with slatted bed:

As a prefabricated part above rear bench seat for additional storage space. Cabinet pre-assembled. For short or long wheelbase with decor: apple laminate

104941 379,-



Portable camping toilet Porta Potti 335

Suitable for SportCamper furniture line. High-quality plastic for maximum hygiene

660102 144,95

REIMO TRAVELSTYLE - VW T6.1/T6/T5

Based on Volkswagen Transporter T6.1/T6/T5 station wagon, short wheelbase



Motorhome in van format.

- Spacious furniture unit with large kitchen block, 45l compressor fridge, wardrobe and toilet compartment
- 3-person bench seat, equipped as standard with 3 three-point seat belts and 2 Isofix holders
- Double bed with level lying surface, approx. 190x131 cm
- Integrated wardrobe with ample storage space
- The removable seat cover also allows bulky holiday luggage such as snowboards, skis or surfboard can be transported comfortably





Comfort camping equipment.

The Reimo TravelStyle is the ideal family camper for 3 people. The sleeping/seating bench Variotech 3100 with 3 seats offers enough space for the whole family for a pleasant travel comfort and relaxed camping holiday.

The TravelStyle is equipped with a comfortable L-shaped kitchenette, a large cooker-sink combination with glass cover, as well as several drawers, a wardrobe and storage compartments. An integrated swivel shelf provides additional work space. The compressor refrigerator with freezer compartment provides ample space for your groceries.



Please ask your specialist dealer for further equipment and options. Equipment for the long wheelbase can be found At: www.reimo.com. Some of the illustrations show optional equipment that is not included in the scope of delivery.

REIMO TRAVELSTYLE - VW T6.1/T6/T5

Based on Volkswagen Transporter T6.1/T6/T5 station wagon, short wheelbase

Travel in style.

The 3-person bench seat with retractable headrests and 2 Isofix mounts for 2 child seats folds down into a comfortable double bed. Thanks to the removable front panel, long items such as surfboards and skis can be easily loaded under the bench seat. Size of the through-loading facility: LxWxH approx. 240x60x28 cm.

The integrated 45 litre compressor fridge (CRX50), the generous storage compartments and the prepared storage compartment for a mobile camping toilet (Porta Potti 335) and leave nothing to be desired on a family camping holiday



A clever detail of the equipment is the retractable shelf, which can be easily swung out of the kitchen block if required and offers additional work surface.

The integrated water system with 2x 12 Litre canisters supplies you with fresh drinking water during your holiday.

Technical specifications

TravelStyle short wheelbase:

Sleeping berths on sleeper/seat bench:	2
Bed dimensions Sleeper bench:	190 x 131 cm
Sleeping berths with optional sleeping roof:	4
Roof bed dimension:	200 x 120 cm
Sleeping/seating bench:	Variotech® 3000
Seats with three-point belts:	5
Cooker:	2-burner gas stove*
Refrigerator:	Compressor fridge* CRP 40 (approx. 43 l)
Gas capacity:	Space for 2x 5 kg gas bottle
Furniture:	Poplar plywood with HPL laminate
Fresh water / waste water:	2x 12 l / 16 l*
Tall cabinet:	117 x 126 x 33 cm
Hanging roof cupboard:	97 x 36 x 9 cm / approx. 32 l

Storage space:

- in the sliding door area:	2000 l
- under bed extension:	DxWxH 73x67x40 cm
- under the bench:	50x67x30 cm / 100 l

*Included in the technical package

Permissible total mass:

	3000 kg
Payload without sleeping roof :	approx. 640 kg
Payload with sleeping roof:	approx. 580 kg

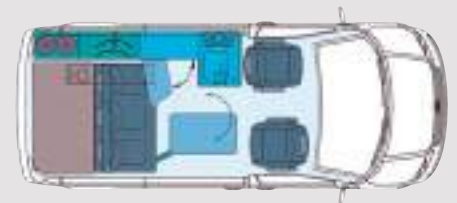

Daytime position

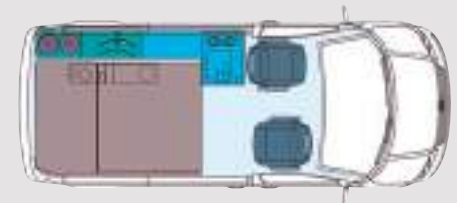

Night position



Fig. 1 shows furniture line with additional cupboard for long wheelbase.

For further equipment and options, please contact your specialist dealer
Equipment for the long wheelbase can be found at: www.reimo.com
Some of the illustrations show optional equipment that is not included in the scope of delivery.



Sleeping/seating bench Variotech® 3100 rigid: Three-seater, total width: 1205 mm, cushion width: 1150 mm, sleeping surface: 1900x1310 mm. 3 integrated, retractable headrests, 3 safety belts (size 10). For a maximum of 2 child seats (middle seat not usable when using a child seat). Fold-up rear upholstery (storage space height under rear upholstery: 46 cm), side panel. Fully upholstered incl. rear cushion Sleeper/seat bench not removable .Fabric design: Classic Grey, 2-colour.

5040600 3869,-

Mounting material for bench seat

Carrier 1	582081	32,95
Carrier 2	582082	34,05
Carrier 4	582084	291,50
Mounting kit	58208	89,90



Drawer

Provides additional storage space for e.g. shoes, cables or board tools. The drawer can be removed for loading long parts. Dimensions HxWxD: 17x49,5x69,5 cm. Decor: Basalt

5040690 549,-

Front panel

Installed on the bench instead of a drawer. The front panel is removable and therefore offers a through-loading possibility for e.g. surfboard or skis up to a length of max. 2,4m. (Loading dimensions under the bench HxW approx. 31x60 cm.) Decor: Basalt

5040680 259,-



Base plate 1-piece

made of waterproof chipboard with PVC covering. For original VW door sill. Decor: ship's bottom.

105251 379,-

X-Trem insulator, 15 mm thickness.

Extremely heat insulating and very light insulation. Is required under the floor slab. Supplied as panels of 2 x 1 m.

50009 22,99



Furniture line as finished part without technical package: (picture shows furniture line incl. technical package) With space for cooker and sink 600 x 455 mm, compressor fridge CRX50 approx. 45 ltr. (711236), Porta Potti 335 (660102). Equipment: Furniture unit with swivelling table, 2 small drawers and 2 larger storage compartments. Tall and linen cupboard with large cupboard compartment, sliding door, linen compartment and gas box for approx. 2x 5 kg gas bottle.cover/work top in laminate with real wood edges. Decor: walnut

Kitchen section	190921	1299,-
High and linen cupboard	190911	999,-



Technical package built into the above furniture unit:

Consisting of: Sink-cooker combination with glass cover, 2x 12 l fresh water canister, 1x 16 l waste water canister, water tap, submersible pump 18 l, compressor refrigerator CRX50 (45 l), gas system prepared for 2x 5 kg gas bottle, 12 V/230 V system with fuse panel 714, Automatic circuit breaker 13 A with Fi, 1x built-in socket 12 V, 1x built-in socket 230 V, Carbest switch-mode charger 15 A, 2 battery systems with Carbest AGM battery 80 Ah with holder is supplied for mounting under the driver's seat. CEE input socket is supplied for mounting in the side wall.

19100E 3059,-



Truma VarioHeat eco gas heater

Fitted in furniture unit, incl. chimney. The opening for the chimney as well as the chimney must still be attached to the vehicle.

720304E 2431,22



Table system with swivel table frame

mounting on the bench. Table top laminate wood decor slate, incl. fixing screws, approx. 75 x48 cm. Table edge in silver

18052 289,-



Hanging roof cupboard for EasyFit sleeping roof with slatted bed:

As a prefabricated part above rear bench seat for additional storage space. Cabinet pre-assembled. For short or long wheelbase with decor: walnut laminate

190932 399,-



Porta Potti 335 portable camping toilet

Suitable for TravelStyle furniture line .High quality plastic for maximum hygiene

660102 144,95

REIMO CITYVAN - VW T6.1/T6/T5

Based on Volkswagen Transporter T6.1/T6/T5 station wagon, short wheelbase

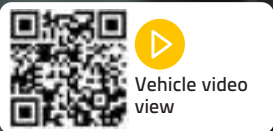

The true multifunctional mobile.

- Generous space concept with enormous luggage volume and load-through possibility up to 3.5 metres
- Super slim functional furniture line with integrated compressor cool box, Stainless steel sink with water system and prepared stove storage compartment
- Movable and tool-free removable 3-person bench seat, equipped as standard with 3 three-point seat belts and 2 Isofix mountings
- Large double bed (205x136 cm) with level lying surface
- Up to 7 luxurious seats with additional, retrofittable pilot seats
- Maximum flexibility due to variable living and storage space layout





All-round talent with loading volume.

Thanks to its multifunctionality, the CityVan combines everyday suitability and camping holidays in one vehicle.

Its generous space concept and its versatility open up almost unlimited possibilities for every situation.

The large free space in the vehicle offers plenty of room, even for pets and sports equipment.

With 5 to 7 comfortable seats, a slim functional furniture line, up to 4 sleeping berths (sleeping roof optional) and plenty of storage space, the CityVan is a leisure and everyday vehicle in one.

46 cm storage space height with the rear shelf folded down allows even large luggage to be stowed while the bench is converted into a bed.

The bench seat can be moved to directly behind the driver's cab seats, creating a mega boot volume of about 4800 litres.

Ideal, for example, for transporting bicycles for active holidays.

Please ask your specialist dealer for further equipment and options. Equipment for the long wheelbase can be found at: www.reimo.com. Some of the illustrations show optional equipment that is not included in the scope of delivery.



REIMO CITYVAN - VW T6.1/T6/T5

Based on Volkswagen Transporter T6.1/T6/T5 station wagon, short wheelbase

Travel. Leisure. Everyday life.

The CityVan embodies multifunctional driving fun and at the same time offers extensive, standard camping equipment for the best camping holidays and leisure trips.

The stainless steel sink (325x176 cm), a 13-litre fresh water canister and a 13-litre waste water canister are compactly integrated in the slim furniture unit

Several storage compartments offer storage space for further holiday utensils.



Even 1.5 litre bottles can be stored upright in the standard 26 litre compressor cooler. The top-loader design makes filling and removing the contents child's play. Since the cooler is integrated directly into the furniture line at handle height, cool drinks are always within reach, even when the bench is converted into a bed.

The CityVan offers a through-loading hatch up to 2.4 m in length with the bench seat panel removed or the bench seat drawer removed. Size of the through-loading hatch: WxH approx. 76x28 cm. Perfect for the transport of e.g. surfboard, ski or snowboards.



Please ask your specialist dealer for further equipment and options. Equipment for the long wheelbase can be found At: www.reimo.com. Some of the illustrations show optional equipment that is not included in the scope of delivery.

Technical specifications

CityVan short wheelbase:

Sleeping berths on sleeper/seat bench:	2
Sleeping berths with optional sleeping roof:	4
Clear bed dimension:	205 x 136 cm
Roof bed dimension:	200 x 120 cm
Sleeping/seating bench:	Variotech® 3000
Seats with three-point belts:	5
Refrigerator:	Compressor cooler (26 l)*
Furniture:	Poplar plywood with HPL laminate
Fresh water / waste water:	13 l / 13 l*
Overhead locker:	123 x 27 x 11 cm / approx. 36 l rear storage space:
- with / without bench seat:	2700 l / 4500 l
- under bed extension:	DxWxH 63x120x40 cm
- under bench:	90 x 63 x 31 cm / 175 l

*Optional

Permissible total mass:	3000 kg
Payload without sleeping roof:	720 kg
Payload with sleeping roof:	660 kg

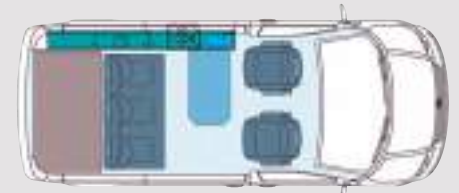

Daytime position



Night position





Sleeping/seating bench Variotech® 3000
 three-seater, size 14, total width: 1305 mm.
 Upholstery width: 1250 mm, sleeping area:
 2000x1360 mm. 3 integrated, retractable head-
 rests, 3 seat belts, Isofix attachment points for a
 maximum of 2 child seats (middle seat cannot
 be used when a child seat is used), fold-up rear
 upholstery (storage space height under rear uphol-
 stery: 46 cm), side panel. Fully upholstered incl.
 rear cushion. Sliding and removable bench. Rail
 spacing 826 mm.
 Fabric design: Classic Grey, 2-coloured.

5040100 4359,-

Slide rail set "Grizzly" KR

For Variotech® 3000

58200 426,59

Including fastening set For slide rail set "Griz-
 zly" for short wheelbase. For fastening the slide
 rails to the vehicle floor. Rail spacing 826 mm.

58203 240,90



Drawer

Provides additional storage space for e.g. shoes,
 cables or board tools. The drawer can be removed
 for loading long parts. Dimensions HxWxD: approx.
 17x66,5x69,5 cm. Decor: Basalt

5040190 679,-

Front panel

Installed on the bench instead of a drawer. The
 front panel is removable and therefore offers a
 through-loading option for e.g. surfboard or skis
 up to a maximum length of 2.4m. (Loading di-
 mensions under the bench

HxW approx. 31x75 cm. Decor: Basalt

5040180 239,-



Base plate 3-piece, rail spacing 826 mm.
 made of waterproof chipboard with PVC covering.
 For original VW door sill. Décor: ship's floor

1053832 425,-

X-Trem insulator, 18 mm thickness

Extremely heat insulating and very light insula-
 tion. Is needed under the floor plate 2xfor KR.
 Supplied as panels with a 2 x 1 m.

50009 22,99



**Furniture unit as finished part without tech-
 nology package** Elegant furniture part with cover
 flaps. Prepared for installation of water system,
 compact sink and cool box. Standard decor: an-
 thracite metallic.

10794 2789,-



**Technical package built into the
 above furniture line**

Water system with sink, water tap, 2x 13 l fresh
 and waste water canisters, submersible pump.
 With additional fuse panel 714. Slim 26 litre
 Reimo compressor cooler with plenty of space and
 only 200 mm depth. Temperature range from +1°
 C to 10° C. External cooling unit, Danfoss BD 2.5
 compressor. Dimensions: approx. W 570 x D 200
 x H 360 mm. Weight approx. 18.9 kg, built-in.

60004E 389,-

With additional fuse panel 713

60004EE 495,-

Compressor cooler 20L built into furniture unit
71177E 1319,-



Diesel heater Breeze

Small, compact heater for mounting under the
 passenger seat. Power: 2,7 KW, fuel consumption
 max. 0,33 l/h. Power consumption: 74-130 W.
 Dimensions: L 355 x W 124 x H 126 mm

48129 699,-

Digital control panel **48130 139,90**

Manual control panel **48131 109,90**

Mounting bracket under passenger seat
48132 99,90

Fuel tank extraction set 707191 107,50



Table system with swivel table frame

With wall bracket and folding table base. Table
 top in laminate decor slate, approx. 85 x 47 cm.
 Table edge: high gloss anthracite-silver.

50158 255,-



**Hanging roof cupboard for EasyFit sleeping
 roof with slatted bed:** As a prefabricated part
 above rear bench seat for additional storage
 space. Cabinet pre-assembled. For short or long
 wheelbase with decor: high-gloss anthracite-silver

10820L 599,-



PortaPotti kit

For mounting the Porta Potti toilet. When the kit is
 fitted, the bench cannot be pushed all the way
 forward. (Without Porta Potti toilet)
 Decor: High gloss anthracite-silver

10799 475,07

Porta Potti 335 portable camping toilet

Suitable for Porta Potti kit .High quality plastic for
 maximum hygiene

660102 144,95

REIMO WEEKENDER PLUS - VW T6.1/T6/T5

Based on Volkswagen T6.1/T6/T5 estate, short wheelbase



Family van with XXL double bed

- Large bed with level sleeping surface over the entire interior width of the vehicle (approx. 200x155 cm), without disturbing seams or belts
- Sliding 3-person bench seat, equipped as standard with 3 three-point belts and 2 Isofix holders
- Compact kitchen block with sink and water system, prepared for optionally available gas cartridge cooker
- Including storage box with 12V socket for optional cool box
- Up to 7 luxurious seats with additional, retrofittable pilot seats





XXL sleeping pleasure on the road.

The Reimo Weekender Plus is the all-rounder for everyday life, work and leisure. The heart of this camper is the XXL bed with a generous lying surface of approx. 200x155 cm. The flat sleeping surface extends over the entire interior width of the vehicle.

Next to the huge bed is a slim kitchen module with sink and water unit. Perfect for weekend trips and short holidays.

Side storage boxes offer enough space for small travel accessories and an optional cool box.

The Variotech® 3000 comfort bench seat can be easily moved, allowing the living and stowage space to be flexibly arranged.

The Weekender offers up to 7 seats thanks to the retrofittable optional individual seats (for vehicles with glued-in floor rails).

Please ask your specialist dealer for further equipment and options. Equipment for the long wheelbase can be found at: www.reimo.com. Some of the illustrations show optional equipment that is not included in the scope of delivery.



REIMO WEEKENDER PLUS - VW T6.1/T6/T5

Based on Volkswagen T6.1/T6/T5 estate, short wheelbase

Family van for leisure & everyday life.

The Weekender Plus contains a compact kitchen unit with integrated sink and water system and water system. The swivelling kitchen block cover can be turned into an additional storage area additional storage space

A large side storage box offers enough space for everything that needs to be there

The upholstered surface of the storage box not only creates a homely ambience in the vehicle, but also widens the sleeping area to the entire width of the vehicle.

Technical specifications

Weekender Plus short wheelbase

Sleeping berths on sleeper/seat bench:	2
Sleeping berths with optional sleeping roof :	4
Clear bed dimensions with storage box:	205 x 160 cm
Sleeping/seating bench:	Variotech® 3000
Seats with three-point belts:	5
Cooling unit (option):	Compressor cooler Dometic CF 26 (21.5 l)
Furniture making:	Poplar plywood with HPL laminate
Overhead locker:	97 x 36 x 9 cm / approx. 32 l
Rear storage space:	
- with / without bench seat:	2800 l / 4700 l
- under bed extension:	DxWxH 63x120x40 cm
- under bench:	43 x 75 x 28 cm / 90 l

Permissible total mass:	3000 kg
Payload without sleeping roof:	approx. 640 kg
Payload with sleeping roof:	approx. 580 kg

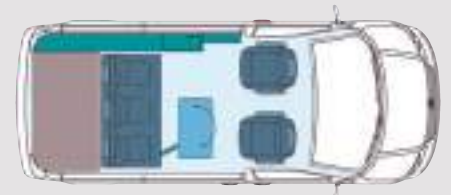

Daytime position

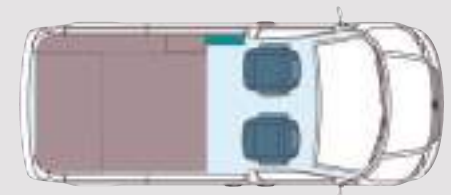

Night position



Next to the kitchen module, a compressor cooler (CF2G) with 21.5 litres of useful capacity is located under an upholstered pad. A removable basket insert facilitates the removal of food and can be easily removed for easy cleaning of the cooler.



As optional equipment you get a bench drawer. It offers storage space for e.g. shoes, cables or sleeping bags as well as other holiday luggage.

The drawer can be removed for loading long items.

This creates a loading hatch in the Size WxHxD: 66,5x17x69,5 cm.

For further equipment and options, please contact your specialist dealer. Equipment for the long wheelbase can be found at: www.reimo.com. Some of the illustrations show optional equipment that is not included in the scope of delivery.

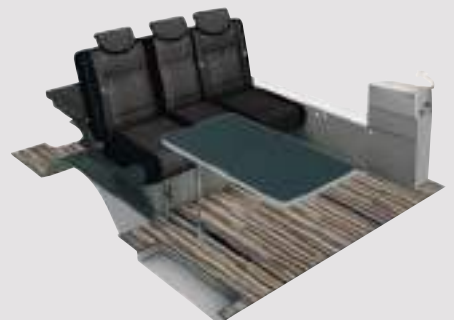



Sleeping/seating bench Variotech® 3000
 three-seater, size 14, total width: 1305 mm. Upholstery width: 1250 mm, sleeping area: 2000x1600 mm. 3 integrated, retractable headrests, 3 safety belts, Isofix attachment points for a maximum of 2 child seats (middle seat cannot be used when a child seat is used), fold-up rear upholstery (storage space height under rear upholstery: 46 cm), side panel. Fully upholstered incl. rear cushion. Sliding and removable bench. Rail spacing 826 mm.
 Fabric design: Classic Grey, 2-tone

5040200 4365,90

"Grizzly" slide rail set For Variotech® 3000 kR
58200 426,59

Fastening set

For slide rail set "Grizzly" for short wheelbase. For fastening the slide rails to the vehicle floor. Rail spacing 651 mm.

58203 239,-



Drawer

Provides additional storage space for e.g. shoes, cables or board tools. The drawer can be removed for loading long parts. Dimensions HxWxD: approx. 17x66,5x69,5 cm. Decor: Basalt

5040290 669,-

Front panel

Installed on the bench instead of a drawer. The front panel is removable and therefore offers a through-loading possibility for e.g. surfboard or skis up to a length of max. 2,4m. (Loading dimensions under the bench HxW approx. 31x75 cm), Decor: Basalt

5040280 249,-



Base plate 3-pcs

made of waterproof chipboard with PVC covering. For original VW door sill. Decor: ship's foolr

1053832 425,-

X-Trem insulator, 18 mm thickness

Extremely heat insulating and very light insulation. Is needed under the floor plate 2x for kR. Supplied as panels with a 2 x 1 m.

50009 22,99



Kitchen module including Equipment

Compact kitchen block and side storage box in HPL laminate anthracite silver. The storage box is inaccessible from the interior and from the rear. The upholstered surface enlarges the bed in the sleeping position to full vehicle width. Mini sink, pull-out, 1x 13 l fresh water canister, 1 x 13 l waste water canister. With 21.5 l compressor cooler. Including necessary installation accessories

① Kitchen module 10689 1375,-

② Storage box kR 10696 839,-



Diesel heater Breeze Small, compact heater for mounting under the passenger seat. Power: 2,7 KW, fuel consumption max. 0,33 l/h. Power consumption: 74-130 W. Dimensions: L 355 x W 124 x H 126 mm

48129 699,-

Digital control panel **48130 139,90**

Manual control panel **48131 109,90**

Mounting bracket under passenger seat **48132 99,90**

Fuel tank extraction set 707191 107,50



Table system with swivel table frame

is attached to the bench. Table top laminate wood decor slate, incl. fixing screws, approx. 75 x48 cm. Table edge: anthracite silver.

18052 289,-



Hanging roof cupboard for EasyFit sleeping roof with slatted bed

As a prefabricated part above rear bench seat for additional storage space. Cupboard pre-assembled. For short or long wheelbase with decor: anthracite silver.

10820L 599,-



Porta-Potti Box

in HPL laminate with upholstery. (Without Porta Potti toilet) Décor: Anthracite Silver

10696 839,-



Porta Potti 335 portable camping toilet

Suitable for Porta Potti kit. High quality plastic for maximum hygiene

660102 144,95

REIMO WEEKENDER - VW T6.1/T6/T5

Based on Volkswagen Transporter T6.1/T6/T5 station wagon, short wheelbase

Large capacity van for up to 7 people.

- Sliding and tool-free removable 3-person bench seat, equipped as standard with 3 three-point belts and 2 Isofix mountings
- Large, flat lying area of approx. 205 x 150 cm across the entire width of the vehicle
- A choice of various kitchen modules and CampingBoxes is available as a supplement



Whether for business, everyday life or leisure - the Reimo Weekender is the perfect first vehicle for every occasion

The all-round talent Weekender is in everyday life and work a large capacity sedan with plenty of freedom of movement for 5-7 passengers (all seats with three-point belts) and ample storage space in the rear

In leisure time it becomes with the optional kitchen block the perfect travel companion with 2 - 4 full sleeping berths. (Sleeping roof optional)

Whether with one or two sliding doors, with or without kitchen block, elegantly equipped on Caravelle Comfortline basis or purely functional and robust on Transporter Kombi basis - the choice is yours.

Weekender Swing kitchens

- Swivelling and removable kitchen section for installation behind the driver's cab seats
- Safe installation in the vehicle in the Reimo floor rails
- Stainless steel sink and water system with 12 litre fresh water and 12 litre waste water canisters
- Can be swivelled outwards with the optional swivel bracket (available for left or right side of vehicle)
- The kitchen module can also be completely removed from the vehicle, ideal for cooking in the awning
- Convenient cooking outside the vehicle
- No odour nuisance in the interior
- Plenty of storage space, large drawer
- 2 handles for easy lifting
- The kitchen block can be left at home for everyday use (with car registration)



You will find suitable kitchen modules on the following pages.

Please ask your specialist dealer for further equipment and options. Equipment for the long wheelbase can be found At: www.reimo.com. Some of the illustrations show optional equipment that is not included in the scope of delivery.

Technical specifications

Weekender short wheelbase:

Sleeps on sleeper/seat bench:	2
Sleeping berths with optional sleeping roof:	4
Clear bed dimensions with storage box:	205 x 160 cm
Sleeping/seating bench:	Variotech® 3000
Seats with three-point belts:	5
Rear storage space	
- with / without bench seat:	3100 l / 5100 l
- under bed extension:	DxWxH 63x122x40 cm
- under bench:	43 x 75 x 28 cm / 90 l



Daytime position



Night position

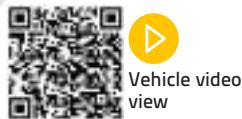

Vehicle video view



Sleeping/seating bench Variotech® 3000

For vehicles without side plastic panelling. Three-seater, size 17, total benchwidth: 1380 mm. Upholstery width: 1330 mm, sleeping area: approx. 2000x1600 mm. 3 integrated, retractable headrests, safety belts. Isofix attachment points for max. 2 child seats (middle seat cannot be used when a child seat is used), fold-up rear upholstery (storage space height under rear upholstery: 46 cm), front trim and side trim. Fully upholstered incl. rear cushion. Sliding and removable bench. Rail spacing 997 mm. Fabric design: Classic Grey, 2-coloured.

5040300 4359,-

"Grizzly" slide rail set For Variotech® 3000 kR

58200 426,59

Fastening set

For "Grizzly" sliderail set for short wheelbase. For fastening the slide rails to the vehicle floor. Rail spacing 997 mm.

58202 219,-



Drawer

Provides additional storage space for e.g. shoes, cables or board tools. The drawer can be removed for loading long parts. Dimensions HxWxD: approx. 17x83,5x69,5 cm. Décor: Basalt

5040390 679,-

Front panel

Installed on the bench instead of a drawer. The front panel is removable and therefore offers a loading possibility for e.g. surfboard or skis up to a length of max. 2,4m. (Loading dimensions under the bench

HxW approx. 31x80 cm. Decor: Basalt

5040380 249,-



Base plate 3-pcs

made of waterproof chipboard with PVC covering. For original VW entrance rail. Rail distance 997 mm. Décor: ship's bottom

1053842 423,32

X-Trem insulator, 18 mm thickness

Extremely heat insulating and very light insulation. Is needed under the floor panel 2xfr kR. Supplied as panels with a 2 x 1 m.

50009 22,99



Table system with swivel table frame With wall bracket and folding table base. Table top in laminate decor slate, approx. 85 x 47 cm. Table edge in silver.

18052 289,-



Hanging roof cupboard for EasyFit sleeping roof with slatted bed As a prefabricated part above rear bench seat for additional storage space. Cabinet pre-assembled. For short or long wheelbase with decor: Anthracite Metallic.

10820L 599,-

 Please ask your dealer for further equipment and options

MULTIFUNCTIONAL KITCHEN COMPONENTS



Kitchen parts for Weekender/Multivan



Anthracite



(Stove not included) Black

White



Plenty of storage space. Large drawer. (Pot and stove not included)

Sink with Faucet

Back cover

With these functional kitchen parts you can quickly and easily transform your Reimo Weekender or VW Multivan into a practical and comfortable camper

With complete basic camping equipment. 2x12 litre canisters for fresh water and waste water are located in the rear part of the kitchen section and are concealed by the backrest of the cab seat. Each kitchen section is equipped with a drawer and a spacious storage compartment

Provided for a built-in sink with integrated glass cover (70135). A folding table can be fitted either on the right or left, so the kitchen sections can be used on the driver's or passenger's side. Stylish furniture construction with distinctive rounded aluminium edges at the front.

Fastening in the seat mounting rails. The kitchen section fits exactly between the front edge of the bench seat (which has been converted into a bed) and the front seats. Dimensions: H73 x W65 x D48,5 cm.

With sink, glass cover and technology. Installed ready for connection with 12 V plug. (Weight approx. 35 kg)

Furniture decor:

Anthracite Metallic	11100T	1272,-
High gloss silver	11100TS	1318,-
High glosswhite	11100TW	1318,-
High glossblack	11100TB	1318,-

Kitchen part "France" for VW California Beach



- Professional "mini kitchen" for your California Beach
- 2-burner gas cooker
- Space for 2.8 kg gas bottle in elegant cooker cabinet

Compact, 2-burner gas cooker. Adds a cooking facility to your California Beach. The cooker cabinet blends harmoniously into the vehicle's appearance. The gas box is located in the lower part of the 'mini-kitchen'. This offers space for a 2.8 kg Campingaz bottle. The necessary and prescribed drop gas opening is led through the vehicle floor (40 mm). Additional storage compartment above the gas bottle

Kitchen section with cooker, glass cover and technology. Installed ready for connection and prepared for installation in the vehicle. Dimensions: H737 x W510 x D390 mm.

Furniture decor:

Anthracite Metallic	11103T	1425,-
High gloss white	11103TW	1468,-
High glossblack	11103TB	1468,-
High glosssilver	11103TS	1468,-

Kitchen part Calicook for VW California Beach you will find on page 24

Info: Installation of the floor rails should be carried out in a trained specialist workshop. Not for do-it-yourself installation. Installation of floor rails in empty vehicle without fastening points: Time required approx. 4 hrs. (additional time for all-wheel drive plus approx. 4 hours). Vehicles with original seat benches: plus approx. 30 min additional expenditure per original attachment point

MULTIFUNCTIONAL KITCHEN PART "EASY-KITCHEN"

For Volkswagen T6.1/T6/T5 station wagon, kR or IR and Mercedes Vito long station wagon

- Removable kitchen section for installation behind the driver's or passenger seat
- Can be swung out with optional swivel fitting
- With stainless steel sink and water system
- Convenient cooking outside the vehicle
- No odour nuisance in the interior
- Plenty of storage space, large drawer
- The kitchen block can stay at home in everyday use.



Equipment:

- ① Stainless steel sink
- ② Pull-out tap with shower hose
- ③ Water system with submersible pump (connection to 12 V socket) and a 10 litre fresh water and waste water canister each
- ④ 1 drawer for cutlery and crockery
- ⑤ 1 storage compartment for pots and dishes
- ⑥ Storage compartment for gas cartridge stove
- ⑦ 2 side folding tables 388 x 295 mm
- ⑧ 2 handles for easier lifting

Kitchen section pre-assembled with built-in technology, including fastening material for Reimo floor rails.

Kitchen part for installation on the right/left behind driver's cab seats in VW T5/T6 Kombi/Caravelle in connection with a Reimo sleeping bench V3000 (not suitable for Multivan and California Beach).

For installation behind the passenger seat in the Mercedes Vito. In combination with a Reimo sleeping bench V3000 the full bed length can be used.

Overall dimensions: W 595 mm (tables folded down), H 730 mm x D 450 mm (plus canister 76 mm)

Furniture decor: high gloss white

for mounting on the right **11112 1685,-**
for assembly left **11113 1789,-**

High gloss silver

for mounting right **11112S 1789,-**
for mounting left **11113S 1789,-**

Matt black

for mounting right **11112B 1889,-**
for mounting left **11113B 1889,-**

⑨ Suitable swivel unit

(for installation on the B-pillar with suitable tools)

for VW mounting right **11114 499,-**
for VW mounting left **11115 499,-**

for Mercedes Vito (only possible with Easy)

57112 499,-

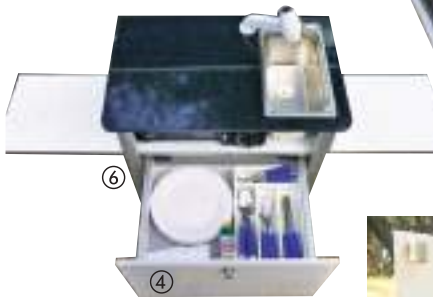

Kitchen accessories and cookers shown on this page are not included.

REIMO BIKE`N'SURF - VW T6.1/T6/T5

Based on Volkswagen Transporter T6.1/T6/T5 station wagon, short wheelbase

Comfort bed at a top price

- Camping bus equipment with huge storage space
- Easy installation in the vehicle due to bolting to existing points
- Comfortable maxi bed with a lying surface of 198 x 130 cm
- Comfortable upholstery with slatted frame and 11 cm thick mattress
- Huge storage space due to adjustable bed height



Sleep, stow, live:

The comfortable bed with a lush cold foam mattress and a lying surface of 198 x 130 cm is adjustable in height, so that a huge storage space of 55 to 80 cm in height is available underneath in full interior width. Good for luggage!

The original bench seat in the 2nd row can remain installed and is simply folded down to make a bed. This gives you 4 seats for the journey and a comfortable bench seat for living



High quality
Cover fabric



Sporty loading:

If you like to stow your bike or other bulky sports equipment inside the vehicle, use the space next to the bed for this.

Cook and enjoy fresh food:

In addition to a cupboard element, an optional Cooky kitchen module with 4 practical functions:

Removable compressor cooler with 18 litre capacity, pull-out for gas cartridge stove, drawer for crockery, cutlery and utensils and a table (usable in 2 heights) perfect for outdoor breakfast or washing up. Another sliding table is located in the living area inside.

All extension modules are inserted and removed just as quickly in a few simple steps, without tools or modifications to the vehicle.

For further equipment and options, please contact your specialist dealer. Equipment for the long wheelbase can be found at: www.reimo.com. Some of the illustrations show optional equipment that is not included in the scope of delivery.

Technical specifications

Bike'N'Surf short wheelbase:

Sleeps on bed construction :	2
Sleeping berths with optional sleeping roof:	4
Light bed dimensions:	198x130 cm
Seats with three-point seat belts :	2
Cooker:	1-burner gas stove*
Refrigerator: Coolfreeze CDF 18 compressor cooler*	
Gas capacity :	Space for 2x 5 kg gas bottle
Furniture:	Poplar plywood with HPL laminate
Fresh water / waste water:	1x 12 l / 12 l*
Tall cabinet:	WxHxD approx. 100x131x39 cm
Storage space under the bed:	
Bed height 1: 510 mm loading height	
Bed height 2: 570 mm loading height	
Bed height 3: 670 mm loading height	

*Included in the optional technical package

Permissible total mass:	3000 kg
Payload without sleeping roof :	approx. 640 kg
Payload with sleeping roof:	approx. 580 kg



Daytime position



Night position



Bike'N'Surf (kit)

Bed construction height adjustable: 1. bed height 710 mm / loading height 510 mm 2. bed height 770 mm / loading height 570 mm 3. bed height 810 mm / loading height 670 mm Slatted frame extendable (198 x 130 cm) complete incl. comfort upholstery with 11 cm thick mattress. Sleeping surface: 122/160x192 cm. Incl. fixing material.

Info In VW T6/T5 Multivan, Caravelle and High-line the installation of the bed is unfortunately not possible.

11004 **1049,-**



Kitchen module "Cooky"

prefabricated part without technology, prepared for optional Dometic cool box CDF18. Granitto decor (not available for long wheelbase)

11006 **939,-**



Cabinet suitable for VW T5/T6 KR box and estate without second heat exchanger

for use at the side of the bed. 1 compartment with hinged flap and adjustable shelf and 1 compartment with removable lid. approx. W 1000 x H 1312 x D 390 mm decor Granitto.

110082 **969,-**



Table system (kit) in Granitto decor

11009 **259,-**



Curtains grey, translucent, including curtain rail and glider Short wheelbase

19231 **199,-**

Cab

19240 **119,-**



Optional compressor cooler 18 litres
Dometic CDF18 12/24 V

711490 **599,-**

REIMO FLORIDA KIT - VW T3

Based on Volkswagen Transporter T3, modelyear 1980 to 1990



The classic

- Florida kit for self-assembly
- Timeless and proven furnishing concept



Picture examples, decors and upholstery may vary.
The technology shown is not included in the scope of delivery. Push locks are optional extras.

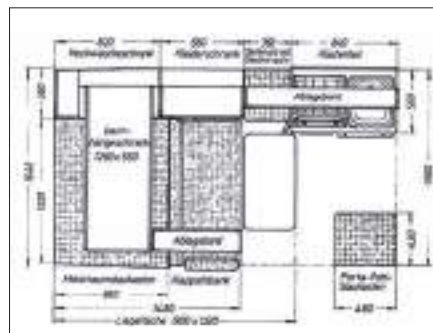
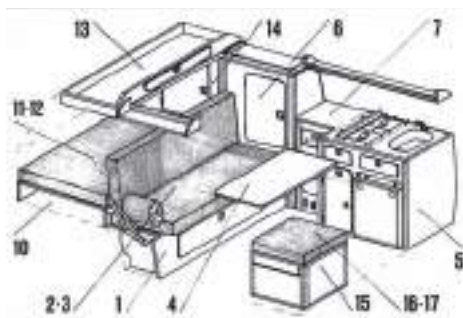

Simply retrofit your historic vehicle to ORIGINAL Reimo Florida or add original parts to the interior Decor Granitto laminate. The wooden panels, doors, etc. are ready-cut, you only need to assemble them.

Lipping, hinges and furniture handles must be fitted

- Floor panel Ship 10520 239,-
- 1 Upholstered folding bench, narrow at the back 13201015 425,-
- 2 Foam for folding bench seat 13201120 149,-
- 3 Classic grey covers for narrow 13201227 289,-
- 4 Swivel table, large and practical 13202015 189,-

- 5 Kitchen section, wide, with drawer and Gas bottle compartment, for compressor-Refrigerator CRX 65/711237 suitable (For 60-l-absorber-refrigerator 71351 adaptable) 13203015 529,-
Kitchen part with door, if no refrigerator is to be installed 13203115 589,-
- 6 Wardrobe, lateral with clothes rail 13204015 294,-
- 7 Crockery cupboard, 1-door, with space for Reimo display panel 251 and heater 1800 13211215 242,-
- 10 Full-width engine compartment box (height 13 cm), Removable rear centre section 13207015 295,-
- 11 Foam (Mopo narrow for engine compartment) 13210020 119,-
- 12 Cover for Mopo (s) 13210127 265,-
- 13 Hanging roof cupboard with 1 fixing plate 13208115 325,-

Vehicle dimensions

- Seating capacity 4
- Length 475 cm / width 185 cm
- Height with HOD 262 cm / SD 220 cm
- Living room height HOD 185 - 205 cm
- Living area height SD 218 - 236 cm
- Weight Empty 1900 kg / Total 2390 kg
- Bed dimensions below 190 x 125 cm
- above HOD 210 x 120 / SD 185 x 112 cm
- Refrigerator 43 l or 60 l*
- Heating E2400*
- Gas bottles 2x 5 kg*
- Fresh water 60 l / waste water 60 l*
- * Optional

- 14 Linen cupboard in the rear, with shelf 13205015 309,-
- 15 Porta-Potti storage box in special design (suitable for Porta-Potti 145/345) 13206015 239,-
- 16 Foam for Porta-Potti storage box 13206120 37,90
- 17 Cover for PP storage box 13206226 89,95
- Side seat for electronic heating or storagebox 13208015 149,-
- Foam for side seat Florida 80 13208120 55,-
- Cover for side seat 13208226 99,95
- Storage board Driver's side 13212815 149,-

Recommended accessories:

- 60-l-absorber refrigerator RM 5310, 30 mbar 71351 1051,-
- 57-l-compressor refrigerator, 12 V/24 V CRX 65, including 7 l ice compartment 711237 1139,-

REIMO SPEEDY KIT - VW T3

Based on Volkswagen Transporter T3, modelyear 1980 to 1990

The Speedy kit with Granitto surface. Robust and proven.

- Kit for self-assembly
- Great price-performance ratio
- Timeless and functional
- Shapely edges and furniture handles

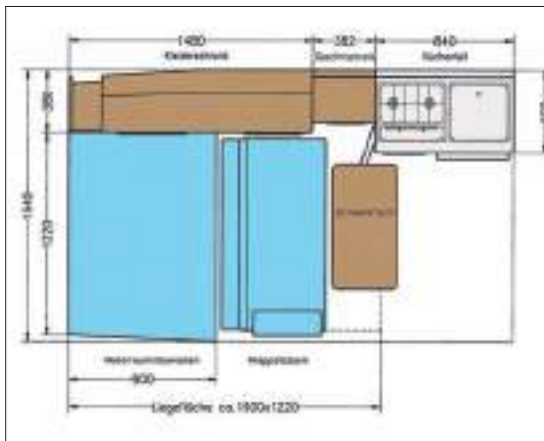

Devices are **not** included in the scope of delivery

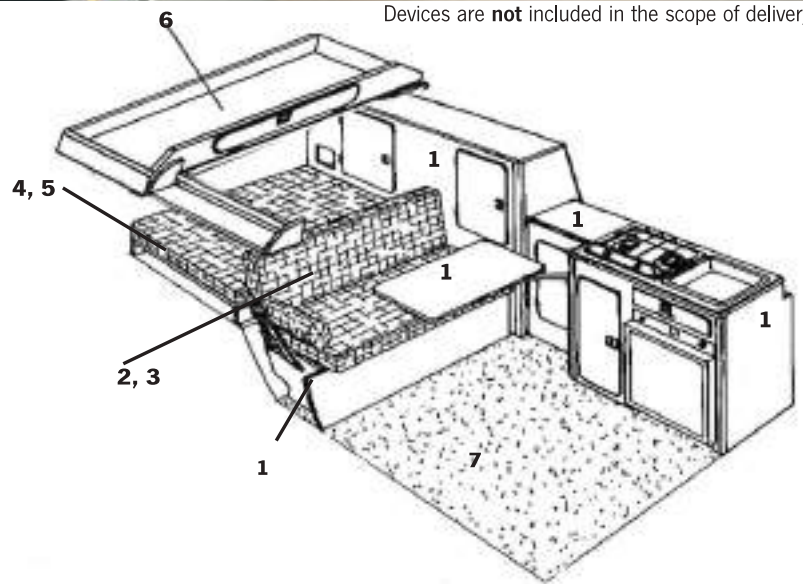

- 1 Speedy kit** Consists of table unit, folding bench seat (without flap in front panel), wardrobe combined with rear linencupboard. Kitchen section with drawer, gas bottle compartment, upper cover plate (without cut-out; installation of cooker and sink possible) and cut-out for installation of refrigerator. Crockery cupboard to left of kitchen section, 1-door, engine compartment storage cupboard. Granitto laminate, lipping, hinges as well as furniture handles have to be mounted. (Folding bench without foam and covers) **13001 1499,-**
- 2 Foam for bench** **13201120 149,-**
- 3 Cover Classic bench**, grey, laminated, 3 mm (100% polyester) **13201227 289,-**

- 4 Foam for engine compartment**
13210020 119,-
- 5 Cover Classic engine compartment**, grey, laminated, 3 mm (100% polyester)
13210127 265,-
- 6 Overhead cabinet with flap, kit**
13208115 325,-
- 7 Floor panel**
Ship's floor **10520 239,-**



Granitto - T3/T4/T5/T6 Poplar plywood with 0.6 mm HPL coating, on both sides



Standard fabric Classic Grey 100% Polyester, 3 mm foam laminated

Tip: With our technology sets water system, 12 V/220 V system, gas system your Speedy equipment becomes complete. See accessories catalogue

REIMO JOLLY KIT - VW T3

Based on Volkswagen Transporter T3, modelyear 1980 to 1989



Low-priced camper kit for individual design.



- Camper kit for easy self-assembly
- Made of natural wood for an individual surface design
- Material: Natural multi-layer poplar plywood
- The floor plan is similar to the Florida 80-/Speedy furnishing which has been tried and tested for many years

1 Jolly kit including table system and folding bench Complete kit for self-assembly. The wooden boards, doors etc. are ready-cut, you only need to assemble them. Hinges and furniture handles have to be mounted. Show individuality with staining, glazing or varnishing. Of course, a bio-finish is also possible. Untreated kit. (without foam, without cover)

130000 1199,-

2 Foam for folding bench

13201120 149,-

3 Cover for folding bench, Classic grey design, unquilted (100% polyester)

13201227 289,-

4 Foam for engine compartment

13210020 119,-

5 Cover Classic engine compartment, grey, laminated, 3 mm (100% polyester)

13210127 265,-

6 Overhead locker

130001 199,-

7 Base plate

Ship's floor 10520 239,-

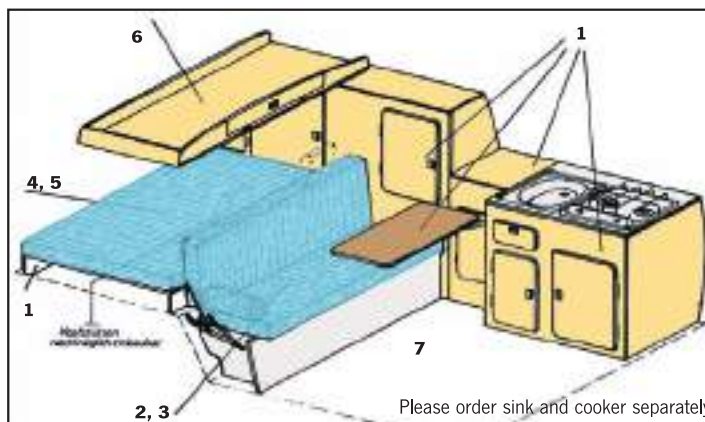
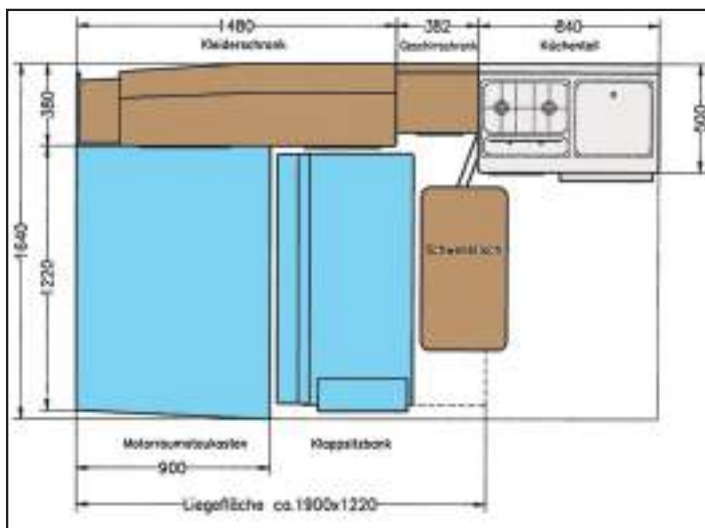

Pickling examples

With Reimo
all over the world
at home.
Since 1980.

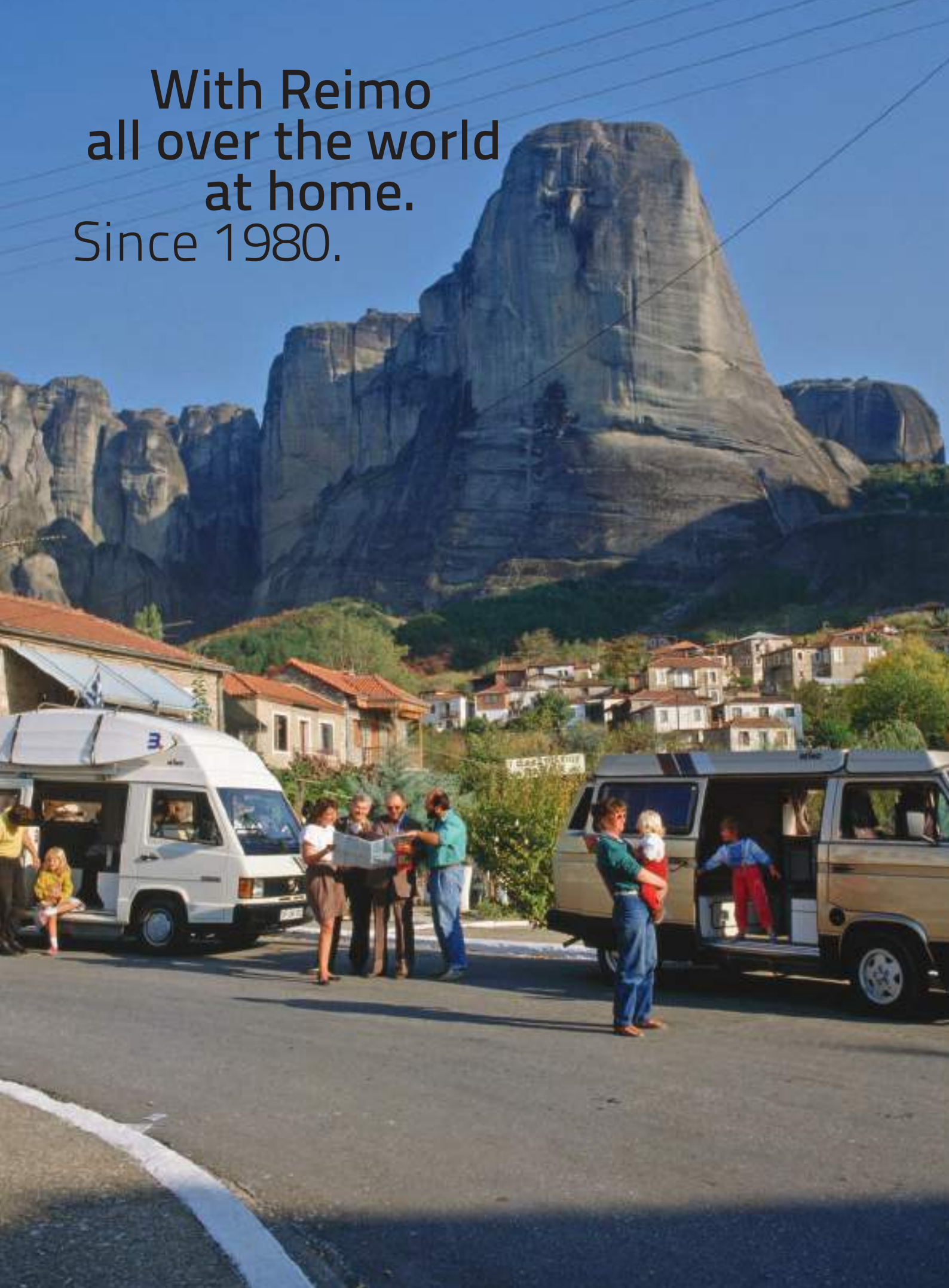

– CONTENTS –

REIMO TRIOSTYLE FOR MERCEDES-BENZ VITO	82-83
REIMO CITYVAN FOR MERCEDES-BENZ VITO	84-85
REIMO WEEKENDER FOR MERCEDES-BENZ VITO.....	86-87





REIMO VAN-CONCEPT

MERCEDES-BENZ VITO

Exclusive camping extensions with multifunctional living and room concepts for Mercedes Benz Vito.

Whether a slim line of furniture or a fully equipped camping bus
For the individual leisure activity - the right conversion concept.

REIMO TRIOSTYLE - MERCEDES BENZ VITO

Based on Mercedes Benz Vito long station wagon (overall length 514 cm) from 8/2014

Five stars on wheels.

- Exclusive camping full equipment
- 5 three-point seat belts allow driving with 5 people (up to 7 people with optional single seats)
- Plenty of storage space in the rear as well as under the bench seat
- Sliding and easily removable bench seat
- Swivelling working/dining table
- Easily accessible water/waste water canisters in the rear



A clever extension highlight is the storage compartment flap, which is integrated into the underside of the bed.

It allows quick access to travel utensils and luggage in the boot from the vehicle interior, when the bench seat is converted into a sleeping bench.

This means you don't necessarily have to leave the vehicle, which is particularly practical in bad

Please ask your dealer for further equipment and options. Some of the illustrations show optional equipment that is not included in the scope of delivery.

Technical specifications

Sleeps on sleeping/seating bench: 2
 Sleeping berths with optional sleeping roof: 4
 Light bed dimensions: 198x132 cm
 Sleeping/seating bench: Variotech® 3000
 Seats with three-point seat belts: 5
 Cooker: 2-burner gas stove*
 Refrigerator: Compressor fridge (39 l)*
 Gas capacity: Space for 2x 5 kg gas bottle
 Furniture: Poplar plywood with HPL
 Laminate and postforming edges
 Fresh water / waste water: 2x 12 / 27 litres*
 Wardrobe: approx. 57 x 24 x 82 cm / approx.112 litres

Tall unit: 117 x 126 x 33 cm
 Overhead cupboard: 97 x36 x9 cm / approx. 32 l
 Rear storage space:
 - with / without bench seat: 2700 l / 4100 l
 - under bed extension: DxWxH 63x112x37 cm
 - under bench: 65 x 55 x 26 cm / 93 l

*Included in the technical package

Payload example:

Mercedes Vito long "Tourer Base" base vehicle

Permissible total mass: 3050 kg

Payload without sleeping roof: approx. 840 kg

Payload with sleeping roof: approx. 770 kg



Daytime position

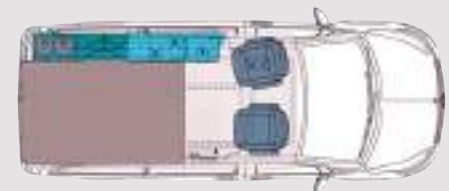

Night position





Sleeping/seating bench Variotech® 3000

Three-seater, size 8 Total width: 1155 mm, cushion width: 1100 mm, sleeping area: 1980x1320 mm. 3 integrated, retractable headrests, 3 safety belts, Isofix attachment points for a maximum of 2 child seats (middle seat cannot be used when a child seat is used), fold-up rear upholstery (storage space height under rear upholstery: 42 cm, storage space height under bench seat: 31 cm), with side panel. Fully upholstered incl. rear cushion. Sliding and removable bench. Rail spacing 700 mm. Fabric design: Classic Grey, 2-coloured.

5045000 4359,-

"Grizzly" slide rail set

2 aluminium slide rails, silver anodised for Vito long.

Length: 286 cm, 4 different driving positions.

58326 508,-

Steel floor adapter

Required for installation of slide rail.

Right type 1 **58327 240,90**

Middle type 2 **583271 290,40**

Fastening set

For fastening the slide rails to the vehicle floor. Rail spacing 700 mm (Vito long).

58328 339,90



Drawer optionally available

Provides additional storage space for e.g. shoes, cables or board tools. The drawer can be removed for loading long parts. Dimensions HxWxD: approx. 17x49,5x69,5 cm. Décor: Basalt

5045090 639,-

Front panel optionally available

Installed on the bench instead of a drawer. The front panel is removable and therefore offers a through-loading possibility for e.g. surfboard or skis up to a length of max. 2,4 m.

(Loading dimensions under the bench HxW approx. 31x60 cm). Décor: Basalt

5045080 249,-



Base plate 3-pcs

made of waterproof chipboard with PVC covering. For MB Vito (long). Rail spacing 700mm Décor: ship's floor

16807 435,-

X-Trem Insulator, 15 mm thickness

Extremely heat insulating and very light insulation. Is required under the floor slab. Supplied as panels with a 2 x 1 m. (3x for kR)

50009 22,99



Furniture unit as finished part without technical package

Chic furniture unit incl. tall cupboard with sliding door, linen compartment, storage compartment for 2x 5 kg gas bottles. 2 drawers. A roll-up cupboard offers plenty of space (e.g. for the Porta-Potti Qube 335 chemical toilet, 660102). Cut-outs for the installation of gas, water, hot air and electric are already made. Furniture unit without technology, appliances and installation. Décor: white laminate

15081 2789,-



Technical package built into the furniture above:

The technical package includes: Sink-cooker combination with glass cover, 2x 12 l fresh water canister, 27 l waste water canister, water tap, submersible pump 18 l and hoses, compressor refrigerator (Dometic CRP 40, approx. 39 l), gas system prepared for 2x 5 kg gas bottle. 12 V/230 V system with Reimo fuse panel 714, Carbest switch-mode charger 15 A, circuit breaker 13 A with Fi, CEE input socket and connection parts. 24 LED aluminium line light in kitchen part.

15081M 7399,-



Truma VarioHeat eco gas heater

Fitted in furniture unit, incl. chimney. The opening for the chimney as well as the chimney must still be attached to the vehicle.

720304E 2431,22



Table system with swivel table frame

Slides forward with the bench. Table top approx. 85x47 cm. Tabletop made of laminate. Décor: slate

10694S 629,-



Hanging roof cupboard

As prefabricated part above rear bench seat for additional storage space. Cabinet pre-assembled. Only in conjunction with sleeping roof. Décor: Apple laminate

15082 435,-



Porta Potti 335 portable camping toilet

Suitable for furniture line. High quality plastic for maximum hygiene

660102 144,95

REIMO CITYVAN - MERCEDES BENZ VITO

Based on Mercedes Benz Vito long station wagon (overall length 514 cm) as built of 8/2014

True multifunctional mobile.

Multifunctional driving pleasure in perfection with extensive standard equipment for high demands
The generous space concept and versatility open up limitless possibilities.



Technical specifications

CityVan short wheelbase:

Sleeping berths on sleeper/seat bench:	2 - 4
Sleeping berths with sleeping roof:	4
Clear bed dimensions :	198x140 cm
Sleeping/seating bench:	Variotech® 3000
Seats with three-point belts:	5 - 6
Cooker:	1-burner gas, or spirit
Refrigerator:	Compressor cooler (26 l)
Furniture construction:	Poplar plywood with HPL Laminate and postforming edges
Fresh water / waste water	13 l / 13 l
Wardrobe: approx. 57 x 24 x 82 cm / approx. 112 l	
Overhead locker: 123 x 27 x 11 cm / approx. 36 l	
Rear storage space	
- with / without bench seat:	2900 l / 4400 l
- under bed extension:	DxWxH 60x121x37 cm
- under bench:	60 x 31 cm
Loading capacity:	2,4 m

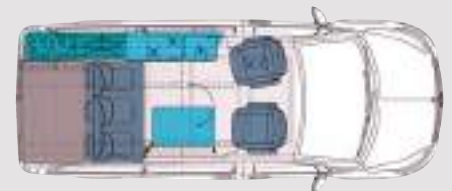

Daytime position

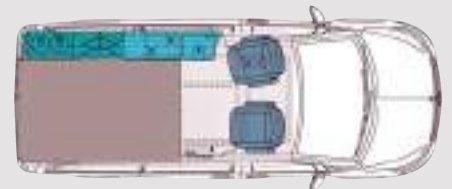

Night position



Please ask your dealer for further equipment and options
Your specialist dealer. Some of the illustrations show optional
equipment,
which are not included in the scope of delivery.



Sleeping/seating bench Variotech® 3000

Three-seater, size 14, total width: 1305 mm. Upholstery width: 1250mm, sleeping area: 1980x1400mm. 3 integrated, retractable headrests, 3 seat belts, Isofix attachment points for a maximum of 2 child seats (middle seat cannot be used when a child seat is used), fold-up rear upholstery (storage space height under rear upholstery: 46 cm), side panel. Fully upholstered incl. rear cushion. Sliding and removable bench. Rail spacing 1050 mm. Fabric design: Classic Grey, 2-coloured.

5045000 4359,-

"Grizzly" slide rail set

2 aluminium slide rails, silver anodised for Vito long. Length: 286 cm, 4 different driving positions.

58326 508,-

Floor adapter for steel For "Grizzly" slide rail set for long wheelbase. For mounting the slide rails on the vehicle floor. Rail distance 1050mm.

Right side type 1 **58327 240,90**

Middle type 2 **583271 290,40**

Fastening set For slide rail set "Grizzly" for short wheelbase. For fastening the slide rails to the vehicle floor. Rail spacing 1050 mm.

58328 339,90



Drawer

Provides additional storage space for e.g. shoes, cables or board tools. The drawer can be removed for loading long parts. Dimensions HxWxD: approx. 17x66,5x69,5 cm. Decor: Basalt

5045090 639,-

Front panel

Installed on the bench instead of a drawer. The front panel is removable and therefore offers a through-loading possibility for e.g. surfboard or skis up to a length of max. 2,4m. (Loading dimensions under the bench HxW approx. 31x75 cm. Decor: Basalt

5045080 249,-



Base plate 3-pcs

made of waterproof chipboard with PVC covering. Rail spacing 1050 mm. For MB VITO. Decor: ship's floor

168071 435,-

X-Trem insulator, 18 mm thickness

Extremely heat insulating and very light insulation. Is needed under the base plate 3x for LR. Supplied as panels with a 2 x 1 m.

50009 22,99



Furniture unit as finished part without technology package:

Elegant furniture part with cover flaps. Prepared for installation of water system, compact sink and cool box. Standard decor: high-gloss anthracite-silver

15083 4635,-



Technical package installed in the above furniture unit

The water system consists of: Stainless steel basin 325 x 176 mm, automatic water tap, 2x 13-litre canisters, submersible pump, 12 V connection parts, water hose (10 and 19 mm), and small parts. Slim cooler with plenty of space and only approx. 200 mm depth. Temperature range from +1° C to 10° C. External cooling unit, Danfoss BD 2.5 compressor. Dimensions: approx. W 570 x D 200 x H 360 mm Weight approx. 18,9 kg.built-in.

Water systems **60004E 389,-**

Water systems with fuse panel 713 **60004EE 495,-**

Compressor cooler 26L **71177E 1319,-**



Diesel heater Breeze Small, compact heater for mounting under the passenger seat. Power: 2,7 KW, fuel consumption max. 0,33 l/h. Power consumption: 74-130 W. Dimensions: L 355 x W 124 x H 126 mm

48129 698,99

Digital control panel **48130 139,90**

Fuel tank extraction set **707191 107,50**



Table system with swivel table frame With wall bracket and folding table base. Table top in laminate decor Mandarin approx. 85 x 47 cm. Table edge: high gloss silver

12003S 169,74

Swiveltable support stainless steel

571300M 317,90



Hanging roof cupboard for EasyFit sleeping roof with slatted bed

As prefabricated part above rear bench seat for additional storage space. Cabinet pre-assembled. For short or long wheelbase with decor: high-gloss anthracite-silver

15085 445,-



PortaPotti kit For mounting the Porta Potti toilet. When the kit is fitted, the bench cannot be pushed all the way forward. (Without Porta Potti toilet) Decor: High gloss anthracite-silver

15089 465,00

Porta Potti 335 portable camping toilet

Suitable for Porta Potti kit .High quality plastic for maximum hygiene

660102 144,95

REIMO WEEKENDER - MERCEDES BENZ VITO

Based on Mercedes Benz Vito long station wagon (overall length 514 cm) as built of 8/2014

Large capacity van for up to 5 people.

- Large flat sleeping surface over the entire inside width with high lying comfort - without disturbing seams or straps
- Sliding and removable 3-person bench seat with integrated 3-point seat belts as well as retractable head restraints and Isofix holders for 2 child
- Load-through option for long items when drawer or front panel is removed



Whether for business, everyday life or leisure - the Reimo Weekender is the perfect first vehicle for every occasion

The all-round talent Weekender is in everyday life and work a large-capacity sedan with plenty of freedom of movement for the passengers and ample storage space in the rear

In leisure time it becomes with the optional kitchen block the perfect travel companion with 2 - 4 full sleeping berths. (Sleeping roof optional)



Please ask your dealer for further equipment and options
Your specialist dealer. Some of the illustrations show optional equipment, which are not included in the scope of delivery.

Technical specifications

Sleeps on sleeping/seating bench:	2
Sleeps with optional sleeping roof:	4
Light bed dimensions with storage box :	198x140 cm
Sleeping/seating bench:	Variotech® 3000
Seats with three-point belts:	5
Rear storage space:	
- with / without bench seat:	3400 l / 5200 l
- under bed extension:	DxWxH 60x126x37 cm

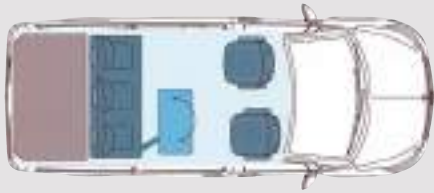

Daytime position

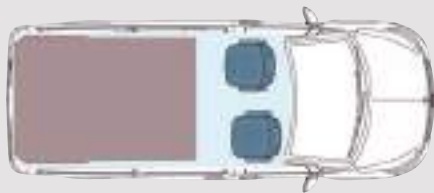

Night position



Sleeping/seating bench Variotech® 3000

For vehicles without side plastic panelling. Three-seater, size 17, total benchwidth: 1380 mm .Upholstery width: 1330 mm, sleeping area: approx. 1980x1600 mm. 3 integrated, retractable headrests, safety belts. Isofix attachment points for max. 2 child seats (middle seat cannot be used when a child seat is used), fold-up rear upholstery (storage space height under rear upholstery: 46 cm), front trim and side trim. Fully upholstered incl. rear cushion. Sliding and removable bench. Rail spacing 1050 mm. Fabric design: Classic Grey, 2-coloured.

5045100 4359,-

"Grizzly" slide rail set

For Variotech® 3000

58326 508,-

Floor adaptation steel

for rail spacing 1050 mm

58327 240,90

Fastening set

For slide rail set "Grizzly" for short wheelbase. For fastening the slide rails to the vehicle floor. Rail spacing 1050 mm.

583282 185,90



Drawer

Provides additional storage space for e.g. shoes, cables or board tools. The drawer can be removed for loading long parts. Dimensions HxWxD: approx. 17x83,5x69,5 cm. Décor: Basalt

5045190 679,-

Front panel

Installed on the bench instead of a drawer. The front panel is removable and therefore offers a through-loading possibility for e.g. surfboard or skis up to a length of max. 2,4m.

(Loading dimensions under the bench HxW approx. 31x60 cm). Décor: Basalt

5045180 249,-



Base plate 3-pcs

made of waterproof chipboard with PVC covering. For original Mercedes Benz Vito door sill trim decor: ship's floor

168071 435,-

X-Trem insulator, 18 mm thickness

Extremely heat insulating and very light insulation. Is needed under the floor panel 3xfor long wheelbase. Supplied as panels with a 2 x 1 m.

50009 22,99



Diesel heater Breeze Small, compact heaterfor

mounting under the passenger seat. Power: 2,7 KW, fuel consumption max. 0,33 l/h. Power consumption: 74-130 W. Dimensions: L 355 x W 124 x H 126 mm

48129 698,99

Digital control panel **48130 139,90**

Tank extraction set **707191 107,50**



Multifunctional table system

With swivel table frame. Slides forward with the bench. Table top approx. 85 x 47 cm. Laminate wood decor slate

10694S 629,-



Hanging roof cupboard for EasyFit sleeping

roof with slatted bed: As prefabricated part above rear bench seat for additional storage space. Cabinet pre-assembled. For long wheelbase with decor: apple laminate

15085 445,-

REIMO VAN-CONCEPT

RENAULT TRAFIC OPEL VIVARO FIAT TALENTO NISSAN NV 300

The Reimo TrioStyle camping equipment for Renault, Opel, Fiat and Nissan leaves nothing to be desired on holiday or in your leisure time.

The exclusive furniture line with full equipment and a lot of storage space offers highest comfort for individual holiday trips.

The large sleeping area, which extends over the entire width of the vehicle, guarantees the best sleeping comfort on the road.



- CONTENTS -

REIMO TRIOSTYLE	90-91
REIMO WEEKENDER	92-93



REIMO TRIOSTYLE - RENAULT/OPEL/FIAT/NISSAN

Based on Renault Trafic/Opel Vivaro B Kombi up to 3/2019 /Fiat Talento/Nissan NV300 (kR) as of MY 7/2014

Travel without compromise.

- The exclusive camper with full equipment and chic furniture line
- For up to 7 passengers, with two additional single seats (all seats with three-point seat belts)
- Plenty of storage space in the rear thanks to sliding and removable sleeper/seat bench



Sleeping/seating bench for 3 persons. Exclusive kitchenette with all comforts: Large 40 litre compressor fridge, wardrobe with linen compartment, storage compartment, suitable for portable camping toilet, swivelling work and dining table.



Please ask your dealer for further equipment and options
Your specialist dealer. Equipment for the long wheelbase can be found at: www.reimo.com. Some of the illustrations show optional equipment that is not included in the scope of delivery.



Technical specifications

TrioStyle short wheelbase:

Sleeping berths on sleeper/seat bench	2
Sleeping berths with optional sleeping roof	4
Clear bed dimensions	195 x 125 cm
Roof bed dimension:	187 x 140 cm
Sleeping/seating bench:	Variotech® 3000
Seats with three-point belts	5
Cooker:	2-burner gas stove
Refrigerator	Compressor fridge
	Dometic CRP 40 (approx. 39 l)* Gas capacity
Space for 2x 5 kg gas bottle	Furniture construction:
	Poplar plywood with HPL laminate
Fresh water / waste water	2x 12 l / 43 l Tall cabinet
	104 x 127 x 38 cm
Hanging roof cupboard:	123 x 27 x 11 cm / approx. 36 l
Rear storage space	
- with / without bench seat:	2260 l / 3950 l
- under bed extension:	DxWxH 65x106x40 cm
- under bench:	43 x 75 x 28 cm / 90 l

*Included in the technical package

Permissible total mass 2700 kg Payload without sleeping roof approx. 380 kg Payload with sleeping roof approx. 320 kg

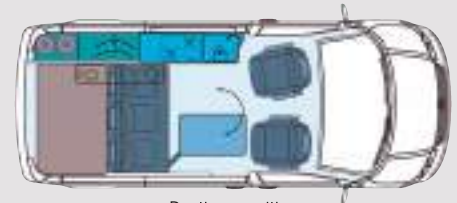

Daytime position



Night position





Sleeping/seating bench Variotech® 3000

Three-seater, size 10 Total width: 1205 mm, cushion width: 1150 mm, sleeping area: 1960x1210 mm. 3 integrated, retractable headrests, 3 seat belts, Isofix attachment points for a maximum of 2 child seats (middle seat cannot be used when a child seat is used), fold-up rear upholstery (storage height under rear upholstery: 46 cm), 1 side panel. Fully upholstered incl. rear cushion. Sliding and removable bench. Rail spacing 673 mm. Fabric design: Classic Grey, 2-coloured.

5044000 4359,-

"Grizzly" slide rail set For Variotech® 3000

58128 460,90

Floor reinforcement, steel 1-piece.

Required for installation of the floor rail. Short/long wheelbase

581251 Front 196,90

581252 Rear 339,90

Fastening set For slide rail set "Grizzly" for short wheelbase. For fastening the slide rails to the vehicle floor. Rail distance 673 mm.

58133 218,90



Drawer

Provides additional storage space for e.g. shoes, cables or board tools. The drawer can be removed for loading long parts. Dimensions HxWxD: approx. 17x49,5x69,5 cm. Décor: Basalt

5044090 679,-

Front panel

Installed on the bench instead of a drawer. The front panel is removable and therefore offers a through-loading possibility for e.g. surfboard or skis up to a length of max. 2,4m. (Loading dimensions under the bench HxW approx. 31x60 cm. Décor: Basalt

5044080 249,-



Base plate 3-pcs

made of waterproof chipboard with PVC covering. For Renault Trafic and others. 673mm rail spacing Décor: ship's floor

141142 434,-

X-Trem insulator, 18 mm thickness

Extremely heat insulating and very light insulation. Is needed under the floor plate 2x for kR. Supplied as panels with a 2 x 1 m.

50009 22,99

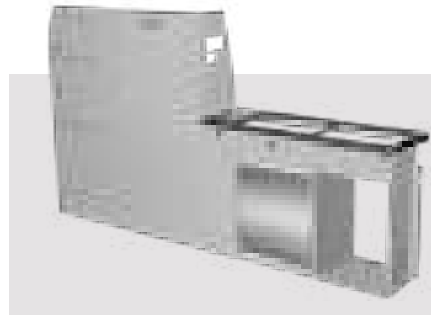

Furniture unit as finished part, including built-in technology package

Exclusive furniture unit with continuous front in apple decor. Large wardrobe with sliding door, linen compartment and storage compartment for 2x 5 kg gas bottles. The kitchen section offers you space for the Porta-Potti Qube 335 chemical toilet (660102), with 2 drawers and a roll-up cupboard, as well as plenty of space for provisions and equipment. Cut-outs for the installation of gas, water, hot air, electrical as well as other assembly preparations are already made.



The technical package includes: Sink/stove combination with glass cover, 2x 12 l fresh water canister, 27 l waste water canister, water tap, submersible pump 18 l and hoses, compressor refrigerator (Dometic CRP 40, approx. 39 l), gas system prepared for 2x 5 kg gas bottle. 12 V/230 V system with Reimo fuse panel 714, Carbest switch-mode charger 15 A, circuit breaker 13 A with Fi, CEE input socket and connection parts. 24 LED aluminium line light in kitchen part. Décor furniture line: laminate high gloss silver

16050M 7929,-



Truma VarioHeat eco gas heater

Fitted in furniture unit, incl. chimney. The opening for the chimney as well as the chimney must still be attached to the vehicle.

720304E 2431,22



Table system with swivel table frame

With wall bracket and folding table base. Table top in laminate decor slate, approx. 77x48 cm. Table edge in silver.

18052 289,-



Hanging roof cupboard for EasyFit sleeping roof with slatted bed: As prefabricated part above rear bench seat for additional storage space. Cabinet pre-assembled. For short or long wheelbase with decor: laminate, high-gloss silver

160547 459,-



Porta Potti 335 portable camping toilet

Suitable for TrioLoft furniture line. High quality plastic for maximum hygiene

660102 144,95

REIMO WEEKENDER - RENAULT/OPEL/FIAT/NISSAN

Based on Renault Trafic/Opel Vivaro B Kombi up to 3/2019/Fiat Talento/Nissan NV300 (kR) as of 7/2014

Large capacity van for up to 5 people.

- Large flat sleeping surface over the entire inside width with high lying comfort - without disturbing seams or straps
- Sliding and removable 3-person bench seat with integrated 3-point seat belts as well as retractable head restraints and Isofix holders for 2 child
- Load-through option for long items when drawer or front panel is removed



Whether for business, everyday life or leisure - the Reimo Weekender is the perfect first vehicle for every occasion

The all-round talent Weekender is in everyday life and work a large-capacity sedan with plenty of freedom of movement for the passengers and ample storage space in the rear

In leisure time it becomes with the optional kitchen block the perfect travel companion with 2 - 4 full sleeping berths. (Sleeping roof optional)



Please ask your dealer for further equipment and options from your dealer. Some of the illustrations show special equipment that is not included in the scope of delivery.



Technical specifications

Weekender:

Sleeps on sleeper/seat bench	2
Sleeps with optional sleeping roof	4
Light bed dimensions with storage box	205 x160 cm
Sleeping/seating bench:	Variotech® 3000
Seats with three-point belts	5
Rear storage space	
- with / without bench seat:	3000 l / 5000 l
- under bed extension:	DxWxH 65x126x40 cm



Daytime position



Night position



Sleeping/seating bench Variotech® 3000

For vehicles without side plastic panelling. Three-seater, size 17, total benchwidth: 1380 mm .Upholstery width: 1330 mm, sleeping surface: approx. 1960x1600 mm. 3 integrated, retractable headrests, safety belts. Isofix attachment points for max. 2 child seats (middle seat cannot be used when a child seat is used), fold-up rear upholstery (storage space height under rear upholstery: 46 cm), front trim and side trim. Fully upholstered incl. rear cushion. Sliding and removable bench. Rail spacing 1020 mm. Fabric design: Classic Grey, 2-coloured.

5044300 4549,-

"Grizzly" slide rail set For Variotech® 3000

581280 460,90

Fastening set For "Grizzly" sliderail set for short wheelbase. For fastening the slide rails to the vehicle floor. Rail spacing 1020 mm.

58135 236,41



Drawer

Provides additional storage space for e.g. shoes, cables or board tools. The drawer can be removed for loading long parts. Dimensions HxWxD: approx. 17x83,5x69,5 cm. Decor: Basalt

5044390 379,-

Front panel

Installed on the bench instead of a drawer. The front panel is removable and therefore offers a through-loading possibility for e.g. surfboard or skis up to a length of max. 2,4m. (Loading dimensions under the bench

HxW approx. 31x60 cm. Decor: Basalt

5044380 249,-



Base plate 3-pcs

made of waterproof chipboard with PVC covering. For original TRAFIC and others 1020mm rail spacing. Decor: ship's floor

141146 434,-

X-Trem insulator, 18 mm thickness

Extremely heat insulating and very light insulation. Is needed under the floor panel 2x for kR. Supplied as panels with a 2 x 1 m.

50009 22,99



Table system with swivel table frame. Slides forward with the bench. Table top approx. 85 x 47 cm. Laminate anthracite slate

106945 547,-



REIMO VAN-CONCEPT

FORD TRANSIT CUSTOM

The comfort camper with plenty of space. Thanks to its wider interior to comparable models in its vehicle class, the Ford Transit Custom offers noticeably more living space in the vehicle.

In combination with the Reimo TrioStyle camping equipment your individual camping dream vacations are already guaranteed before the start of the journey.

– CONTENTS –

REIMO TRIOSTYLE FOR FORD TRANSIT CUSTOM96-97

REIMO TRIOSTYLE - FORD TRANSIT

Based on Ford Transit Custom, short wheelbase station wagon (L1/H1) + flat roof

Five stars on wheels.

- Exclusive camping full equipment
- 5 three-point seat belts allow 5 people to travel (up to 6 people with optional single seat)
- Plenty of storage space in the rear as well as under the bench seat
- Seat bench can be moved and easily removed
- Swivelling working/dining table
- Easily accessible water/waste water canisters in the rear



A clever extension highlight is the storage flap integrated into the underside of the bed. It allows quick access to travel utensils and luggage in the boot from inside the vehicle when the bench seat is converted into a sleeping bench.

This means you don't necessarily have to leave the vehicle, which is particularly practical in bad weather.



Sleeping/ seating bench for 2/3 persons. Kitchen with all comforts: fridge*, large wardrobe with linen compartment and swivel work and dining table.

Technical specifications

Sleeps on sleeping/ seating bench:	2
Sleeps with optional sleeping roof:	4
Light bed dimensions :	209x134 cm
Sleeping/ seating bench:	Variotech® 3000
Seats with three-point seat belts:	5
Cooker:	2-burner gas stove*
Refrigerator:	Compressor fridge
	Dometic CRP 40 (39 l)*
Gas capacity:	Space for 2x 5 kg gas bottle
Furniture construction:	Poplar plywood with HPL
	Laminate and postforming edges
Fresh water / waste water: =	2x 12 litres*
Wardrobe: approx. 57x24x82 cm/ approx. 112 litres	

Tall cupboard:	120/82 x 58 x 26/20 cm / 120 l
Overhead cupboard:	97 x 36 x 9 cm / approx. 32 l
Rear storage space:	
- with / without bench seat:	2700 l / 4200 l
- under bed extension:	DxWxH 61x115x40 cm
- under bench:	43 x 75 x 28 cm / 90 l

*Included in the technical package

Permissible total mass	3000 kg
Payload without sleeping roof:	approx. 598 kg
Payload with sleeping roof :	approx. 543 kg

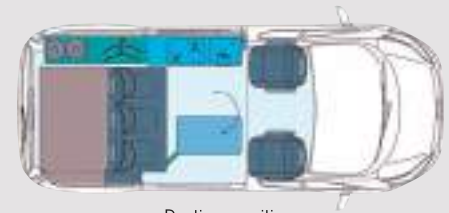

Daytime position

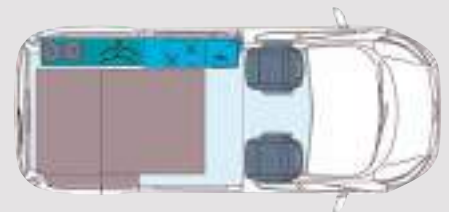

Night position



Please ask your dealer for further equipment and options
Your specialist dealer.
Some of the illustrations show optional equipment, which are not included in the scope of delivery.



Sleeping/seating bench Variotech® 3000

Three-seater, size 10, total width: 1205mm, upholstery width: 1150 mm, sleeping surface approx. 2020x1300 mm. 3 integrated, retractable headrests. 3 safety belts, Isofix attachment points for a maximum of 2 child seats for the outer seats (middle seat cannot be used when a child seat is used), fold-up rear upholstery (storage space height under rear upholstery: 46 cm), side panel. Fully upholstered incl. rear cushion. Sliding and removable bench. Rail spacing 766mm. Fabric design: Classic Grey, 2-tone

5042000 4249,-

Including "Grizzly" slide rail set

2 aluminium slide rails, silver anodised for Ford Transit Custom. Length: 286 cm, 4 different driving positions.

581960 537,64

Floor adaptation made of steel 4-piece

For installation of the slide rail prescribed with screw set.

58193 515,90



Drawer

Provides additional storage space for e.g. shoes, cables or board tools. The drawer can be removed for loading long parts. Dimensions HxWxD: approx. 17x49,5x69,5 cm. Décor: Basalt

5042090 679,-

Front panel

Installed on the bench instead of a drawer. The front panel is removable and therefore offers a through-loading possibility for e.g. surfboard or skis up to a length of max. 2,4m. (Loading dimensions under the bench HxW approx. 31x60 cm. Décor: Basalt

5042080 249,-



Floor plate 3-pcs

made of waterproof chipboard with PVC covering for Ford Custom short wheelbase. Décor: ship's bottom

105230 399,-

X-Trem insulator, 18 mm thickness

Extremely heat insulating and very light insulation. Is required under the floor slab. Plate size 2 x 1 m. (You need 3 plates). 1 pc.

50009 22,99

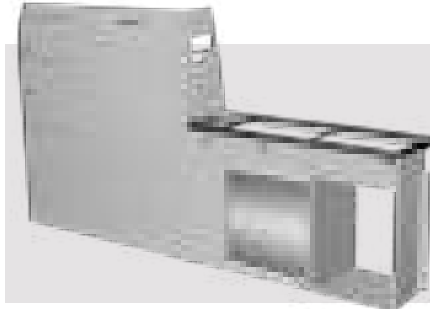

Furniture unit finished part without technical package :

Chic furniture part with large wardrobe with sliding door, linen compartment and storage compartment for 2x 5 kg gas bottles. The kitchen section offers you space for the Porta-Potti Qube 335 chemical toilet (660102) with 2 drawers and a roll-up cupboard, as well as plenty of space for provisions and equipment. Cut-outs for the installation of gas, water, hot air and electric are already made. Décor: High gloss silver

180806 4779,-



Technology package built into the above furniture unit

Built into the furniture unit as standard. Sink and cooker with glass cover fit perfectly into the slate-coloured worktop. Gas system prepared for 2x 5 kg gas bottle, compressor fridge Dometic CRP 40 (approx. 39 l), 12 V/230 V system with Carbest switch-mode charger 20 A, 12 and 230 V socket, automatic circuit breaker 13 A with FI, AGM battery 100 Ah, input socket and LED light are supplied for connection in the vehicle. 2x 12-litre fresh water canister with tap and 18-litre submersible pump. 27-litre waste water tank with mounted connections is supplied for installation in the vehicle behind the kitchen section

180806E 3619,-



Truma VarioHeat eco gas heater

Fitted in furniture unit, incl. chimney. The opening for the chimney as well as the chimney must still be attached to the vehicle.

720304E 2431,22



Table system with swivel table frame

With swivel table frame. Slides forward with the bench. Table top approx. 85 x 47 cm. Laminate wood decor slate

18082 367,-



Overhead locker: As a prefabricated part above the rear bench seat. Can be used as additional storage space. Only in combination with sleeping roof. High gloss silver

180816 454,-



Sideboard

The sideboard is next to the bench and also serves as a bed extension incl. cushion

50420M 449,-



Porta Potti 335 portable camping toilet

Suitable for TrioStyle furniture line. High quality plastic for maximum hygiene

660102 144,95



- CONTENT -

REIMO TRIP100-101

REIMO VAN-CONCEPT

CITROËN SPACETOURER PEUGEOT TRAVELLER TOYOTA PROACE VERSO OPEL ZAFIRA D LIFE

With the Reimo Trip extension your everyday vehicle becomes a true all-rounder with smart camping equipment.

Modern design and high-quality materials provide a feel-good ambience in the vehicle and the enormous variability offers a completely individual use for vacation and leisure.



REIMO TRIP - CITROËN SPACETOURER

Based on Citroën Spacetourer M and identical in construction, with original seating in rail system

The all-rounder with smart camping - equipment

- Modular furniture line in elegant design
- Highest variability due to fastening in floor rails
- Thus possibilities of use as 2-8 seater, camper and transporter
- Both furniture modules can be used independently of each other
- Bed module using the original 2-seater bench



With the Reimo Trip conversion based on Citroën Spacetourer/Peugeot Traveller or vehicles of the same design, you are particularly flexible on the road thanks to the modular conversion.



Modern design language, noble and robust materials and the enormous variability in use make the extension an all-rounder and design highlight.

Maximum variability is achieved by anchoring in the original floor rails: This enables use as a camper as well as an everyday vehicle (2-8 seater) and transporter in equal measure. The modules can either be permanently installed or removed without tools.

No modification to the base vehicle is required to install the modules.

Also suitable for the following vehicles:

Peugeot Traveller from 2016 model year, Toyota Proace Verso from 2016 model year, Opel Zafira D Life (length 4.96 cm) from 2019 model year

Technical specifications

Citroën Spacetourer

Sleeping berths on sleeper/seat bench:	1
Sleeping berths with optional sleeping roof:	3
Light bed dimensions with storage box:	198 x 85/95 cm
Sleeping/seating bench:	2-seater standard bench
Seating capacity with three-point seat belts:	4 to 8
Refrigerator:	Compressor fridge (40 l)
Cooker:	1-burner gas cartridge
Fresh water:	16 ltr. jerrycan
Waste water:	16 ltr. jerrycan
Rear storage space under bed:	
	approx. 140 x 65 x 43 cm
Storage space at bench seat:	60 x 65 x 43 cm

(data according to manufacturer)

Vehicle length (kR)	approx. 4956 mm
Vehicle width	approx. 1920 mm
Vehicle height without roof (kR)	approx. 1890 mm
Vehicle height with roof (kR)	approx. 2000 mm

Permissible total mass:	approx. 2780 kg
Payload:	approx. 1360 kg



Daytime position



Night position

Please ask your dealer for further equipment and options
Your specialist dealer. Some of the illustrations show optional equipment, which are not included in the scope of delivery.



Bed module

The module is screwed into the floor rails of the vehicle and can be removed if necessary. Comfortable single bed with sleeping surface approx. 198 x 90 cm. The bed consists of a frame and foldable cushions, which lie on the folded down Original seat. Upholstery black 100 % polyester

18373 Bed module **429,-**



Kitchen module

The module is screwed into the floor rails of the vehicle and can be removed if necessary. With 2 roller shutter doors. With built-in stainless steel sink, recessed in the worktop. Prepared for 2 x 16-litre water canisters. The kitchen module offers enough space for camping equipment and the optional 1-flame cartridge cooker. Pearl black decor

18370 **1999,-**



Water system built into kitchen module

Consisting of: Water system with pull-out tap + hose (for outdoor shower function), submersible pump 18 l and 1 x 16 l fresh and waste water canister each and cable plug connection.

18375 **749,-**



Cooling box module

The module is screwed into the floor rails of the vehicle and can be removed if necessary. In the rear area there is a storage compartment with door. The cooling box module is prepared for the 40 l compressor cooling box, which is loaded from above. Decor Pearl Black

18371 **1998,-**

Technology package for cooling box module

Consisting of: 40 l compressor coolbox, 12 V system with AGM battery 60 Ah., charge booster and cable plug connection.

18377 Installed in coolbox module **2299,-**

Technology package 230 V as kit Consisting of: Carbest switch-mode charger 20 A, CEE input socket, 13 A circuit breaker with RCD switch, charge booster, 1 x 230 V built-in socket and 12 V built-in socket. The 230 V kit is installed under the passenger seat and is supplied as a kit.

18378 **369,-**



Table system with wall bracket

With folding table base and bracket for hanging on the kitchen module. Table top HPL Pearl Metallic 15 mm size:76 x 46 cm. The table is stored behind the furniture unit.

18372 **254,-**



FURNITURE DECORS - FLOORING

Overview of furniture decors and floor plates for all extension furniture

Furniture decors



High gloss white or silver Poplar plywood with 0.6 mm HPL coating (High Pressure Laminate), on both sides



Pearl black poplar plywood with 0.6 mm HPL coating (High Pressure Laminate), on both sides



Anthracite metallic poplar plywood with 0.6 mm Laminate coating, on both sides



High gloss Olive Poplar plywood with 0.6 mm HPL coating (High Pressure Laminate), on both sides



Walnut poplar plywood with 0.6 mm HPL coating (High Pressure Laminate), on both sides



Apple poplar plywood with 0.6 mm HPL coating (High Pressure Laminate), on both sides



Poplar plywood natural - T3 on both sides



Granitto - T3/T4/T5/T6 Poplar plywood with 0.6 mm HPL coating (High Pressure Laminate), on both sides

Conversion Furniture decor	VW Caddy	VW T3	VW TrioLoft	VW Multi Style	VW Sport Camper	VW Travel Style	VW Week-enderPlus	TrioStyle	VW/Mercedes CityVan	Citroen Trip
High gloss white	● Camp			○				○ VW/Ford ● Mercedes	○	
High gloss silver								● Ford ● Renault		
Pearl Black										●
Anthracite metallic							●		●	
High gloss olive/white	● Active		●							
Walnut						●				
Apple laminate				●	●			● VW		
Poplar plywood nature		● Jolly								
Granitto		● Speedy ● Florida								
Floor panels										
Ship's floor	● Camp	●	●	●	●	●	●	●	●	
Ticino		○	○	○	○	○	○	○	○	
Quad		○	○	○	○	○	○	○	○	
Granitto	● Active									

● Standard equipment / ○ Option with surcharge

Floor covering



Floor panel ship's floor series waterproof glued chipboard with vinyl floor covering, 10 mm thickness



Floor panel Tessin with surcharge waterproof glued chipboard with robust vinyl flooring, 10 mm



Floor panel Quad with surcharge waterproof glued chipboard with vinyl flooring, 10 mm thickness



Granitto - T3/T4/T5/T6 Poplar plywood with 0.6 mm HPL coating (High Pressure Laminate), on both sides

Upholstery fabric series all vehicles

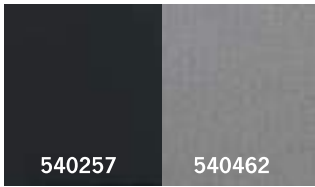

Standard fabric
Classic dark grey/grey
 100% polyester,
 3 mm foam laminated

The illustrations of the upholstery fabrics show the side fabric pattern on the left and the fabric of the seat and backrest on the right



Upholstery fabrics VW Transporter against surcharge

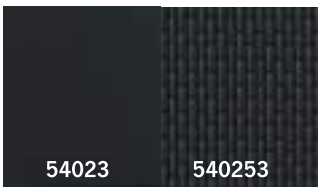

Titanium black/Bricks
 VW T6.1 original fabric, 100% polyester, 4 mm foam laminated

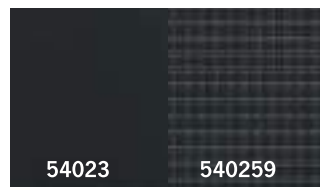

Titanium black/DoubleGrid
 VW T6.1 original fabric, 100% polyester, 3 mm foam laminated

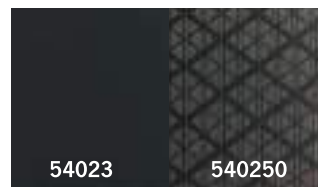

Titanium black/quadratic
 VW T6.1 original fabric, 100% polyester, 3 mm foam laminated

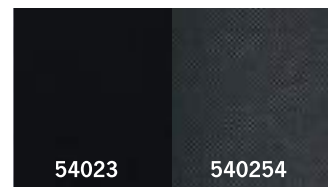

Titanium black/Austin
 VW T6 original fabric, 100% polyester, 4 mm foam laminated

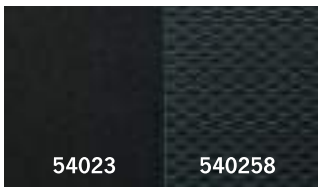

Titanium black/Simora
 VW T6 original fabric, 100% polyester, 4.5 mm foam laminated

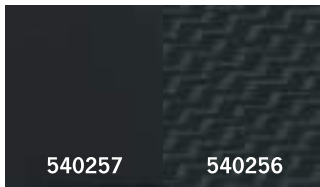

Dark grey/Tasamo
 VW T5 original fabric, 100% polyester, 4.5 mm foam laminated



Classic Grey/T5 Austin
 VW T5 original fabric, 100% polyester, 4 mm foam laminated

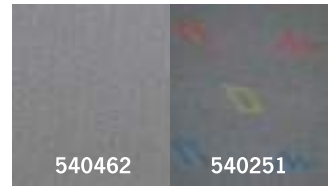

Classic grey/Inka
 VW T5 original fabric, 100% polyester, 5 mm foam laminated

Upholstery Mercedes against surcharge



Uni Black/Caluma
 Original Mercedes Vito fabric, flat weave made of polyester, polyurethane, nylon

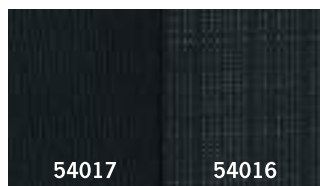

Black/Tunja
 original fabric Mercedes Vito, 100% polyester, flat weave

Upholstery fabrics Ford against surcharge

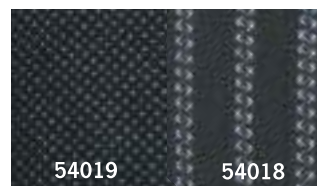

Trend/Blue Stripe
 original fabric Ford, 100% polyester, 2 mm foam laminated

Upholstery Renault, Opel, Nissan, Fiat against surcharge

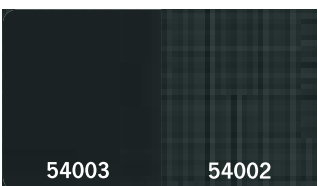

Black/Compo, 2-coloured
 Renault original fabric, 100% polyester, 2 mm foam laminated and flat weave. Surcharge

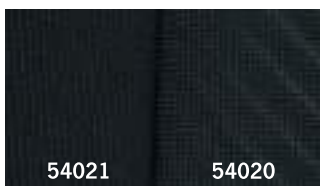

Black/Black Patterned, 2-coloured - from 2014
 Renault original fabric, 100% polyester, 2 mm foam laminated and flat weave. Surcharge

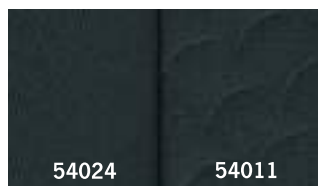

Black/Black scale, 2-coloured
 Opel original fabric, 100% polyester, 2 mm foam laminated and flat weave. Surcharge

More upholstery fabrics and leather see page 198-201



REIMO VAN - CONCEPT

REIMO MAXICAMPER

Reimo furniture modules that turn your Mercedes Sprinter into an individual camper van

With the Reimo self-assembly kits you can turn your van into a maxicamper according to your individual wishes and requirements.

– CONTENTS –

.....	
FURNITURE MODULES FOR MERCEDES BENZ SPRINTER	106-107
BANK SYSTEMS FOR VW CRAFTER	108
MODULES FOR SPRINTER	109
.....	

FURNITURE MODULES FOR MAKERS

With the new Reimo self-assembly kits for Mercedes Sprinter you can build your own individual camping bus according to your needs! With little effort you can also use the modules variably.

Furniture decor: Olmo



Sleeping berths/storage space Sleeping roof

If you need 2 more sleeping places, our Maxivan sleeping roof is the right thing for you. Suitable for Sprinter, Crafter, Ducato and as a universal roof for almost all large panel vans. More information in the Reimo camping bus conversion professional catalogue on page 136.

Rear bed for transverse sleeper, white furniture finish

1.88x1.32 m (with side extension) consists of:

Storage cupboard on the left with a compartment for 2 gas bottles 11 kg, space for combi-C- gas heater/boiler, large compartment for up to 2 living area batteries and storage space, dimensions approx. 130x85x62 cm.

Storage cupboard on the right, intended for 105 l fresh water tank 61199, additional storage space. Dimensions approx. 124x85x44 cm. In front of the rear door is storage space for a camping table. Alternatively, a canister water system can be stored in the kitchen section.

Foldable bed frame, ventilated

Between the cupboards under the bed is a stowage area 73 cm wide

1569001 1644,62

Bed cushion for rearbed, ready covered, 3 parts, high quality foam 10 cm thick. The dimensions of the bed cushion are adapted to the rope widening and can be shortened accordingly if required

1569002 516,47



Washroom/shower tray

Washroom for standard high roof

can be shortened for flat roof
2 side walls, rear wall, ceiling and double-wing door with magnetic lock
Dimensions HxWxD 190x91x79 cm

1569004 1239,-

Shower tray made of high-quality GRP, extension of the washroom into a shower room, with wheel housing cover, intended for toilet cassette CT4110, raw dimensions 110x85 cm, adaptable

16042 599,-



Overhead lockers

Storage space above the bench seat or in the sleeping area.

The overhead lockers are particularly easy to install, the shelves fit into recesses provided in the roof rails on the right and left and are then screwed to the supports at the top. Doors are positioned upwards with high-quality mechanisms.

Hanging roof cupboard, front left WxHxD 100x38x25 cm

1569010 519,-Hanging

roof cupboard, rear left WxHxD 114x38x25 cm

1569011 549,-

Overhead cupboard, rear right WxHxD 114x38x25 cm

1569012 549,-



06
Base plate
 The base for your further expansion is available as a ready-cut plate with a robust PVC coating or as a universal plate to cut to size yourself. An insulation of 15 mm with the Reimo X-Trem insulator is provided.

09
Cladding/insulation
 After the installation of windows and the insulation of walls and roof, the cladding of walls and doors is an issue. Depending on your preference, you can buy 3 mm cladding panels, prefabricated wooden cladding sets or deep-drawn cladding parts from Reimo.

04
Bench
 Depending on your taste and needs, you have great options here. Whether with an optional three-point belt frame for 2 additional registered seats or just a large seat box for comfortable sitting. Seat box as a comfortable seating area, with plenty of storage space. W xDxH 74x57x36 cm (not approved for passenger transport)

Contour milled base plate
 10 mm waterproof glued chipboard, PVC covering decor Tessin,
 Dimensions approx. 3,32x1,78m
15905 399,-

For the side and roof cladding we recommend our 3 mm cladding panels in combination with X-Trem insulator for insulation. Open sheet areas can be well covered with X-Trem Stretch Carpet felt.



Cladding panel Galloway
 3 mm plywood coated, 1,22x2,50 m
510071 74,95

Foam set for seat box
 wedge-shaped cut for better seating comfort
1569007 189,-

07
Kitchen module
 Kitchen unit with plenty of storage space. With space for sink and cooker, drawer for cutlery and space for pots and dishes. 4 drawers, 1 cupboard compartment
 Decor Olmo, worktop Pearl black, dimensions approx. HxWxD 91x93x46 cm
1569005 1279,-

Stretch Carpet dark grey, 10 sqm,
500840 139,-
 You will find further products in our accessories programme.

Upholstery set seat and backrest original fabric Sprinter uni black,
1569008 309,-



Alternatively you can also use a universal belt support from our program, clarify the registration in advance with your TÜV



10
Windows
 The agony of choice. If I want good insulation, I choose frame windows with double glazing, if I don't want the vehicle to be immediately recognizable as a motorhome, I choose all-glass windows, rigid or sliding. Reimo offers more than 10 different types of windows. For more details see the catalogue or our homepage.

05
Table system
 Suspended table with solid single table base and 2-piece swing-out table top.
1569009 349,-

08
Wardrobe
 with compartment for compressor fridge 50 l (713570) and wardrobe area, storage drawer as access aid on the floor Dimensions approx. HxWxD 190x42x50 cm
1569003 795,-



11
Body widening
 for 6 m Mercedes Sprinter, only for driver's side, extends the interior by approx. 80 mm, material: GRP, surface gelcoat white, paintable, mounting with Sikaflex
15096 459,-

RIDE COMFORT & EQUIPMENT

For large panel vans



VARIOTECH® seat/sleeper bench system 3100Q

The comfort solution for the VW Crafter 2 from 2017, tested according to ECE R14 + ECE R17

The system consists of a VARIOTECH® 3100 bench seat with 2 three-point belts and a special base with transverse sliding unit. For sleeping, the bench is moved approx. 200 mm sideways, seat width approx. 120 cm, sleeping surface approx. 140 x 195 cm. The bench is intended to be installed with a platform in the direction of the driver's cab. Platform height 80 mm. Delivery ready upholstered with cover fabric Classic grey, including sleeping accessories and installation material.

VARIOTECH® 3100Q 5049000 Price on request



Single seat A400

The approved seat with three-point belt for Mercedes Sprinter, VW Crafter and Fiat Ducato.

In combination with the aluminium slide rail the seat can be moved or removed. Choose between 2 base heights to find your comfort position. You need a right and a left pedestal. A maximum of 3 seats can be mounted in a row.

Single seat A400 with 2 armrests

Seatbelt connection left **59372 1199,-**

Belt connection right **59371 1199,-**

Seat base height 23 cm (seat height 41 cm)

left **59366 137,90**

right **59365 137,90**

Seat base height 28 cm (seat height 46 cm)

left **59368 137,90**

right **59367 137,90**

Aluminium slide rail, double row, for mounting one seat or several seats in a row. Per seat approx. 1 meter seat rail necessary. Length 2,40 m **59379 376,-**

Special glue (600 ml) for bonding the floor rail **593795 28,91**

RIDE COMFORT & EQUIPMENT

For large panel vans

Interior trim Mercedes Sprinter

Deep-drawn parts made of plastic, suitable for the upper half of the L2H2
The lower half can be made classically from 3 mm plates. Colour grey.

① Sliding door passenger side	40022	200,-
② Side panel behind sliding door, right	40023	249,-
③ Side panel front driver's side, left	40025	249,-
④ Side panel driver's side rear, left	40024	249,-
⑤ Rear left (in driving direction)	40021	99,90
⑥ Rear right (in direction of travel)	40020	99,90

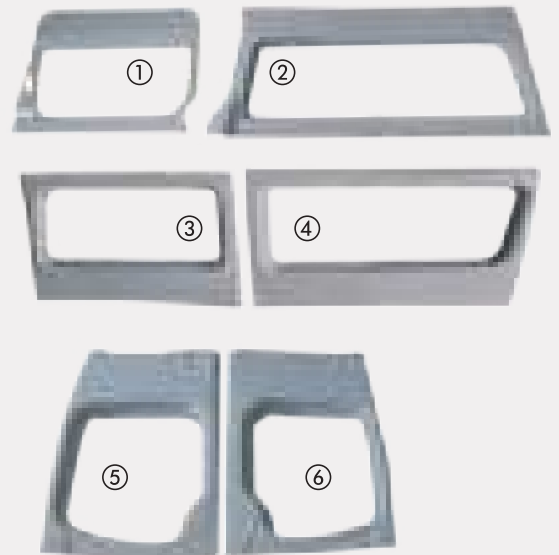

Body widening

Side widening (ear) VW Crafter from year of construction 2016, left, extends the interior by approx. 80 mm.

15095 491,13

Ditto right, behind the sliding door, extends the interior by approx. 40 mm.

150951 491,13



REIMO VAN-CONCEPT

VEHICLE- ROOFS

The extensive range of Reimo roofs offers a unique variety of variants for different base vehicles and uses.

Whether Pop Top roof, high roof or Pop Up roof, here you will find the solution for your needs.



- CONTENTS -

ROOF VARIANTS/ADVANTAGES OF REIMO POP TOP ROOFS	112-115
VW CADDY POP TOP ROOF.....	116
EASYFIT POP TOP ROOF VW T6.1/T6/T5.....	117-121
POP TOP / HIGH AND POP UP ROOFS FOR VW T6.1/T6/T5.....	122-124
POP TOP / HIGH AND POP UP ROOFS FOR VW T4/T3.....	125-128
POP TOP ROOFS FOR TOYOTA/HYUNDAI.....	129
POP TOP ROOFS FOR FORD/FIAT/CITROEN	130-131
POP TOP AND HIGH ROOFS FOR MERCEDES VITO/SPRINTER	132-133
POP TOP AND POP UP ROOFS FOR RENAULT TRAFIC	134-135
POP TOP ROOFS FOR MAXIVANS	136-137
ACCESSORIES FOR POP TOP ROOFS	139-140
SOLAR SYSTEMS FOR POP TOP ROOFS	141
UNIVERSAL POP UP ROOFS.....	142-143
SPARE PARTS FOR POP TOP AND POP UP ROOFS.....	144-145



THE RIGHT ROOF FOR YOUR CAR

Features of sleeping roof, elevating roof and high roof



Why a sleeping roof?

The Reimo sleeping roof offers the possibility to set up an additional bed with a lying surface of approx. 120 x 200 cm in a compact vehicle.

When set up at an angle, depending on the vehicle type, the interior height achieved is approx. 180 - 240 cm.

Depending on the model, the roof is equipped with up to 3 windows with mosquito nets, which, depending on the model, can be opened and provide good ventilation.

On most Reimo sleeping roofs you can transport loads up to approx. 30 kg (surfboard or similar). Optionally, the sleeping roofs can be equipped with solar panel or Sunroof.



Advantages of a high roof

The Reimo high roof has a solid GRP plastic shell and offers additional storage and living space. It is the solution for the camper who wants to be on the road in almost every season. The glass-fibre reinforced plastic shell is ideal for this, even in bad weather. The aerodynamic shape of the Reimo high roof keeps fuel consumption in check.

Depending on the type of vehicle, the roof cut-out can be of different sizes (between the crossbars or from windscreen to rear). For some roofs Reimo offers a GRP inner shell, ie: You have a clean, smooth and easy-to-clean inner surface in a simple, convenient way.

Reimo offers a velour interior lining for the Ergoline series. Here you are supplied with pre-glued 20 mm insulation panels covered with velour fabric.

The classic interior panelling with panelling panels: Here, a batten frame must be glued to the shell with Sikaflex adhesive, then insulated and the wooden cladding attached to it.

Roof hoods or windows can be fitted in a Reimo high roof for additional ventilation.

For transporting surfboards or similar, we recommend our carrier systems (see page 126).



Lifting roof: The inexpensive solution

The Reimo pop-up roof: The inexpensive option if standing height is only required in the kitchen/dressing area. The interior under the lifting roof is increased by approx. 45 cm, this allows standing height on an area of approx. 1m².

Depending on the vehicle type, the roof adds approx. 6-12 cm. Good ventilation is provided by 3 windows with mosquito netting that can be closed with canvas.

The lifting roof is to be set up parallel. It is usually mounted in the area of the sliding door.



NOTE To ensure that you enjoy your correctly installed sleeping roof for a long time, sleeping roofs and high roofs are only sold to specialist dealers trained by us.

TENT BELLOWS VARIANTS

What are the options?

Climagic tent bellows Larger windows, top breathability



This new tent bellows for VW T6.1/T6/T5 short wheelbase consists of a new synthetic material specially developed for this application. This is characterised by improved weather resistance, breathability and durability as well as easier maintenance.

The new tent bellows design with 3 large mosquito windows ensures a particularly airy room experience, best ventilation and plenty of light in the interior. (Windows can be closed by means of an inner cover).

All 3 mosquito nets are zip-on.



OpenSky tent bellows More fresh air and view

For VW T6.1/T6/T5 Easy Fit sleeping roof, front high, short and long wheelbase,

Enjoy the view and plenty of fresh air with the OpenSky tent bellows. Easy to open with the sewn-in zipper and attach to the roof with loops.

NOTE: For your own safety and that of your children, do not sleep with the tent bellows open so no one can fall out. For more information, visit www.reimo.com



Canopies with this symbol are suitable for OpenSky

Conventional tent bellows Living comfort with light and air

The normal tent bellows also offer plenty of light and air through 2 large side windows and a foil window in the front. The side windows are equipped with mosquito nets that can be opened and offer protection from annoying insects. An easy to open blackout is provided by all 3 windows. Below the roof shell is a forced ventilation with mosquito net and provides additional fresh air in the vehicle



ADVANTAGES OF THE REIMO SLEEPING ROOFS

10 decisive advantages, why a Reimo roof is a good decision



Low vehicle height

Your vehicle fits into most standard garages (usual: 2.00 - 2.04 m, please measure)

Simple operation

Easy, almost self-acting raising of the roof, high reliability due to gas pressure springs.

Open Sky tent bellows (optional)

Tent bellows that can be opened with a zip. So you can enjoy the view. Please note the safety instructions at www.reimo.com

Quick-Lock closing system (optional)

Safe and reliable closing without straps and Bowden cables.

Living comfort with light & air

Velour roof lining for the best insulation, feel and moisture balance. 2 large mosquito net windows to open. Windows can be darkened, 1 forced ventilation for 1 foil window. (Equipment varies according to vehicle and roof type)

Legroom

A large, high scissor provides ample legroom in the footwell of the bed. The new stainless steel comfort scissors offer up to 45 cm of legroom.

An additional double bed in the roof

In the additional roof bed a sleeping area of approx. 190-200 cm length and a width of 120-130 cm is created.

Top aerodynamics

Aerodynamic shape for low wind noise and fuel economy.

Insulation and stability through sandwich construction

Roof shell in sandwich construction with integrated insulation and reinforcement for a roof load up to max. 30 kg.



Insulation and stability through sandwich construction

- ① Gelcoat
- ② Glass fibre shell
- ③ laminated inner frame
- ④ Reinforcement material
- ⑤ Glass fibre top layer
- ⑥ Isovelours with lamination



Our roofs are Made in Germany





Open Sky Tent Bellows

Sleep like at home - the new Reimo luxury beds for sleeping roofs AT REIMO LUXURY BECOMES THE NEW STANDARD



Door of the access opening



The luxury beds with spring system for perfect sleeping comfort on the road

The luxury beds have a variety of plastic spring elements and offer you the highest sleeping comfort like at home .

A 40 mm thick mattress ensures the best lying comfort, a fabric panel for the roof access provides a homely look for easy access to the roof bed. Gas springs support the folding up and down of the bed

For Easy Fit sleeping roof for VW T6/T5, Mercedes Vito and Citroën SpaceTourer.

- As a new standard for the Reimo Easy-Fit sleeping roofs for VW, MB Vito and Citroën Spacetourer new luxury beds are available
- A plastic spring system offers the highest comfort and ensures a pleasant sleep
- Comfortable, 40 mm foam mattress



VW CADDY 5 - SLEEPING ROOF

Long wheelbase, year of construction from 2020



NEW
2022

Super-flat sleeping roof for Caddy 5 from model year 2020, rear high

The sleeping roof offers an airy roof bed on the "upper floor" with a sleeping area of approx. 195 x 100 cm and of course the so valuable standing height in the living area, which increases the feeling of space enormously. The at least equally important parking garage suitability is given by an overall height of the vehicle of approx 193 cm

22117136 3149,-

Reinforcing frame

22117R01 519,-

Sleeping roof bed

Sleeping surface approx. 195 x 100 cm, upholstery thickness 4 cm

22124 649,-



VW CADDY MAXI - SLEEPING ROOF

Long wheelbase, year of construction 2008 - 2020



The sleeping roof for the Caddy Maxi up to model year 2020 with long wheelbase transforms your Caddy into a "mini camper" with comfortable standing height. Standing height 170 cm at the front, 205 cm at the rear. Comfortable sleeping roof bed for 2 persons. Sleeping surface approx. 193 x 93 cm, foam thickness 4 cm. The front spoiler ensures good aerodynamics and reduces wind noise. 3 windows in the tent bellows provide fresh air. Vehicle height with sleeping roof approx. 196 cm

2211801 3099,-

Reinforcement frame

22122 519,-

Sleeping roof bed

22123 649,-

Trim frame for all Caddy Maxi up to 05/2015 and Caddy Maxi Kombi from 06/2015 (commercial vehicle, without rear plastic interior trim), 4-piece, Hartfaster uncovered + aluminium profiles

10560 219,-

Trim frame for Caddy Maxi from 06/2015 - 2020 with moulded headliner (passenger car), aluminium profiles only

10561 159,-

Attention: For vehicles with head airbag in the second row of seats the roof mounting is not approved by VW!

THE REIMO

EasyFit sleeping roof

Sleep like on clouds



Decisive advantages of the EasyFit sleeping roof

- The Reimo EasyFit sleeping roof has an extremely flat design and is very aerodynamic
- The GRP roof shell is already provided with integrated insulation during manufacture
- Textile interior lining with foam lamination, - insulating, sound-absorbing and moisture compensating
- The Easy-Up system makes it easier to close the roof and protects the tent bellows
- The separate front spoiler ensures low wind noise even when travelling fast
- Can be installed in approx. 6 hours (without covering roof cut-out)
- Simple and reliable operation due to gas pressure springs
- Standing height with open roof incl. bed approx. 205 cm at the front, 150 cm at the rear (beginning of roof cut-out/beginning of C-pillar)
- Secure roof closure with 2 straps or optional Quick-Lock locking system
- Reinforcement frame is integrated and available in two versions: - Standard for vehicles with hardboard interior trim - Optional for vehicles with moulded headlining/climate headlining
- Various tent bellows options Optional roof bed - Sleeping area approx. 190 cm x 120 cm

The following EasyFit variants are available:

- Configured to your requirements for VW T6.1/T6/T5 short wheelbase, front high, page 119
- VW T6.1/T6/T5 short wheelbase, rear high, page 120
- VW T6.1/T6/T5 long wheelbase, front/rear high, page 120
- Ultraflat for VW T6.1/T6/T5 short wheelbase, front high, page 121
- Citroën Jumpy/Spacetourer and similar, page 131
- Mercedes Vito length 514 cm, front high, page 132
- Renault Trafic, Fiat Talento, Opel Vivaro short wheelbase, front high, page 134

YOUR EASYFIT DREAM SLEEPER ROOF

For VW T6.1/T6/T5 – Short wheelbase – Front high



Tent bellows Climagic in grey



Tent bellows OpenSky in grey

Configure your dream sleeping roof

Our EasyFit sleeping roof is available in numerous variants and is manufactured individually according to your wishes.

You receive the proven Reimo quality with every roof. The installation is carried out with the patented Slider sleeping roof stays in stainless steel for more legroom and comfort installation.

The assembly is done step by step with a configurator



Based on the EasyFit Standard sleeping roof: Shell Standard, Frame Standard, Strap Closure, Tent Bellows Standard Grey - Item No. 21150XXX - 4269,- your selection of the individual components results in the final price.

HOW TO CONFIGURE YOUR INDIVIDUAL EASYFIT SLEEPING ROOF

For VW T6.1 / T6 / T5 with short wheelbase
Item number 21150xxx, basic price 4269.-
(the basic price includes prices of the standard equipment)

1. Select the tray type:

- 1.1 EasyFit Standard shell:** GRP shell with integrated insulation and reinforcement frame
Series 21150XXX 4269,-
- 1.2 Shell EasyFit V-Tec:** The EasyFit V-Tec structure is a GRP sandwich construction of inner and outer shell, light and strong with integrated reinforcements and insulation. The elegant, smooth surface is easy to clean both inside and out
Surcharge 400,-

2. Choose the type of EasyFit frame, suitable for:

- 2.1 van/station wagon vehicles** **Series 0,-**
- 2.2 Vehicles with moulded headlining/climate headlining**
Surcharge 70,-

3. Choose the type of closure:

- 3.1 Belt lock:** Secure and reliable locking with 2 tension belts
Series 0,-
- 3.2 QuickLock lock:** Simple and fast unlocking via the handles similar to a car door lock
Surcharge 390,-
- 3.3 Electrical installation and locking:**
A chain drive with a stainless steel chain opens and closes the roof at the push of a button
Surcharge 1490,-

4. Select the type and colour of the tent beam

- 4.1 Tent bellows standard:** With 2 side windows and mosquito nets (zip-on) and foil front window. All windows with blackout. Forced ventilation with mosquito net at the top of the front.
- 4.1.1. light grey** **Series 0,-**
- 4.1.2. anthracite** **Surcharge 99,-**
- 4.1.3. blue** **Surcharge 99,-**
- 4.1.4. red** **Surcharge 99,-**
- 4.2 Tent bellows Climagic*:** For sun campers. With 3 enlarged windows, each equipped with mosquito netting and blackout. All mosquito nets can be opened.
- 4.2.1 Light grey** **Surcharge 299,-**
- 4.2.2. anthracite** **Surcharge 399,-**
- 4.2.3. blue** **Surcharge 399,-**
- 4.2.4. red** **Surcharge 399,-**
- 4.3 Tent bellows OpenSky*:** Features like the standard bellows. An additional all-round zip opens up the entire front area far into the side, so you are virtually lying outside. Attention, danger of falling: not suitable for small children
- 4.3.1. light grey** **Surcharge 279,-**
- 4.2.2. anthracite** **Surcharge 379,-**
- 4.2.3. blue** **Surcharge 379,-**
- 4.2.4. red** **Surcharge 379,-**

*In extreme weather conditions it may be necessary to close the roof or to use additional climate protection.

5. Special equipment solar module

- 5.1. version standard:** without solar module **Series 0,-**
- 5.2nd version with bonded solar module 120-130W:**
A flexible solar module is bonded to the sleeping roof and the cable is laid up to the Easyfit frame. A suitable charge controller is supplied. Solar panel installed,
Surcharge 999,-

6. Active carrier profile

- 6.1. version standard:** without active carrier profile **Series 0,-**
- 6.2. activecarrier profiles installed:** 4 aluminium profiles, each 400 mm long, are screwed and glued to the sleeping roof shell. This allows the installation of roof racks with a roof load of 30 kg.
Surcharge 369,-

ACCESSORIES (not included in the configuration):

Luxury sleeping roof bed (description page 121)	211530	729,-
Tent bellows insulation (description page 228)	373981	419,-
Climate protection hood (description page 228)	37391	456,90
Roof cover for standard EasyFit frame (description page 120)	10583-2	175,-

ALL INFO AND CONFIGURATOR AT WWW.REIMO.COM

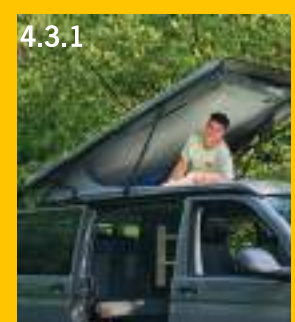
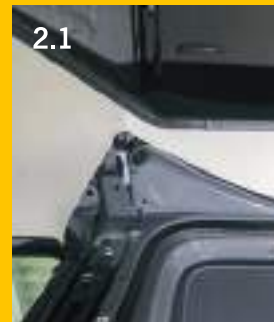

VW T6.1/T6/T5 - SLEEPING ROOF EASYFIT

Long and short wheelbase



Low vehicle height, high everyday utility. Caution: Vehicle heights vary depending on the model. Please measure your vehicle.



EasyFit sleeping roofs for VW Transporter short wheelbase, pre-assembled

Standing height (roof open) approx. 205-150 cm. 3-part sleeping roof, integrated GFK reinforcement frame, total weight approx. 60 kg. Also for vehicles with airbag in the passenger compartment. Colour white

KR, rear high, with belt fastener 2115003 4429,-

Matching sleeping roof bed for EasyFit sleeping roof

Sleeping roof bed in grey laminate. Pre-assembled, gas spring supported. Sleeping surface approx. 125 x 191 cm. Cushion dimensions approx. 107 x 184 x 4 cm,

3 cm thick. Cover 100% polyester, removable and cleanable

KR, rear high 21156 599,20

EasyFit roof lining for all Easy Fit sleeping roofs, not for climate roofs!

(For climate roofs the original roof lining is used again)

For covering the roof cut-out/roof lining in the living area, 3 mm hardboard, raw (uncoated).

Short wheelbase 10583-2 175,-

EasyFit sleeping roofs for VW Transporter long wheelbase, pre-assembled



Standing height (roof open) approx. 205-150 cm. 3-part sleeping roof, integrated GFK reinforcement frame, total weight approx. 70 kg. Also for vehicles with airbag in the passenger compartment. Colour white

LR, front high, with belt fastener 2116201* 4589,-

LR, front high, with Quick-Lock locking system 2116202* 4999,-

LR, rear high, with belt lock 2116203 4789,-

EasyFit roof front high, pre-assembled, climate sky version Same as roof listed above, but for vehicles with climate sky. Colour white

LR, with belt buckle 2116201C* 4779,-

LR, with Quick-Lock locking system 2116202C * 4999,-

Open Sky Tent Bellows

Zippered opening bellows. Suitable for Easy Fit sleeping roofs VW T5/T6 KR front high

LR, extra charge 2929980 260,-

Suitable sleeping roof beds for EasyFit sleeping roofs

Sleeping roof bed laminate grey. Pre-assembled, gas spring supported. Sleeping surface approx. 126 x 209 cm. Cushion dimensions approx. 107 x 200x4 cm,

Cover 100% polyester, removable and cleanable

LR, rear high 21158 659,-

LUXURY sleeping roof bed, including disc spring system

Plate spring system for increased sleeping comfort, ventilated from below. Sleeping surface approx. 132 x 197 cm, comfort cushion approx. 108 x 200x4 cm. A panel covers the access opening during travel.

LR, front high 211670 854,43

EasyFit roof lining (not for climate headlining!)

(With climate headlining the original roof lining is used again)

To cover the roof cut-out/roof lining in the living area, 3 mm hardboard, raw (uncoated).

Long wheelbase 105843 175,-

Freight flat rate sleeping roof: For delivery within Germany or collection from specialist dealer 225 104,-

* Open Sky only possible for models marked with *.

VW T6.1/T6/T5 - EASYFIT ULTRAFLAT ROOF

Short wheelbase



ULTRAFLACH EASYFIT sleeping roof Vehicle height under 2 m

- **New, 30 mm flatter design compared to the common EasyFit design**
- **The overall height of most T6 base vehicles of 2 m is not exceeded**
- **New Easy-Up mechanism makes it easier to open and close the roof**
- **The higher comfort scissors also provide 10 cm more legroom (compared to the EasyFit design)**
- **Rear seat height for persons up to 170 cm tall (in combination with luxury bed 211530)**



EasyFit Ultraflat sleeping roofs for VW Transporter T6.1/T6/T5 short wheelbase, pre-assembled

Standing height (roof open) approx. 205-150 cm, 3-part sleeping roof, integrated GFK reinforcement frame, total weight approx. 60 kg. Colour white
KR, front high, with belt fastener 2806401 4365,-

Optionally available:
Open Sky tent bellows, extra charge 2929981 199,-

Matching sleeping roof beds for EasyFit Ultraflat sleeping roof

Sleeping Roof Bed Standard Grey. Pre-assembled, gas spring supported
 Sleeping surface approx. 198x123 cm. Cushion dimensions approx. 183 x 109x3 cm. Cover 100% polyester, removable and cleanable
KR, front high 28064B 639,-

Luxury sleeping roof bed with spring system

A large number of plastic spring elements provide increased sleeping comfort High lying comfort due to 40 mm thick mattress. No suitable cover for ice opening.
 Sleeping surface approx. 198 x 123 cm. Cushion dimensions approx. 185 x 108 x 4 cm.

KR, front high 211530 729,-

Flat-rate freight for sleeping roof: For delivery within Germany or collection from specialist dealer
 225 104,-



SLEEPING ROOF SUPER FLAT - VW T6.1/T6/T5

Long and short wheelbase



Extra stable scissor mechanism



Aerodynamic spoiler (long wheelbase)



2 side mosquito net windows

Superflat Transporter Long Wheelbase, Front High



With parts certificate*. 2-piece. Gas spring supported. Good ventilation through 3 windows that can be closed from the inside with tent fabric (2 side windows with removable mosquito net insert, front window foil).

Vehicle elevation only approx. 6 cm. Tent bellows: 100% cotton.

Colour white **21085 3335,-**

Installation frame Transporter long wheelbase

Required for above sleeping roof. Roof cutout incl. driver's cab.

	Left-hand drive	21081 608,83		righthanddrive	21081R 599,-
--	-----------------	---------------------	--	----------------	---------------------

Sleepingroof bed Transporter long wheelbase

Sleeping surface approx. 210 x 120 cm. Upholstery dimensions approx. 182 x 110 x 3 cm thick.

Colour grey. **21082 619,-**

Superflat Volkswagen Transporter short wheelbase, front high



With parts certificate*. Gas spring supported. Vehicle elevation approx. 7 cm. Tent bellows 100% cotton, breathable. Good ventilation through 3 windows which can be closed from the inside with tent fabric (2 side windows with removable mosquito net insert, foil front window). Standing height (roof open) approx. 195 - 245 cm. Vehicle height with roof approx. 200 cm (depending on design and load).

Colour white **210960 2889,-**

① **Installation frame Volkswagen Transporter KR from 2003** required for above sleeping roof. Roof cutout incl. driver's cab

	Left-hand drive	21093 469,-		righthanddrive	21093R 469,-
--	-----------------	--------------------	--	----------------	---------------------

Sleeping roof bed Volkswagen Transporter KR from 2003 Grey, wooden top 2-piece incl. foam and cover grey, 100% polyester. The divided sleeping roof bed guarantees high freedom of movement in living position. Sleeping surface approx. 200 x 120 cm. Upholstery dimensions approx. 182 x 110 x 3 cm thick **21097 599,-**

Folding bed for sleeping roof Volkswagen Transporter KR Multivan with Klimatronic. Graffiti laminate.

Only suitable for installation frame 210931. 3-piece wooden panel incl. foam and grey cover, 100% polyester. Sleeping surface approx. 210x120 cm. Mattress approx. 4 cm thick. Incl. material to convert a Multivan with Klimatronic and GPS. Light grey laminate. **21099 719,-**

Mounting frame for Multivan with Klimatronic **210931 489,-**

Superflat Transporter Long Wheelbase, Rear High



With parts certificate*. Like sleeping roof 21085, but roof position rear high. Colour white **21075 3439,-**

Installation frame Transporter long wheelbase

required for above sleeping roof. Roof cutout incl. driver's cab

	Left hand drive	21081 608,83		righthanddrive	21081R 599,-
--	-----------------	---------------------	--	----------------	---------------------

Sleeping roof bed Transporter long wheelbase

Sleeping surface approx. 210 x 120 cm. Upholstery dimensions approx. 200 x 110 x 4 cm thick

Colour grey. **21076 639,-**

Superflat Volkswagen Transporter short wheelbase, rear high



With parts certificate*. Gas spring supported. Vehicle elevation approx. 7 cm. Tent bellows 100% cotton, breathable. Good ventilation through 3 windows which can be closed from the inside with tent fabric (2 side windows with removable mosquito net insert, foil front window). Standing height (roof open) approx. 195 - 245 cm. Vehicle height with roof approx. 200 cm (depending on design and load). Colour white **21069 3199,-**

① **Installation frame Volkswagen Transporter KR from 2003** required for above sleeping roof. Roof cutout incl. driver's cab

	Left-hand drive	21093 469,-		righthanddrive	21093R 469,-
--	-----------------	--------------------	--	----------------	---------------------

Sleeping roof bed Volkswagen Transporter KR, from 2003, wooden top grey incl. foam and cover grey, 100% polyester. Sleeping surface approx. 200 x 120 cm. Upholstery dimensions approx. 200 x 110 x 3 cm thick. **21070 639,-**

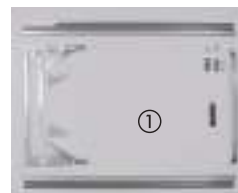

Flat-rate freight for sleeping roof: For delivery within Germany or collection from specialist dealer

225 104,-

*only valid with our offered installation frames. Standard colour of the roofs white, illustrations partly show additional equipment. For an additional charge, we will also be happy to paint your vehicle roof in the colour of your choice.



POP UP ROOFS - VW T6.1/T6/T5

Long and short wheelbase

POP UP ROOF EASYFIT ULTRAFLAT

For Volkswagen Transporter T6

- The new lifting roof with EasyFit subframe
- Raising the vehicle by only 5 cm
- Less noise at higher speeds thanks to integrated front spoiler

The EasyFit sub-frame allows perfect adaptation to the roof structure of the vehicle. The roof offers standing height in an area of 98 x 92 cm. 3 closable tent fabric windows with mosquito net insert Tent bellows grey, 100% cotton.

Suitable for VW T6 between B-pillar and C-pillar. Roof elevation approx. 5 cm, extended standing height 5 cm with closed roof and 50 cm with open roof. Roof cutout W 100 x L 95 cm

2118501 2629,-



POP UP ROOF SUPERFLAT-VW T6.1/T6/T5

Long and short wheelbase

For Volkswagen Transporter T6/T5, short or long wheelbase, from year of manufacture 2003. Parallel and gas spring supported gas spring assisted. Interior elevation approx. 45 cm
 3 closable tent fabric windows with mosquito net insert
 Tent bellows grey, 100% cotton
 Roof cut-out approx. L106 x W101 cm
 Vehicle elevation approx. 7 cm
 Roof dimensions approx. L170 x B130 x H11 cm.
 Weight approx. 37 kg
 Roof shell colour white (R9002).
 With parts certificate*

21185 1649,-

*only valid with our offered installation frames
Standard colour of the roofs white, illustrations partly show additional equipment. For an additional charge, we will also be happy to paint your vehicle roof in the colour of your choice.

Flat-rate freight charge for pop up roof: For delivery within Germany or collection from specialist dealer

227 53,40



VW T6.1/T6/T5 - HIGH ROOF SPORTLINE

Short wheelbase, from year of manufacture 2003



Sporty and aerodynamic. With parts certificate*, standing height approx. 185 cm. Van character. Roof dimensions approx. L293 x W153 x H56 cm. Vehicle height approx. 45 cm. Bed not useful.

Colour white **21090** **1469,-**
Interior trim **21060** **1089,-**

Installation frame Volkswagen Transporter from 2003

TÜV approved. Available with or without cab cut-out:

With cab cutout

Advantage: headroom in the driver's cab, easy "walking to the rear"

Roof cut-out approx. 280 x 110 cm.

Not possible with Sunroof in the driver's cab.

 Left-hand drive **21093** **469,-**  righthanddrive **21093R** **469,-**

Without cab cutout

Advantage: Storage space above cab. Storage compartment possible

(not for sleeping roof) Roof cut-out approx. 240 x 110 cm.

 Left-hand drive **21094** **399,-**  righthanddrive **21094R** **399,-**



VW T6.1/T6/T5- HIGH ROOF ERGOLINE

Short or long wheelbase, from 2003 onwards



Ergoline high roof for short wheelbase, with parts certificate*

Classic, smooth roof shape. Vehicle height approx. 73 cm

Standing height approx. 208 cm. Colour white **21048** **1499,-**

Interior lining

20 mm insulation material with grey Isovelours **21049** **1089,-**

Installation frame Volkswagen Transporter KR

With cab cut-out. TÜV incl., bed support integrated, with cab cut-out (roof cut-out approx. 280 x 110 cm). Advantage: headroom in the driver's cab, easy "walking to the rear". Not with Sunroof in the driver's cab.

 Left-hand drive **21093** **469,-**  righthanddrive **21093R** **469,-**

Without cab cut-out (roof cut-out: approx. 203x113 cm)

Advantage: Storage space above driver's cab. Storage compartment possible (not for sleeping roof)

Especially for vehicles with Klimatronic **210931** **489,-**

High roof bed Volkswagen Transporter KR

Grey wooden panel incl. foam mattress approx. 6 cm thick and grey cover, 100% polyester. Sleeping surface approx. 190 x 110 cm **21089** **619,-**

Flat-rate freight charge for high roof: For delivery within Germany or collection from specialist dealer **226** **203,-**

Ergoline high roof for long wheelbase

With parts certificate*. High roof bed possible. Standing height approx. 205 cm. Classic roof shape. Smooth exterior shape. Vehicle height: approx. 65 cm. Side and rear windows: max. 70 x 30 cm. Sunroof possible.

Colour white **21058** **1599,-**

Interior trim

Cosy ambience, velour grey. Cladding and insulation (20 mm) in one. Complete incl. mounting material **21059** **1199,-**

Installation frame with cab cut-out for Transporter LR from 2003 onwards

Advantage: headroom in the driver's cab, easy "walking to the rear" Integrated bed support. Not with Sunroof in the driver's cab.

 Left-hand drive **21081** **608,83**  righthanddrive **21081R** **599,-**

Mounting frame without cab cutout for Transporter LR from 2003 onwards

 Left-hand drive **21084** **469,73**  righthanddrive **21084R** **469,73**

High roof bed Volkswagen Transporter LR

Wooden plate apple incl. foam mattress, approx. 6 cm thick and cover grey, 100% polyester. Sleeping surface approx. 210 x 120 cm

18058 **723,47**

*only valid with our offered installation frames. Standard colour of the roofs white, illustrations partly show additional equipment. For an additional charge, we will also be happy to paint your vehicle roof in the colour of your choice. Windows and roof hoods installed in the high roofs and shown are not included in the scope of delivery.



VW T4 - SUPER FLAT SLEEPING ROOF

Short wheelbase, until year of construction 2003, front high

Pre-assembled, with assembly material and assembly instructions (without bed and installation frame). With parts certificate*. Standing height with open roof approx. 195 - 245 cm. Vehicle height with roof approx. 200 cm (depending on design and load). Sleeping area approx. 108 x 195 cm. 2 side windows in the tent bellows with mosquito netting, 1 foil window integrated in the front. Bellows 100% cotton.

Roof shell colour white **21115 2899,-**

Matching bed for super flat sleeping roof

Lightweight poplar plywood, three sections, 2-fold folding, padding thickness 40 mm, incl. removable cover (100% polyester)

Sleeping surface: 187x108 cm, colour grey **21113 499,-**

Bed with gas spring support Lightweight 15 mm poplar plywood, 3 parts, each with 2 gas dampers and support struts. 40 mm foam with removable polyester cover. Sleeping surface: 187x108 cm, colour grey **21111 599,-**

Necessary for body reinforcement:

Installation frame VW Transporter until 2003, short wheelbase

Mounting frame parts incl. rivets, glue, building instructions. Roof cutout incl. driver's cab.

Left hand drive **21003 519,-**

righthanddrive **21003R 519,-**



Freight flat rate sleeping roof: For delivery within Germany or collection from specialist dealer **225 104,-**



VW T4 - SUPER FLAT SLEEPING ROOF

Long wheelbase, until year of construction 2003



Gas spring assisted roof installation front high. With parts certificate*. Standing height with open roof approx. 195 - 245 cm. Vehicle elevation approx. 6 cm. Integrated rain gutter. 3 windows in the tent bellows (1 with foil), mosquito net with zip. Sleeping surface approx. 200 x 120 cm. Bellows 100% cotton. Cover 100% polyester. Sliding glass roof and solar cell possible. Concealed mounting of the active rail possible without additional vehicle elevation. Roof shell colour white. **21121 2899,-**

Installation frame for sleeping roof super flat

Roof cutout incl. roof cutout for sleeping roof

Left-hand drive **21023 559,-**

righthanddrive **21023R 559,-**

Sleeping roof bed Superflat

Wooden 2-part bed (grey laminated board), incl. foam and cover. The two-part bed guarantees high freedom of movement in living position. Sleeping surface approx. 197x108 cm. Foam mattress 4 cm.

21112 599,-

Freight flat rate for sleeping roof: For delivery within Germany or collection from specialist dealer **225 104,-**



VW T4 - SLEEPING ROOF EASYFIT

Short wheelbase, until year of construction 2003, front high

Vehicle increase by approx. 6 cm, roof cutout incl. driver's cab
Tent bellows 100% cotton. Roof shell colour white. Suitable for right or left-hand drive.

Scope of delivery: sleeping roof with tent bellows and lower frame (without bed).

21140S 3399,-

Suitable bed for Easy Fit sleeping roof front high

Scope of delivery: Bed for Easy Fit sleeping roof with foam and cover (100% polyester)



21140B 729,-





VW T4 - POP UP ROOF SUPER FLAT

Short or long wheelbase, until year of construction 2003



Standing height in the entrance area (with open roof) approx. 190 cm
Roof installation with gas spring support. 2 side windows with mosquito netting, 1 foil window integrated in the front. Incl. installation frame. Vehicle elevation approx. 6 cm.

Roof dimensions approx.: L175 x B130 x H9 cm

Roof cut-out approx. L107,5 x W101 cm. Tent bellows 100% cotton

Lifting roof position between B and C pillars. Roof shell colour white.

Incl. parts certificate*.

(Delivery time approx. 4-6 weeks)

21210

1599,-

Flat-rate freight charge for lifting roof: For delivery within Germany or collection from specialist dealer

227

53,40



VW T4 - HIGH ROOF ERGOLINE

Short or long wheelbase, until year of construction 2003



Ergoline high roof for short wheelbase

Classic, smooth exterior roof shape. Roof dimensions approx. L297 x B149 x H74 cm. Vehicle height approx. 63 cm. Standing height approx. 205 cm. Side windows max. 70 x 30 cm, rear windows max. 70 x 40 cm. High roof bed possible. With parts certificate*, roof shell colour white

21040 1399,-

Velours interior trim Cosyambience, velours grey. Panelling and insulation (20 mm) in one. Complete incl. mounting material

21041 1199,-

Sleeping roof bed Wooden board in 2 parts (laminated board grey), incl. foam and cover. The two-part bed guarantees a high degree of freedom of movement in the living position. Sleeping surface approx. 197x108 cm. Foam mattress 4 cm.

21112 599,-

Further suitable accessories: Small sliding roof hatch or glass lifting roof possible (see www.reimo.com)

Ergoline high roof for long wheelbase

Classic, smooth exterior roof shape. Roof dimensions approx. L335 x B149 x H74 cm. Vehicle height approx. 63 cm. Standing height approx. 205 cm. Side windows max. 70 x 30 cm, rear windows max. 70 x 40 cm. Raised roof bed possible. With parts certificate*

Roof shell colour white

21050

1599,-

Velours interior trim

Cosy ambience, velour grey. Cladding and insulation (20 mm) in one. Complete incl. mounting material

21051

1199,-

*only valid with our offered installation frames. Standard colour of the roofs white, illustrations partly show additional equipment. For an additional charge we can also paint your vehicle roof in the colour of your choice. Windows and roof hoods installed in the high roofs and shown are not included in the scope of delivery.



VW T4 - HIGH ROOF AEROLINE

Short or long wheelbase, until year of construction 2003



Aeroline high roof for short wheelbase

Elegant roof shape. With parts certificate*. Roof dimensions approx. L297 x B149 x D75 cm. Vehicle height approx. 64 cm. Standing height approx. 210 cm. Side and rear windows max. 70 x 30 cm. Sleeping surface approx. 185x115 cm, foam thickness 3 cm. Option: concealed active carrier system and sliding roof hatch possible. Roof colour white

21005 1699,-

Matching accessories: active rail 2 m **41300 41,20**

Inner shell for Aeroline 20 mm insulation possible. **21006 1099,-**

Interior panelling set for Aeroline for gluing in

Prefabricated panelling elements for the high roof. 20 mm insulation material, covered with grey Isovelours **21008 1089,-**

Sleeping roof bed

Wooden board in 2 parts (laminated board grey), incl. foam and cover. The two-part bed guarantees a high degree of freedom of movement in the living position. Sleeping surface approx. 197x108 cm. Foam mattress 4 cm.

21112 599,-

Aeroline high roof for long wheelbase

Elegant roof shape. Roof dimensions approx. L335 x B149 x D85 cm. Vehicle height approx. 74 cm. Standing height approx. 210 cm. Side and rear windows max. 70 x 30 cm. Option: concealed active carrier system and sliding roof hatch 52 x 54 cm possible. With parts certificate*.

Roof colour white **21010 1599,-**

Active carrier system, 1 rail, length 2 m **41300 41,20**

REIMO INSTALLATION FRAMEWORK (short or long wheelbase)

TÜV-tested - Integrated bed support - With or without cab cut-out

① Installation frame with cab cutout

Roof cutout approx. 284 x 110 cm

	Left-hand drive		
	short wheelbase	21003	519,-
	long wheelbase	21023	559,-
	righthanddrive		
	short wheel	21003R	519,-
	long wheelbase	21023R	559,-



② Installation frame without cab cutout

(not for sleeping roof). Roof cut-out approx. 243 x 110 cm

	Left-hand drive		
	short wheelbase	21004	409,-
	long wheelbase	21022	399,-
	righthanddrive		
	short wheel	21004R	437,63
	long wheelbase	21022R	429,-



*only valid with our offered installation frames. Standard colour of the roofs white, illustrations partly show additional equipment. For an additional charge we can also paint your vehicle roof in the colour of your choice. Windows and roof hoods installed in the high roofs and shown are not included in the scope of delivery.



VW T3 - SLEEPING ROOF SUPER FLAT

Short wheelbase, year of construction 1980 to 1990



Completely pre-assembled, roof installation at the front high. Vehicle height with roof is approx. 2 m. Supplied without sleeping roof bed, foam and cover. Vehicle height: approx. 11 cm. Standing height with roof open approx. 200 - 240 cm. Roof cut-out: approx. 109 x 103 cm. With parts certificate*.

Roof shell colour white, smooth surface **20136** **2799,-**

Luggage tray for sleeping roof

Forms a harmonious roof closure at the front and offers additional storage space. The trough can be used to stow a stuff sack, for example.

Colour: White, smooth surface **20137** **479,-**

Canopy bed - Bed area: approx. 185 x 112 cm

With foam (approx. 3 cm thick) and cover (100% polyester) in Classic grey.

20121 **629,-**

Freight flat rate for sleeping roof: For delivery within Germany or collection from specialist dealer

225 **104,-**



VW T3 - HIGH ROOF AEROLINE

Short wheelbase, until year of construction 1990



Aerodynamic shape, high quality, proven for years. Roof dimensions approx. L344 x W142 x H77 cm. Vehicle height approx. 64 cm. Standing height approx. 202 cm. Rear windows approx. 70 x 40 cm, side windows approx. 60 x 18 cm. Sliding roof hatch approx. 52 x 54 cm. With parts certificate*. Colour: White

20000 **1599,-**

Installation frame for Aeroline roof

Wooden frame for roof cut-out L110 x W104 cm

29440 **80,20**

Flat-rate freight charge for high roof: For delivery within Germany or collection from the dealer you will receive on request



VW T3 - LIFTING ROOF SUPER FLAT

Until year of construction 1990



The inexpensive alternative. Standing height in the sliding door area. Simple and quick installation. Roof dimensions approx. L161 x W128 x H11 cm. Vehicle height approx. 5 cm. Standing height with open roof: interior plus approx. 45 cm. Roof cut-out LxW: approx. L110 x W104 cm. Tent bellows 100% cotton. Incl. wooden installation frame, cladding profile for cut-out and small parts. With parts certificate*.

Roof shell colour white **20200** **1499,-**

Flat-rate freight charge for lifting roof: For delivery within Germany or collection from dealer

227 **53,40**

*only valid with our offered installation frames. Standard colour of the roofs white, illustrations partly show additional equipment. For an additional charge we can also paint your vehicle roof in the colour of your choice. Windows and roof hoods installed in the roofs and shown are not included in the scope of delivery.



TOYOTA HIACE - EASYFIT SLEEPING ROOF

For Toyota Hiace from 2016, only Asia and Australia

Gas lift assisted, roof installation front high. With front and 2 side windows. Side windows with mosquito nets. Canopy (100% polyester), grey tent bel-lows (100% cotton). Roof shell colour white.

With GFK mounting frame and separate front spoiler front high
2806301 4099,-

Sleeping roof bed

15 mm wooden panel (high freedom of movement in living position).
Sleeping surface approx. 175 x 110 cm
With 4 cm thick foam and grey cover (100% polyester)
Incl. bed pads
28073 631,30

Flat-rate freight for sleeping roof: For delivery within Germany
or collection from specialist dealer
225 104,-



HYUNDAI H1 - SLEEPING ROOF SUPER FLAT

Short wheelbase, from year of manufacture. 2008

For Hyundai H1 7 1800 from year of manufacture 2008
2-piece sleeping roof with separate front spoiler . Roof position high at the front. Vehicle height including roof approx. 198 cm. Without parts certi-ficate. Roof shell colour quartz grey
26170 3499,-

Installation frame for super flat sleeping roof
including cab cutout
26174 726,53

Sleeping roof bed for Superflach sleeping roof
Grey laminate, sleeping surface approx. 200 x 120 cm. Foam mat
approx. 190 x 101 x 4 cm.
26175 555,33

Flat-rate freight charge for sleeping roof: For delivery within Germany
or collection from specialist dealer
225 104,-



*only valid with our offered installation frames. Standard colour of the roofs white, illustrations partly show additional equipment. For an additional charge we can also paint Your vehicle roof in the colour of your choice. Windows and roof hoods installed in the high roofs and shown are not included in the scope of delivery.



FORD TRANSIT - SUPER FLAT SLEEPING ROOF

Short wheelbase, from year of construction 07/2013



Roof pitching high at the front. 3 windows in the tent bellows, removable mosquito nets. Bellows 100% cotton. Bed dimensions: approx. 203 x 130 cm. Standing height with open roof: 205 cm front, 150 cm rear. Bellows mounted. Without frame, without bed. Separately available mounting frame required for reinforcement. Individual approval required.

Without cab cut-out	22115	3599,-
With cab cutout	221150	3599,-

Sleeping roof bed, front high, for sleeping roof without cab cutout	22116B	599,-
for sleeping roof with cab cutout	22115B	689,-

Installation frame without cab cut-out, front high	20113	1399,-
with cab cutout, front high	20114	1499,-

A manufacturer's approval is available for the roof.

Freight flat rate sleeping roof: For delivery within Germany or collection from dealer	225	104,-
---	-----	-------



FIAT SCUDO - SLEEPING ROOF SUPER FLAT

Long wheelbase, year of construction 2006 to 2016



Sleeping roof high at the front. Vehicle height approx. 200 cm. Sleeping roof with front section, roof shell in gelcoat. In the front a large window (can be used as emergency exit). At the side 2 smaller windows with mosquito net. Without parts certificate. Individual approval required.

Roof shell colour white	28140	3499,-
Installation frame set with cab cut-out	28141	559,-

Sleeping roof bed Sleeping surface 200 x 120 cm. Made of 15 mm poplar plywood (light) in light-grey grey laminate. 1-piece and gas spring supported. Mattress in 3 cm foam with grey cover (100% polyester), can be cleaned	28142	649,-
--	-------	-------

Flat-rate freight charge for sleeping roof: For delivery within Germany or collection from specialist dealer	225	104,-
---	-----	-------



FIAT TALENTO (from 8/2014) - SLEEPING ROOF EASYFIT

For Opel Vivaro B (until 3/2019)/Renault Trafic, Nissan NV300, short wheelbase



Gas lift assisted, roof mounted high at the front. Front spoiler included. Vehicle height including sleeping roof approx. 207 cm. With front and 2 side windows. Front can be opened with zipper. Side windows with mosquito nets. Canopy (100% polyester), grey tent bellows (100% cotton). Standing height 225 cm at the front, 140 cm at the rear. Including installation frame and parts certificate*. Roof shell colour white

Strap closure	2806011	5299,-
Safety lock	2806012	5599,-

Sleeping roof bed Sleeping surface 187 x 130 cm, including cushion	28071	699,-
--	-------	-------

LUXURY sleeping roof bed, including disc spring system Discspring system for increased sleeping comfort, ventilated from below. Sleeping surface approx. 190 x 140 cm, cushion dimensions approx. 186 x 130 x 4 cm. Cover for entrance opening not suitable for LR	280720	749,-
---	--------	-------

Freight flat rate for sleeping roof: For delivery within Germany or collection from specialist dealer	225	104,-
--	-----	-------

*only valid with our offered installation frames. Standard colour of the roofs white, illustrations partly show additional equipment. For an additional charge we can also paint your vehicle roof in the colour of your choice. Windows and roof hoods installed in the roofs and shown are not included in the scope of delivery.

CITROEN BERLINGO - EASYFIT SLEEPING ROOF

For Citroën Berlingo and similar vehicles

- Create with the Reimo EasyFit sleeping roof additional sleeping places in your Mini-Camper
- Standing height in the living area with the roof open (heights approx. 205-170 cm)
- Approx. 45 cm of legroom in the roof bed due to the higher comfort scissors
- The newly developed Easy-Up mechanism facilitates the setting up and closing of the roof
- Excellent ventilation and a great view through closable window openings in the tent bellows, with mosquito netting at the sides and foil windows at the back with foil window
- Integrated GRP reinforcement frame
- Vehicle height with sleeping roof approx. 198 cm



The EasyFit sleeping roof fits the following vehicles: Citroen Berlingo III, Peugeot Partner III / Rifter, Opel Combo E, Toyota ProAce City (from model year 2018, wheelbase 2975 mm, body length 4753 mm)

28051136 4199,-

Matching sleeping roof bed with multi-part mattress:

Sleeping surface approx. 196 x 105 cm, upholstery dimensions approx. 190 x 100

Upholstery thickness: 4 cm (in the transition area to the vehicle 5 cm)

28051B03 694,43



CITROËN JUMPY - EASYFIT SLEEPING ROOF

For Citroën Jumpy/Spacetourer, Peugeot Expert Traveller, Toyota Pro Ace - L2 from year of construction 2016, Opel Zafira D Life (length 496 cm)/Opel Vivaro (both from autumn 2019)

Sleeping roof in EasyFit design with separate front spoiler. Total height with sleeping roof 1.98 m. Equipped with the new Slider sleeping roof stays for more legroom and Easy-up system, including reinforcement frame. For vehicle length L2 4950 mm

For Jumpy with standard canopy, incl. belt fastener, front high, With parts certificate **2806501 4699,-**

Sleeping roof for Spacetourer (with comfort headliner) front high **2806501C 4899,-**

Sleepingroof bed LUXURY, including plastic spring system

Many spring elements provide increased sleeping comfort, ventilated from below. Pre-assembled and gas spring supported. Sleeping surface approx. 198 x 120. Upholstery dimensions approx. 186 x 109 x 4 cm, cover 100% polyester, removable and cleanable

280680 729,-



With adjustment work also on L3 vehicles (length 5310 mm) mountable. (without parts certificate)



*only valid with our offered installation frames. Standard colour of the roofs white, illustrations partly show additional equipment. For an additional charge we can also paint Your vehicle roof in the colour of your choice. Windows and roof hoods installed in the high roofs and shown are not included in the scope of delivery.



MERCEDES VS20 - EASYFIT SLEEPING ROOF

For Vito, V-Class, Metris, Valente, V-Class, long from 8/2014, body length 514 cm

Approx. 10 cm more
Legroom due to new
comfort scissors

Easy-Up function for
easy
opening and closing



Gas spring assisted roof mounting front high. Ready pre-assembled, incl. front spoiler. 2 side windows (mosquito net removable), 1 foil window integrated in the front. Vehicle height incl. roof approx. 197 cm. Headroom approx. 170 - 222 cm. Tent bellows 100% cotton. Roof shell colour white. **Incl. parts certificate**

EasyFit sleeping roof front high, with belt fastener For vehicles without air-conditioning canopy	2316003	4499,-
For vehicles with air-conditioned head	2316003C	4499,-
Open Sky canopy, surcharge	2929982	279,-

LUXURY sleeping roof bed, including plastic spring system

Plate spring system for increased sleeping comfort, ventilated from below. 4 cm comfort padding, sleeping surface 200 x 120 cm. Cover 100% polyester, removable and cleanable

23162 **729,-**



MERCEDES VITO - SUPER FLAT SLEEPING ROOF

For Mercedes Benz Vito/Viano compact/long/extra long, built from 2004 (also built from 2015)



Vito/Viano compact

Roof installation front high. Vehicle length 4748 mm. 2 side windows (mosquito net removable), 1 foil window integrated in the front. Vehicle elevation approx. 7 cm. Tent bellows 100% cotton. With parts certificate*.

Roof shell colour white **23140** **3099,-**

Sleeping roof bed

15 mm poplar plywood in grey, laminate. Foam 6 cm and cover grey. 100% polyester. Sleeping surface approx. 200 x 120 cm

23141 **759,70**

Installation frame

incl. cab cut-out. Cut-out size approx. 210 x 105 cm. The last 50 cm of the original sheet metal roof remain for the roof hanging cabinet admission.

23132 **533,93**



Vito/Viano long

Identical with Schlfadach compact

Vehicle length 4993 mm. **23130** **3199,-**

Sleeping roof bed

15 mm poplar plywood in grey, laminate. Foam 6 cm and cover grey 100% polyester, tent bellows 100% cotton
Sleeping surface approx. 200 x 120 cm

23131 **759,70**

Installation frame

incl. cab cut-out. Cut-out size approx. 210 x 105 cm. The last 50 cm of the original sheet metal roof remain for the roof hanging cabinet admission

23132 **533,93**



Vito/Viano extra long (from MY 8/2014)

Identical with sleeping roof compact

Vehicle length 5223 mm. **23150** **3299,-**

Sleeping roof bed

15 mm poplar plywood in grey, laminate. Foam 6 cm and cover grey 100% polyester, tent bellows 100% cotton. Sleeping surface approx. 200 x 120 cm

23151 **759,70**

Installation frame incl. cab cut-out. Cut-out dimensions approx. 210 x 105 cm. The last 50 cm of the original sheet metal roof remain for the overhead cupboard admission.

23132 **533,93**

Flat-rate freight charge for sleeping roofs: For delivery within Germany or collection from specialist dealer

225 **103,99**

*only valid with our offered installation frames. Standard colour of the roofs white, illustrations partly show additional equipment. For an additional charge, we will also be happy to paint your vehicle roof in the colour of your choice



MERCEDES VITO - SUPER FLAT SLEEPING ROOF

Until year of construction 2003

Super flat sleeping roof for Mercedes Benz Vito up to year of construction 2003. Roof installation front high. 2 side windows (mosquito nets removable). Vehicle height approx. 11.5 cm. Vehicle height with roof approx. 198 cm. Standing height (roof open) approx. 185 - 230 cm. Tent bellows 100% cotton. With parts certificate*.

Roof shell colour white **Front high** 23115 3273,13

Sleeping roof bed with foam and cover grey 100% polyester. Sleeping surface approx. 200x120 cm **Front high** 23116 587,43

Installation frame incl. cab cut-out **Front high** 23117 555,33

Freight flat rate sleeping roof: For delivery within Germany or collection from specialist dealer 225 104,-



MERCEDES VITO - ERGOLINE HIGH ROOF

And Viano built from 2004 (also suitable built from 2015)

Vehicle length 4993 mm. Classic, smooth roof shape. Glass fibre reinforced plastic shell. Vehicle elevation approx. 65 cm. Bed installation possible. With parts certificate*. Roof shell colour white 23125 1899,-

Interior trim set Vito/Viano 23127 1099,-

Installation frame incl. cab cut-out. Cut-out dimensions approx. 210 x 105 cm. The last 50 cm of the original sheet metal roof are retained for the overhead locker. 23132 533,93

High roof bed for Ergoline high roof 23128 866,70



MERCEDES SPRINTER - ERGOLINE HIGH ROOF

And VW Crafter from 2006 / medium wheelbase

Standing height in the roof approx. 232 cm. Classic, smooth roof shape. Glass fibre reinforced plastic shell. Vehicle elevation approx. 66 cm. Bed installation possible. Without parts certificate*. Dimensions approx. 403 x 164 x 75 cm. Roof shell colour white 23092 2299,-

Interior trim set Crafter/Sprinter 23046 1199,-

Installation frame without cab cut-out. Cut-out dimensions approx. 293 x 146 cm 23094 416,23

High roof bed for Ergoline high roof 23047 694,43

Flat-rate freight charge for high roofs: For shipment within Germany or collection from the specialist dealer is available on request.



*only valid with our offered installation frames. Standard colour of the roofs white, illustrations partly show additional equipment. For an additional charge we can also paint your vehicle roof in the colour of your choice. Windows and roof hoods installed in the high roofs and shown are not included in the scope of delivery.

RENAULT TRAFIC KR - SLEEPING ROOF EASYFIT V-Tec

For Opel Vivaro B (until Bj. 3/2019)/Trafic, Nissan NV300, Fiat Talento short wheelbase (from Bj. 8/2014)



The new EasyFit V-Tec sleeping roof is a sandwich construction of inner and outer shell. Inner and outer shell, light and strong with integrated reinforcements. The safety lock is screwed through the shell. Elegant smooth surface inside and outside, easy to clean. Incl. installation frame.

EasyFit V-Tec sleeping roof front high

Standing height 175 / 227 cm

Belt fastener	2806015	5499,-
Safety lock	2806016	5799,-

LUXURY sleeping roof bed, including disc spring system

Plate spring system for increased sleeping comfort, ventilated from below. Sleeping surface approx. 190 x 140 cm, upholstery dimensions approx. 186 x 130 x 4 cm. With cover for entrance opening.

280720	749,-
--------	-------

Freight flat rate for sleeping roof: For delivery within Germany

or collection from specialist dealer	225	103,99
--------------------------------------	-----	--------

RENAULT TRAFIC - SLEEPING ROOF EASYFIT

For Opel Vivaro B (until 3/2019)/Trafic, Nissan NV300, Fiat Talento (from 8/2014) short or long wheelbase



EasyFit sleeping roof for short wheelbase, front high

Gas-spring supported, roof positioned high at the front. With front and 2 side windows. The front can be opened with a zip. Side windows with mosquito nets. Canopy (100% polyester), grey tent bellows (100% cotton), incl. installation frame. Roof shell colour white.

With parts certificate*.

EasyFit sleeping roof, front high

Belt fastener	2806011	5299,-
Safety lock	2806012	5599,-

LUXURY sleeping roof bed, including disc spring system (available from 04/2021)

Plate spring system for increased sleeping comfort, ventilated from below. Sleeping surface approx. 190 x 140 cm, upholstery dimensions approx. 186 x 130 x 4 cm. With cover for entrance opening.

280720	749,-
--------	-------

Freight flat rate for sleeping roof: For delivery within Germany

or collection from specialist dealer	225	103,99
--------------------------------------	-----	--------

EasyFit sleeping roof for long wheelbase, front high

Gas-spring supported, roof position front high or rear high. With front and 2 side windows. The front can be opened with a zip. Side windows with mosquito nets. Canopy (100% polyester), grey tent bellows (100% cotton), incl. mounting frame. Roof shell colour white. With parts certificate*.

EasyFit sleeping roof, long wheelbase front high safety lock

2806111	6099,-
---------	--------

LUXURY sleeping roof bed, including disc spring system

Discspring system for increased sleeping comfort, ventilated from below. Sleeping surface approx. 190 x 140 cm, cushion dimensions approx. 186 x 130 x 4 cm. Cover for entrance opening not suitable for LR

280720	749,-
--------	-------



Sleeping roof EasyFit for long wheelbase rear high

Belt buckle	2806113	6299,-
--------------------	---------	--------

Sleepingroof bed

Sleeping area 215 x 130 cm including cushion

28069	715,83
-------	--------

Freight flat rate for sleeping roof: For delivery within Germany

or collection from specialist dealer	225	104,-
--------------------------------------	-----	-------

*only valid with our offered installation frames. Standard colour of the roofs white, illustrations partly show additional equipment. For an additional charge, we will also be happy to paint your vehicle roof in the colour of your choice. Wires and roof hoods installed in the roofs and shown are not included in the scope of delivery.



RENAULT TRAFIC KR - SUPER FLAT SLEEPING ROOF

For Opel Vivaro, Renault Trafic, Nissan Primastar, short wheelbase, up to year of manufacture 6/2014

Gas spring supported, roof installation front high. 2-piece with front window, active rail can be fitted, without additional vehicle elevation. Mosquito net with zipper. Front can be opened with zipper. Vehicle height with roof approx. 200 cm. Sky (100% polyester), tent bellows grey (100% cotton). With parts certificate*.

Roof shell colour white	280502	3499,-
2-section bed, 15 mm wooden top (high freedom of movement in living position). Sleeping surface approx. 188 x 132 cm		
With 4 cm thick foam and grey cover (100% polyester)		
Incl. bed pads	28054	694,43

Installation frame

with cab cut-out. TÜV approval. Bed support integrated. Headroom in the driver's cab, easy "walk behind". Roof cut-out approx. 240 x 108 cm. Not with Sunroof in the driver's cab

	280482	789,-
--	---------------	--------------

Freight flat rate for sleeping roof: For delivery within Germany or collection from specialist dealer

	225	104,-
--	------------	--------------



RENAULT TRAFIC - HUBDACH EASYFIT ULTRAFLAT

Also for Opel Vivaro B (until 3/2019), Nissan NV300, Fiat Talento (from 2014)



New lifting roof with EasyFit subframe and integrated front spoiler. The EasyFit sub-frame allows perfect adaptation to the roof structure of the vehicle. The roof offers standing height in an area of 98x92 cm. Between B- and C-pillar 50 cm more height with open roof, 5 cm with closed roof. Vehicle height with closed roof approx. 203 cm.

HD ultra flat for Renault Trafic	2022111	2699,-
---	----------------	---------------

Flat-rate freight charge for lifting roof: For delivery within Germany or collection from specialist dealer

	227	53,40
--	------------	--------------



*only valid with our offered installation frames. Standard colour of the roofs white, illustrations partly show additional equipment. For an additional charge we can also paint Your vehicle roof in the colour of your choice. Windows and roof hoods installed in the high roofs and shown in the illustrations are not included in the scope of delivery. More work required for vehicles with air-conditioned roof (from 2014).

SLEEPING ROOF FOR MAXI VANS

For 2 more sleeping places in your camper



- The sleeping roof offers 2 additional sleeping places
- Easy, manual erection thanks to gas spring
- High comfort scissors with approx. 45 cm legroom
- Roof bed sleeping area up to 200 x 120 cm
- Equipped with 3 windows as standard, 2 of which incl. mosquito nets
- Mounting of an awning possible

The sleeping roof for the Maxivan offers 2 additional comfortable sleeping places in your van. It is always delivered in 3 parts to make the assembly as easy as possible: Roof shell including pre-assembled mechanics and tent bellows, the GRP sub-frame as well as the front spoiler.

The GRP subframe is glued to the body, the roof shell is mounted on it and the tent bellows is attached in the classic way with tent bellows strips.

The GRP frame requires a mounting surface of 275 x 145 cm. The front spoiler requires a mounting length of approx. 45 cm, but can also be mounted in the area of the front roof slope or omitted, as long as it is ensured that the airstream is directed over the roof.

The entire assembly takes place above the roof sheet, as roof cutout e.g. the hatch opening of a Hekis is sufficient. Roof locking with straps. The bed cushion is directly ventilated on the roof plate.



Access hatch with access ladder



45 cm legroom in the roof bed for high sleeping comfort

Sleeping roof Fiat Ducato from length L2, height H2

The positioning of the roof is intended in such a way that an existing cutout of a Heki directly behind the driver's cab can be used as a passage.

The GRP frame then ends exactly in the area of the transverse bead of the roof sheet. Roof hatches which lie behind the transverse corrugation can be retained. The positioning results in a roof bed length from the cut-out of 180 cm, which can be extended to 2 m with an additional part if required (optional). Installation height approx. 18 cm.

The simultaneous installation of an awning is possible thanks to awning adapter cut-outs on the sleeping roof. If no awning is fitted, an optionally available cover set can be inserted into the recesses.

Sleeping roof for Fiat Ducato L2 H2	28066906	4499,-
Sleeping roof for Fiat Ducato L4 H2	28066902	4399,-
Roof bed Maxivan Ducato		
Bed cushion 120 x 180 cm	280670	438,70
Bed extension Maxivan Ducato sliding board with bed cushion 120 x 200 cm, for extending the roof bed to 2 m sleeping length	280672	144,45
Access ladder for easy access to the roof bed	42122	133,23
Cover set for awning adapter recesses	280662	Price on request

More maxi van sleeping roofs:

Sleeping roof VW Crafter from year of construction 2017, H3 vehicle height 262 cm, with 6 m vehicle length

The roof is positioned in such a way that the access can be made in the roof hatch area behind the bar in the sliding door area. Body height approx. 24 cm.

28066541 4999,-

Sleeping roof Mercedes Sprinter from 2006, with 6 m vehicle length Body height approx. 22 cm .

28066361 4999,-

Universal sleeping roof for large vans e.g. Renault Master, Ford Transit or Hyundai H 350.

Note: Subframe, spoiler and possibly roof shell must be adapted

28066001 4999,-

Roof bed VW Crafter, Mercedes Sprinter and Universal suitable for above mentioned roofs Bed cushion 120 x 200 cm, ventilated

28067 438,70

REIMO ROOF VARIANTS

which Reimo roof fits your vehicle



Sleeping roof (SD)

- Suitable for underground car park (height depends on model)
- Additional sleeping berths possible
- Inclined arrangement
- Standing height in the living area
- 2 large lockable mosquito net windows
- Roof rack possible (30kg)
- Large foil windows
- Solar cell possible
- Vehicle elevation approx. 7-15 cm

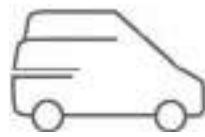

High roof(HOD)

- All-weather
- Standing height in the living area
- Additional storage space possible
- Additional sleeping berths possible
- Aerodynamic shape
- Ventilation through skylight possible
- Roof rack possible
- Sunroof / hood possible
- Vehicle elevation approx. 45-75 cm

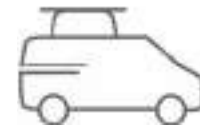

Lifting roof(HD)

- Inexpensive
- Headroom in the living area -
- 45 cm extra on approx. 1m length
- Good ventilation (3 closable mosquito net windows)
- Can be set up parallel
- Universal for many vehicles possible
- Vehicle elevation approx. 6-12 cm

Welches Reimo Dach passt auf Ihr Fahrzeug (Die Ziffer im Kreis steht für die Fahrzeuglänge)

Hersteller	Typ	Baujahr	Baugleich	SD Easyfit hinten hoch	SD Easyfit vorne hoch	SD superflach vorne hoch	SD superflach hinten hoch	SD Maxivan*	HOD Aeroline	HOD Sportline	HOD Ergoline	Hubdach	Fahrzeuginnenlänge (Radstand) in mm					
													Höhe ohne Dach ca. m	①=L1	②=L2	③=L3	④=L4	
Citroen	Berlingo	2018-	14	②									1,9	4403(R2785)	4753(R2797)	-	-	
	Spacetourer	2016-	12		②							Uni*	1,9	4606(R2925)	4956(R3275)	5308(R3275)	-	
	Jumpy	2016-	12		②							Uni*	1,9	4606(R2925)	4956(R3275)	5308(R3275)	-	
	Jumper	1994-2006	1									Uni*	2,1	4749(R2850)	5099(R3200)	5599(R3700)	-	
Fiat	Jumper	2006-	13					②③④					2,5	4963(R3000)	5413(R3450)	5998(R4035)	6363(R4035)	
	Ducato	1994-2006	1								①②	Uni*	2,1	4749(R2850)	5099(R3200)	5599(R3700)	-	
	Ducato III	2006-	13					②③④				Uni*	2,5	4963(R3000)	5413(R3450)	5998(R4035)	6363(R4035)	
	Talento	2016-	8	①	①	①②	②					Uni*	2	4999(R3098)	5399(R3498)	-	-	
Ford	Transit Custom	2013-				①	①					Uni*	2	4972(R2993)	5339(R3300)	-	-	
Hyundai	H1	2008-				①*						Uni*	1,9	4685(R2800)	-	-	-	
Mercedes	Vito W447	2014-	11		②	①②③					②	Uni*	1,9	4748(R3200)	5140(R3200)	5370(R3430)	-	
	Viano W447	2014-	11		②	①②③					②	Uni*	1,9	4748(R3200)	5140(R3200)	5370(R3430)	-	
	Vito (W/V639)	2003-2013	6			①②③					②	Uni*	1,9	4895(R3200)	4993(R3200)	5223(R3430)	-	
	Viano	2003-2013	6			①②③					②	Uni*	1,9	4748(R3200)	4993(R3200)	5223(R3430)	-	
	Vito (W638)	1996-2003	5			①					①	Uni*	1,9	4660(R3000)	-	-	-	
	V-Klasse	1996-2003	5			①					①	Uni*	1,9	4660(R3000)	-	-	-	
	Sprinter (VS30)	2018-						②③④					2,6	5267(R3259)	5932(R3924)	6967(R4325)	7367(R4325)	
	Sprinter (NCV3)	2006-2018	4					②③④				Uni*	2,6	5245(R3250)	5910(R3665)	6945(R4325)	-	
Sprinter (T1N)	1996-2006	3								①②	Uni*	2,4	4889(R3000)	5639(R3550)	6589(R4025)	-		
Nissan	NV300	2014-	8	①	①②		②					Uni*	2	4999(R3098)	5399(R3498)	-	-	
Opel	Combo	2018	14	②									1,9	4403(R2785)	4753(R2797)	-	-	
	Primostar	2001-2013	7			①					①	Uni*	2	4782(R3098)	5182(R3498)	-	-	
	Vivaro X82	2014-	8	①	①②		②					Uni*	2	4999(R3098)	5399(R3498)	-	-	
	Vivaro	2001-2013	7			①					①	Uni*	2	4782(R3098)	5182(R3498)	-	-	
Peugot	Rifter	2018-	14	②									1,9	4403(R2785)	4753(R2797)	-	-	
	Traveller	2016-	12		②	②						Uni*	2	4606(R2925)	4956(R3275)	5308(R3275)	-	
	Expert	2016-	12		②	②						Uni*	2	4606(R2925)	4956(R3275)	5308(R3275)	-	
	Boxer	1994-2006	1								①②	Uni*	2,5	4749(R2850)	5099(R3200)	5599(R3700)	-	
RAM	Boxer II	2006-	13					②③④					2,5	4963(R3000)	5413(R3450)	5998(R4035)	6363(R4035)	
	Promaster	2009-	13					②③④					2,5	4963(R3000)	5413(R3450)	5998(R4035)	6363(R4035)	
Renault	Trafic X82	2014-	8	①	①②		②					Uni*	2	4999(R3098)	5399(R3498)	-	-	
	Trafic	2001-2013	7			①					①	Uni*	2	4782(R3098)	5182(R3498)	-	-	
Toyota	ProAce	2016-	12		②							Uni*	1,9	4606(R2925)	4956(R3275)	5308(R3275)	-	
	ProAce City	2018-	14									Uni*	1,9	4403(R2785)	4753(R2797)	-	-	
	Hiace H200**	2004-			①*							Uni*	1,9	-	4695(R2570)	-	-	
	Hiace / Granvia	1995-2002										Uni*	1,9	4750(R2985)	-	-	-	
VW	Regius	1997-2002					①*					Uni*	1,9	4750(R2985)	-	-	-	
	Caddy (Maxi)	2015-2020	11				②					Uni*	1,9	4408(R2682)	4878(R3006)	-	-	
	Caddy (Maxi)	2003-2014	11				②					Uni*	1,9	4406(R2681)	4876(R3006)	-	-	
	Caddy (Maxi)	2021-					②					Uni*	1,9	-	4878(R3006)	-	-	
	T6, T6.1	2015-	9	①②	①②	①②	①②				①	①②	①②	2	4892(R3000)	5292(R3400)	-	-
	T5	2003-2014	9	①②	①②	①②	①②				①	①②	①②	2	4892(R3000)	5292(R3400)	-	-
	T4	1990-2003			①②	①②					①②	①②	①②	2	4707(R2920)	5107(R3320)	-	-
	T3	1979-1990/92									①	①	①	1,9	4600(R2460)	-	-	-
Crafter	Crafter	2006-2016	4					②③④				Uni*	2,6	5245(R3250)	5910(R3665)	6945(R4325)	7340(R4325)	
	Crafter	2017-						②③④				Uni*	2,6	-	5986(R3640)	6836(R4490)	7391(R4490)	
	LT2	1996-2006	3							①②	①②③	Uni*	2,4	4889(R3000)	5639(R3550)	6589(R4025)	-	

*=Einzelabnahme erforderlich, derzeit kein Teilergutachten/Herstellerfreigabe vorhanden. **=kein deutsches Modell

†= Teilergutachten in Arbeit

Baugleich heißt: gleiches Dach passt // Achtung, bei Kopfairbags in der Regel kein Dacheinbau möglich

Alle Angaben ohne Gewähr, Längenbezeichnungen L1-L4 können typspezifisch von Herstellerbezeichnungen abweichen

ACCESSORIES FOR SLEEPING ROOFS

Long and short wheelbase



Climacover weather protection cover

Ideal protection against rain, snow, ice and dirt. With windows and ventilation openings. Fits over the complete roof.

Climacover for VW T6/T5 from 2003 onwards

For KR, Easy Fit roof and California, front high	37391	456,90
For LR, Easy Fit roof, front high	37394	499,-
For KR, super flat sleeping roof, front high	37393	445,90
For KR, sleeping roof SCA 194, front high	37360	445,90

NEW:

Climacover for EasyFit-roof front high with high scissors from 2021

For VW T5/T6 KR/California/California Beach as of 2003

	373941	449,-
For VW T5/T6 LR	373940	439,-
For MB Vito long	373942	439,-



Sleeping roof tent bellows insulation inside

Protection from intense heat or cold. Can be opened by means of a zipper on the windows. Additional ventilation opening with zip. Mounting: by means of Velcro straps and Velcro discs (enclosed).

Interior insulation for VW T6/T5

For KR, super flat roof, front opening	37396	399,-
For KR, super flat roof, rear opening	37385	388,90
For KR, EasyFit SD, front opening	37398	399,-
For LR, super flat roof, rear and front opening	37397	399,-
For LR, EasyFit SD, front opening	37388	399,-
For California from 2003, California Beach 06/2010	37389	399,-

NEW: Insulation for EasyFit roof front high with high scissors from 2021 onwards

For VW T5/T6 KR	373981	419,-
For VW T5/T6 LR	373881	409,-
For MB Vito long	373882	399,-



Tent bellows tensioning rubber with quick release

Thanks to this practical elastic band, your sleeping roof tent bellows folds up perfectly.

It is simply placed around the tent bellows and fixed with the quick release. Can be shortened individually

442201 7,-



ACCESSORIES FOR SLEEPING ROOFS

① Active carrier rail set installed on the sleeping roof

(please order also, can be mounted afterwards badly) Ideal for the concealed fastening of a roof rack. 4 pieces á approx. 40 cm (mounted)

41320 369,-

② Active carrier profile 40 cm for retrofitting

Counter plate visible from inside can be covered with Isovelour (51015). 4 pcs. with counter plate, seal and screws

41303 199,-

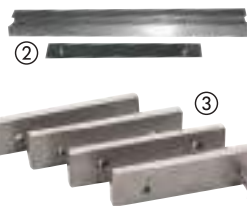
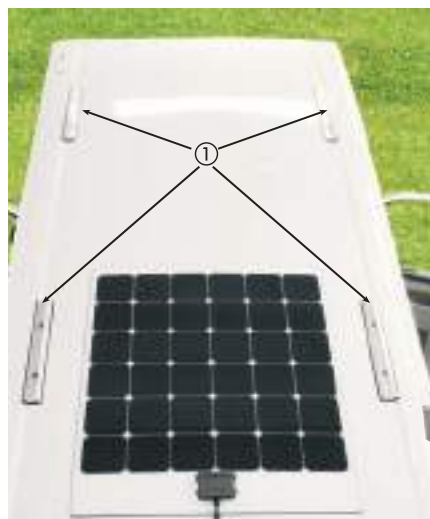

Thule roof rack system for pop-up roofs

Basic equipment for all vehicle types with Reimo active carrier profile

③ **Adapter plates** enable the attachment of the Thule fixed points 543 in the Reimo active rails **Scope of delivery:** 4 adapter plates, adapter plate Thule roof rack 64mm

41304 51,90

④ **Thule fixed point 543** The artificial fixed points replace the mounting points on car roofs. Set with 4 pieces incl. mounting material

41082 83,70

⑤ **Thule Support Foot Rapid 753** Set of 2

41093 72,80

Thule Support Foot Rapid 751 Set of 2

41092 70,81

⑥ **Thule Wingbar 135 cm**, 1 piece

410969 131,80

Thule Wingbar 150 cm, 1 piece (not shown)

410967 134,80

⑦ **Thule Slidebar 127 cm**, 1 piece

410964 274,90

Thule Slidebar 144 cm, 1 piece

410963 334,79



Mounting Vehicle specific	Material required	⑤ Thule Support Foot Rapid 753, Set of 2 Item no. 41093	⑥ Thule support foot Rapid 751, set of 2 Item no. 41092	Suitable mounting kit	Mountable carrier (required quantity 2 pieces)
VW Caddy		2x		41091	Slidebars 127 cm, 1 piece, item no. 10964
VW T5/T6 without superstructure or flat solar panel		2x		41090	Wingbars 135 cm, 1 piece, item no. 410969 or lidebars 144 cm, 1 piece, Art.No. 410963
VW T5/T6 with higher installations on roof			2x		Wingbars 150 cm, 1 piece, item no. 410967 or Slidebars 144 cm, 1 piece, Art.No. 410963
Renault Trafic without higher roof structures		2x		410901	Wingbars 150 cm, 1 piece, item no. 410967 or Slidebars 144 cm, 1 piece, Art.No. 410963
Renault Trafic with higher roof structures			2x		



Roof rack for Reimo Multirail

Support feet (2 pieces) especially suitable for Reimo Multirail rail, Reimo Active rail and for rain gutter mounting. Max. load 100 kg pair of support feet: Height 20 cm

41180 89,95

Support tube: length 165 cm for above-mentioned support foot. Square tube 32 x 22 mm, black plastic coating. TÜV-approved. The roof support must be removed before opening the sleeping roof. Per piece

41125 41,90



NOTE: Order accessories when ordering the sleeping roof. Subsequent installation is possible, but usually involves significantly higher costs and technical compromises. Standard colour of the roofs white, illustrations partly show additional equipment. Subject to technical changes and printing errors.

SOLAR TECHNOLOGY FOR HIGH AND LOW ROOFS

Ultra-flexible high-performance solar modules, factory mounted on sleeping roofs

Ideal for sleeping roofs. The modules are only 3 mm thick and therefore do not affect the vehicle height. The honeycomb structure reduces heating by the sun. Sunpower cells provide a significant increase in power output even when the angle to the sun is not optimal.

Solar panel Ultra 130W white flexible version incl. charge controller PRS 300. Dimensions: 920 x 800 x 3 mm, glued onto the sleeping roof. For all Reimo sleeping roofs except Caddy **1SW21 999,-**

Solar system for Caddy Maxi 110W white flexible version incl. charge controller PRS 300, dimensions: 1125 x 540 x 3 mm, glued onto the sleeping roof. **1SW22 1099,-**



Panels on sleeping roof VW T5/T6 KR

Panels on Caddy Maxi



Solar module sets for retrofitting for roofs with 100-150 Watt module output

- MPP charge controller "NDS SC300M" included
- Including roof feed-through

Profiflex-110 Set White or Black: Price-buster set with the Carbest 110 W solar module. For example for light, water pump, occasional heating

Profiflex-150 Set Black: Set with the Carbest 150 W solar module. e.g. for light, pump, TV/Sat, heating and possibly compressor fridge

Material carrier plate: Black modules made of stable fiberglass, White modules made of more flexible highly bendable TPT.

All sets with **MPPT charge controller** 12 V/150 W (12.5 A) for gel, AGM, acid or LiFePO4 batteries. 2 separate battery circuits. 2 panels can be connected, standby consumption: 5 mA, **TIP:** For bonding the modules to the vehicle roof, we recommend cleaner 29415, primer 294470 and adhesive 294112

Solar complete set	PF-110 White	PF-110 Black	Square-130 White	PF-150 Black
Module power WP	110 W	110 W	130 W	150 W
Power Wh/day	400	400	400	540
Solar module	1 x 853170	1 x 853172	1x 851563	1 x 85329
Position controller	851005	851005	851005	851005
Controller power	165 W	165 W	165 W	165 W
Cable gland	85201	85201	85201	85201
Dimensions in mm	1125 x 540 x 3	1100 x 540 x 2.5	860 x 800 x 3	1470x540x3
Suitable for	Caddy sleeping roof, high roof	Caddy sleeping roof, high roof	Reimo sleeping roofs	Reimo High roof
Art. No.	85272	85271	85274	85275
Price	369,-	379,-	419,-	548,99



MPP controllers have delivered up to 25% more current than conventional charge controllers in our tests.

ACCESSORIES FOR HIGHROOFS

- ① Aluminium high roof pop-up window Ideal window for Reimo high roofs or alcoves. Very good ventilation in the roof. Mounting on the side with stable outer frame in silver with a wall thickness of 30-35 mm. Cut-out size 460 x 160 mm. A wooden subframe (not included) must be fitted during installation. Depending on the installation situation, this must be manufactured by the customer.

34432 249,-

Replacement sash for window **34432:**

34433 189,-

- ② S-4 pop-up window including inner frame, insect screen and blackout roller blind **31201 460,99**

Window cover profiles

Perfect transition to the interior cladding. The profile is cut to the depth of the respective wall thickness, glued or fastened with cap screws (not included)

- ③ Interior profile rod 2 m Light grey **38000 9,95**

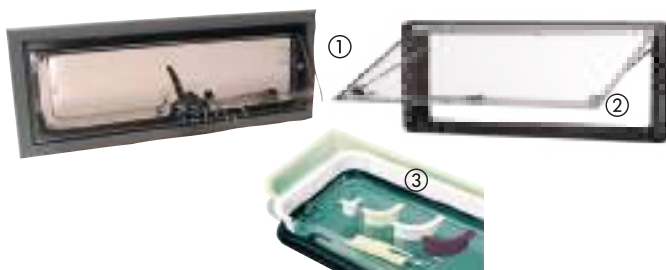

Sealing compound

For the installation of windows, roof bonnets, boot flaps and other elements with frames. On the exterior surfaces of motorhomes, vans and caravans.

DEKASEAL 8936 dab-on sealant

Colour: anthracite 310 ml **50030 13,44**

GP 37,90/1litre

Colour: light grey 310 ml **500306 14,95**

GP 37,90/1litre

Sika Lastomer 710 permanently elastic sealant

Does not harden excessively under UV radiation

Colour: White 310 ml **38062 13,44**

GP 35,45/1litre

Colour: Black 310 ml **38060 13,23**

GP 35,45/1litre



Installation tip for windows

Insert the window from the outside into the cut-out (approx. 1 mm larger than the frame dimension) and screw it with clamps and screws against the necessary wooden frame. Use the above sealant for sealing. Finish on the inside with interior window cladding

UNIVERSAL POP UP ROOFS

For vehicles for which Reimo does not offer special roofs



More
Quality of life
through a
Pop Up Roof

Pop Up Roof ultra-flat EasyFit for Renault Trafic, Opel Vivaro, Nissan NV300, Fiat Talento long wheelbase from model year 2014 on page 135



Notes for the self-builder: TÜV individual acceptance required

Provided that no bows have to be cut or moved in the cut-out area, there are usually no additional requirements for the conversion. However, it should be checked in the road test whether a wind deflector/ spoiler profile is necessary. This is usually advisable for vehicles that reach over 140 km/h or where the roof shape or bodywork dictates inadequate aerodynamics. If bows are removed or relocated, the vehicle manufacturer's installation guidelines must always be observed. This intervention should be discussed in advance with the TÜV expert who will also inspect the vehicle later. It is also important to note where the necessary seat belt points are. In the case of cut-outs that also go through the area of a bow, a frame profile is usually recommended that transfers the weakening through the cut-out area to other bows in a force-fit manner

Example: Square tube 40 x 20 x 1.5 mm with lugs to the bows, or correspondingly bent sheet metal profile, which absorbs the weakening of the bodywork through the cut-out.

Particular attention must be paid to the frictional connection to the adjoining bows. For this purpose, we recommend solutions such as those used for the Volkswagen Transporter. The supplied wooden installation frame is usually only to be seen as a support frame to which the tent bellows can be stapled. Although a static property is given, it does not have to be accepted or recognized as sufficient within the scope of the test according to §19/2 StVZO. The operating permit of the vehicle expires as a result of the modification made. After the modification, the vehicle must be presented to an officially recognised expert for inspection in accordance with §19/2 StVZO (changes to the vehicle documents)



Pop Up Roof T6/T5 on page 125



Pop Up Roof T4 on page 126



Pop Up Roof T3 on page 128

Universally applicable, gas spring supported. To be set up in parallel. Mechanics for vehicles with very low or higher roof curvature. Surface dyed white, paintable. Raising of the interior by approx. 45 cm. Ventilation: 3 closable tent fabric windows with mosquito nets. Tent bellows grey, 100% cotton. Incl. wooden mounting frame.

Pop Up Roof for panel vans/vans

(e.g. Ford Transit Custom, Renault Trafic, Opel Vivaro)

Pop Up Roof EasyFit Universal with integrated spoiler

Height of Pop Up Roof closed: 50-150 mm, height open: 445 mm. Pop Up Roof Easy-Fit lower frame is not adapted to the body. Roof shell size: W 1300 x L 1700 mm Roof cut-out size: W 1040 x L 970 mm

2022101 2719,-



Item no. 2022101

Pop Up Roof for Minicamper

(Kangoo, Berlingo etc.)

Pop Up Roof Universal Standard

For vehicles with a small roof area. Roof dimensions approx. L145 x W108 x H17 cm, roof cut-out approx. L107.5 x W88.5 cm or smaller. Distance of the mechanics approx. 92 cm

Roof support angle 90°

20212 1499,-

Roof support angle 105°

20213 1499,-



Item no. 20212

Pop Up Roof with normal shell for roofs with normal width

Pop Up Roof Universal Ultraflat I, roof support angle 90°

For vehicles with no or only very slight roof curvature. Dimensions approx. L162 x W128.5 x H14 cm, roof cut-out approx. L110 x W94 cm or smaller. Distance of the mechanics approx. 98 cm

20216 1599,-

Pop Up Roof Universal Ultraflat I, roof support angle 105°

Roof dimensions approx. L162 x W128.5 x H14 cm, roof cut-out approx. L110 x W104 cm or smaller. Distance of the mechanism approx. 108 cm

20215 1599,-

Pop Up Roof universal superflat, roof support angle 90°

Mechanism for vehicles with slight roof curvature. Roof dimensions approx. L175 x B132 x H14 cm.

Distance of the mechanics approx 107 cm.

Roof cutout approx. L107,5 x W101 cm or smaller

20210 1599,-

Roof cutout approx. L130 x W104 cm or smaller

202100 1599,-

Pop Up Roof Universal Superflat, roof support angle 105°

Roof dimensions approx. L175 x W128.5 x H14 cm, roof cut-out approx. L110 x W104 cm or smaller. Distance of the mechanism approx. 108 cm

20211 1499,-



Item no. 202100

Pop Up Roof with narrow shell for narrow roofs

Pop Up Roof Universal Ultraflat II, roof support angle 90°

For narrower vehicles (shell width approx. 118 cm). Standing height (approx. +45 cm) with little effort. Vehicle elevation approx. 5 -12 cm. Roof dimension approx L162 x W118,5 x H14 cm, roof cutout approx.

L110 x W94 cm or smaller. Distance of the mechanics approx. 98 cm

20214 1599,-

Pop Up Roof Universal Ultraflat II, roof support angle 105°

Roof dimensions approx. L162 x W118.5 x H14 cm, roof cut-out approx. L110 x W94 cm or smaller. Distance of the mechanism approx. 98 cm

20220 1530,10



Item no. 20211

Flat-rate freight charge for Pop Up Roof: For delivery within Germany or collection from dealer

227 53,40

As **wind deflector** we recommend the installation of the spoiler profile: **29365** (1.6 m bar) in front of super flat lift roofs

Subject to technical changes.

SPARE PARTS FOR SLEEPING ROOFS

Example: Sleeping roof (SD) Universal



① Sealing profile, ② shears, ③ gas springs		
④ Rubber seal for SD-shears	29307	7,79
⑤ Counter plate for SD-scissors, 325 mm	29345	14,90
⑥ Counter plate 100 mm. For gas spring holder	29346	12,99
⑦ Top gas spring bracket. Mounting gas spring on SD shell		
⑧ Gas spring bracket bottom. Fastening gas spring to body		
⑨ Seal for gas spring bracket approx. 100 cm	29308	4,66
⑩ Plastic handle, spare part hole distance 150mm, grey	293204	2,95
⑪ Locking bracket (door retaining cramp) metal, black	29471L	3,99
ditto, plastic brown 40 mm	29425	1,65
⑫ Reimo special belt approx. 60 cm long with very robust buckle . Closing strap for our sleeping roofs	44208	4,61

The spare parts for Reimo sleeping roofs can be found on the Reimo website in the spare parts shop under Reimo/Sleeping roof spare parts.

Spare parts for sleeping roofs

Roof part no.	Designation	① Seal profile	Price per meter	Tent bellows	Price/piece	② Pair of scissors	Price per pair	③ Gas spring	Price per piece	⑦ Gas spring holder top	Price per piece	⑧ Lower gas spring retainer	Price per piece
210960	VW T5 super flat KR front high	294511	10,59	292960	491,13	29610	248,-	293120	71,-	293900	23,63	293900	23,63
2115003	VW T5 KR rear high / Easy Fit	294511	10,59	2929610	449,-	29610	248,-	293120	71,-	293900	23,63	293900	23,63
21075	VW T5 super flat LR rear high	294511	10,59	292891	512,53	29610	248,-	293120	71,-	293900	23,63	293900	23,63
21085	VW T5 superfl. LR front high, 2-pcs.	294511	10,59	292981	502,90	29610	248,-	293120	71,-	293900	23,63	293900	23,63
2115001	VW T5 Easy Fit KR front high	294511	10,59	2929610	480,43	29610	248,-	293120	71,-	293900	23,63	293900	23,63
2116201	VW T5 Easy Fit LR front high	294511	10,59	2929650	501,83	29610	248,-	293120	71,-	293900	23,63	293900	23,63
21115	VW T4 KR super flat 2 front high	29451	10,25	29211	544,63	29325	290,-	293120	71,-	29352A	20,-	29354	30,-
21121	VW T4 LR super flat 2 front high	29451	10,25	29213	523,23	29325	290,-	293120	71,-	293900	23,63	29364	19,-
21130	VW T4 KR super flat rear high	29450	11,94	29131	656,98	29300	280,-	293120	71,-	293900	23,63	29364	19,-
21140S	VW T4 KR Easy Fit	29451*	10,25	29211	544,63	29325	290,-	293120	71,-	293900	23,63	29354	30,-
21160	VW T4 KR Elegance	29453	19,90	29160	416,23	29300	280,-	293120	71,-	293900	23,63	29354	30,-
20136	VW T3 super flat	29450	11,94	29210	469,73	29301	450,-	293120	71,-	293900	23,63	29375=li 29376=re	23,-
2211801	VW Caddy Maxi LR rear high	29450	11,94	29294	448,33	29610	248,-	29385	75,-	293900	23,63	293900	23,63
23130	Merc. Vito superfl. vo. ho. LR from 04	29450*	11,94	29235	491,13	29300	280,-	293120	71,-	293900	23,63	293900	23,63
23115	Merc. Vito superfl. vo. ho. LR until 03	29451*	10,25	292311	501,83	29325	290,-	293120	71,-	29352A	20,-	29367	62,-
23140	Merc. Vito KR 2004-2013	29451*	10,25	29245	480,43	29300	280,-	29385	75,-	293900	23,63	29346	12,99
2316001	Merc. Vito long from 2014	294511	10,59	29164	480,43	29610	248,-	293120	71,-	293900	23,63	293900	23,63
23150	Merc. Vito extra long 2004-2013	29451	10,25	29240	491,13	29300	280,-	293120	71,-	293900	23,63	29346	12,99
2806011	Ren. Trafic/Opel Vivaro KR as of 7/2014	294511	10,59	29223	480,43	29610	248,-	293120	71,-	293900	23,63	293900	23,63
2806111	Ren. Trafic/Opel Vivaro LR as of 7/2014	294511	10,59	29224	480,43	29610	248,-	293120	71,-	293900	23,63	293900	23,63
280502	Ren. Trafic/Opel Vivaro KR until 2014	29451	10,25	292504	469,73	293271	257,-	29385	75,-	29352A	20,-	29352A	20,-
22115	SD Ford from 7/2013	294511*	10,59	29222	491,13	29610	248,-	293120	71,-	293900	23,63	293900	23,63
Spoiler profile for sleeping roof 210960, 23130, 21115, 29365, 23140, 23115						29365	28,-						

You will need approx. 10 m of staple tape (15 x 1.4mm) for the tent bellows fastening: 294331 4.25/lfm.

* You need approx. 10 m sealing profile



The spare parts for Reimo pop-up roofs can be found on the Reimo website in the spare parts shop under Reimo/Prop-up roof spare parts.

Spare parts for Pop Up Roofs

Roof part no.	Designation	① Seal profile	Price per meter	Tent bellows	Price per piece	② Pair of scissors	Price per pair	③ Gas spring	Price per piece
20211	Universal super flat 1100 x 1040 / 105°	29451**	10,25	29201	319,93	29306 (105°)	299,-	29310	48,10
20210	Universal super flat 1100 x 1040 / 90°	29451**	10,25	29203	319,93	29303 (90°)	329,-	29310	48,10
20215	Universal ultraflat 1 / 105	29451**	10,25	29201	319,93	29306 (105°)	299,-	29310	48,10
20216	Universal ultraflat 1 / 90	29451**	10,25	29201	319,93	29303 (90°)	329,-	29310	48,10
202100	Universal ultra flat 1 / 1300 x 1040	29451**	10,25	29202	319,93	29303 (90°)	329,-	29310	48,10
20220	Universal ultraflat 2 / 105°	29451**	10,25	29190	319,93	29306 (105°)	299,-	29310	48,10
20214	Universal ultraflat 2 / 90	29451**	10,25	29190	319,93	29303 (90°)	329,-	29310	48,10
20213	Universal standard / 105	29451**	10,25	29205	319,93	29306 (105°)	299,-	29310	48,10
20212	Universal standard / 90°	29451**	10,25	29205	319,93	29303 (90°)	329,-	29310	48,10
20200	Volkswagen Transporter 3	29451**	10,25	29204	319,93	29306 (105°)	299,-	29310	48,10
21185	Volkswagen Transporter 5 super flat	29451**	10,25	29203	319,93	29303 (90°)	329,-	29310	48,10
21210	Volkswagen Transporter 4 super flat 2	29451**	10,25	29203	319,93	29303 (90°)	329,-	29310	48,10

Approx. 5m of staple tape (15 x 1.4mm) is required for the tent bellows fastening: 294331 2.50/lfm. ** You need approx. 7 m sealing profile

If you still have gas springs for screws, please order 2x screw ball head 29313 per gas spring

All listed gas springs are equipped with a ball head.

Gas springs should always be replaced in pairs, otherwise the pressure could be different and possibly too weak!



Sleeping roof fastening profile set

4 active beams approx. 40 cm, drilled,
incl. counter plate **41303 199,-**

Active rails universal

198 cm long, drilled four times.
Per piece **41332 219,-**

PLEASE NOTE!

The fastening straps for our lifting and sleeping roofs ⑫ Article 44208 must be checked for damage at regular intervals, at least before each major holiday, to check for damage! Straps where the seam tears, damaged or torn straps must be replaced immediately.

We recommend (for your own safety) to replace the straps every 5 - 6 years.



REIMO VAN-CONCEPT

ROCK AND ROLL BEDS

In addition to the proven Reimo rock and roll bedsystems, you will find other bench systems and individual seats from other suppliers in this section. The range is supplemented by belt supports, safety belts and a large selection of swivel consoles.



- CONTENTS -

ADVANTAGES OF THE REIMO ROCK AND ROLL BED.....	148-149
VARIOTECH® 1000 SINGLE SEATS	150
VARIOTECH® 3100 RIGID BENCH SEAT VW T6.1/T6/T5.....	151
VARIOTECH® 3000 FOR VW T6.1/T6/T5.....	152
VARIOTECH® 3000 FOR MERCEDES VITO	153
VARIOTECH® 3000 FOR RENAULT TRAFIC	154
VARIOTECH® 3000 FOR FORD TRANSIT	155
SAFETY BELTS	156
SEAT/SLEEPER BENCHES	157-159
SINGLE SEATS	160
HARNESSES	161-163
SWIVEL BRACKETS.....	164-167

THE REIMO SLEEPING AND BENCH SYSTEME

Many advantages for living and sleeping

For Volkswagen Transporter, Mercedes Benz Vito, Ford Transit, Renault Trafic, Opel Vivaro, Nissan NV300, Fiat Talento



Picture shows V3100

Reimo offers you sleeping/seating bench systems in four different widths from 1155 mm to 1380 mm.

The benches consist of 3 registered seats. The bed is formed with the bench and the integrierten rear cushion. The beds have a size depending on the bench or vehicle of approx. width 126 cm to 160 cm and a length of approx. 205 cm.

Furthermore, the benches must meet the stability requirements according to European regulations (ECE) in order to guarantee the safety of the seats while driving. Therefore, we have our benches extensively tested by the TÜV. TÜV-tested vehicle mountings are available for various vehicles

SEAT BENCHES FOR VW TRANSPORTER:

You want more variable driving positions for your seat bench?

By installing your bench seat at the Reimo factory, more seat positions are possible while driving. Your dealer can coordinate this service with us for you. The sale of bench seats can only be carried out by specialist dealers trained by Reimo.



Top sleeping comfort due to the completely flat sleeping surface. The beds have, depending on the bench or vehicle, a width of approx. 126 cm to 160 cm and a length of approx. 205 cm.



Two Isofix holders ensure secure attachment of two child seats. For use, only the zipper in the cushion must be opened.



A stowage compartment flap is integrated into the rear storage compartment.

When the bench seat is converted into a bed, it allows quick access from the vehicle interior to travel utensils and luggage in the luggage compartment. This means that it is not necessary to leave the vehicle to access the stowage space. Particularly practical in bad weather.



Under the rear cushion there is a storage height of 46 cm. There is plenty of room for tall crates of drinks. With the rear upholstery folded up, bulky items such as a washing machine or refrigerator can also be stowed. By moving the bench seat all the way forward behind the front seats, the storage space is increased accordingly.



Choice of optional bench trim for more load-through capability or optional bench drawer for more storage space

Reimo Variotech® V3000 - the movable and removable bench

- With variable living and luggage space size
- Several driving positions possible depending on vehicle and installation
- Safety belts integrated in the backrest
- Top sleeping comfort due to completely flat lying surface without disturbing belt buckles
- Quick bed assembly with just a few moves, without having to move the bench
- Good seating comfort on long journeys due to ergonomic upholstery of seat and backrest
- Rear cushion can be folded up to expand the boot loading volume
- Long items can be loaded through when the optional front panel or drawer is removed
- All seats are equipped with 3-point safety belts
- Isofix mounting for up to two child seats
- TÜV tested safety concepts according to ECE 14 & ECE 17
- TÜV tested for motorhome approval (N1) and passenger car (M1) depending on type
- Width of the bed (depending on bench or vehicle): 126 cm to 160 cm, length approx. 205 cm
- The retractable headrests do not have to be removed to build the bed



The Variotech® V3000 with optional drawer. This offers additional storage space for e.g. shoes, cables or on-board tools. The drawer can be removed for loading long parts. Dimensions depending on the width of the bench: H 17 cm, D 69.5 cm and W from 49.5 - 66.5 cm

Reimo Variotech® V3100 - the firmly bolted bench

The Variotech® V3100 bench offers the same advantages as the Variotech® 3000, apart from sliding. This rigid bench is firmly attached to the vehicle floor and is available for the VW T6/T5 with short as well as long wheel-base. Depending on the bench or vehicle, the beds have a width of approx. 126 to 160 cm and a length of approx. 190 cm.



Reimo Variotech® V1000 - the comfortable single seats

Comfortable single seats with plenty of legroom become comfort single beds. Dimensions: 1x 200x 65 and 1x 190x65 cm. The single beds provide free access to the rear. Storage space approx. 86 ltr .under each single seat.

From bench to bed in a few seconds using the V3000® as an example



1
Raised rear cushion with plenty of storage space in the rear



2
Fold-down rear cushion, storage space above and below it



3
Folded backrest and semi-tilted seat



4
Seat completely swivelled.



5
The head restraints remain installed and retract with



6
Finished flat sleeping position with comfort upholstery

See also our Youtube video on the Reimo Camping/Seating/Sleeping benches for camping buses channel

VARIOTECH® 1000

Sleeping / single seats

- **Comfortable single seats with plenty of legroom**
- **Comfortable single beds 1x 200x65 and 1x 190x65 cm**
- **Single beds provide free access to the rear**
- **Storage space under single seat approx. 86 ltr. per seat**

1 seat incl. safety belt which is fastened to the spar of the vehicle (see picture below). The seat is firmly bolted to the vehicle floor. Sitting on profiled seat and sleeping on the smooth back.

Total width:

driver's side left 660 mm

passenger's side right 680 mm, cushion width 600 mm for both seats

Sleepingsurface:

driver's side approx. 200 x 65 cm,

passenger side 190 x 65 cm,

Sleeping/single seat V1000for VW T5/T6

Scope of delivery:

Finished part, completely upholstered and pre-assembled with integrated, retractable headrest, safety belt, fastening material, safety belt. Additional upholstery is supplied

Note:

For the additional upholstery behind the seats you need a substructure (not included) which has to be manufactured by yourself depending on the vehicle. The front cushion rests on the turned cab seat. front panels can not be supplied by Reimo and must be manufactured yourself.

Single seat VW T5/T6 driving side:

Fabric Bricks (2-coloured, 100% polyester)	5835042	2279,-
Fabric Double Grid (2-coloured, 100% Polyester)	5835044	2279,-
Classic grey, 2-tone 100% polyester	5835000	2089,-
Tassamo T5, 2-coloured 100% polyester	5835008	2239,-
Austin T5, 2	5835024	2279,-
Austin T6, 2-coloured 100% polyester	5835022	2279,-
Simora T6, 2-coloured 100% Polyester	5835020	2279,-

Single seat VW T5/T6 passenger side:

Fabric Bricks (2-tone, 100% polyester)	5835052	2279,-
Fabric Double Grid (2-coloured, 100% Polyester)	5835054	2279,-
Classic grey, 2-tone 100% polyester	5835010	2089,-
Tassamo T5, 2-coloured 100% polyester	5835018	2279,-
Austin T5, 2-coloured 100% polyester	5835034	2279,-
Austin T6, 2-coloured 100% Polyester	5835032	2279,-
Simora T6, 2-coloured 100% Polyester	5835030	2279,-

Sleeping/single seat V1000 for Mercedes Vito, Renault Trafic, Opel Vivaro B, Fiat Talento

Scope of delivery :

Ready made, completely upholstered and pre-assembled with integrated retractable headrest, safety belt, fixing material, safety belt.

Note :

Additional upholstery for driver's seat and behind the backrest must be manufactured by the customer and cannot be supplied by Reimo. Front trims cannot be supplied by Reimo and must be manufactured by the customer.

Single seats Renault Trafic, Opel Vivaro, Fiat Talento

Fabric Luxe, 2-coloured 100% polyester left side	5837040	2279,-
Fabric Luxe, 2-coloured 100% Polyester right side	5837042	2279,-

Single seats Mercedes Vito

Fabric Tunja, 2-coloured 100% Polyester left side	5838050	2279,-
Fabric Tunja, 2-coloured 100% Polyester right side	5838052	2279,-



Fastening the belt to the vehicle spar



VARIOTECH® 3100

Rigid version - non-sliding

For Volkswagen Transporter T5/T6/T6.1

- For vehicles without side plastic trim
- 3 person sleeping/seating bench permanently installed
- Ready upholstered for 3 seats incl. rear upholstery
- 3 integrated, retractable headrests and 3 seat belts
- Isofix attachment points for a maximum of 2 child seats (middle seat cannot be used when using a child seat)
- Fold-up rear cushion, storage space height under rear cushion: 42 cm
- 1 integral foam side panel (size 17: 2 side panels)
- Delivery incl. support feet, please order fixing material separately

Size 8: Total width 1155 mm Upholstery width 1105 mm

Fabric Classic Grey (2-coloured, 100% polyester)	5040500	3869,-
Fabric Bricks T6.1 (2-coloured 100% Polyester)	5040542	4099,-
Fabric Double Grid T6.1 (2-coloured 100% Polyester)	5040544	4099,-
Leather (2-coloured)	5040506	5599,-
Front panel Basalt	5040580	179,-
Drawer Basalt	5040590	549,-

Size 10: Total width: 1205 mm - Upholstery width: 1155 mm -

Fabric Classic Grey (2-coloured, 100% polyester)	5040600	3869,-
Fabric Bricks T6.1 (2-coloured 100% polyester)	5040642	4099,-
Fabric Double Grid T6.1 (2-coloured 100% Polyester)	5040644	4099,-
Leather (2-coloured)	5040606	5649,-
Front panel Basalt	5040680	259,-
Drawer Basalt	5040690	549,-

Size 14: Total width 1305 mm - Upholstery width 1255 mm -

Fabric Classic Grey (2-coloured, 100% polyester)	5040700	3989,-
Fabric Bricks T6.1 (2-coloured 100% polyester)	5040742	4149,-
Fabric Double Grid T6.1 (2-coloured 100% Polyester)	5040744	4149,-
Leather (2-coloured)	5040706	5699,-
Front panel Basalt	5040780	239,-
Drawer Basalt	5040790	549,-

Size 17: Total width 1380 mm - Upholstery width 1330 mm -

Fabric Classic Grey (2-coloured, 100% polyester)	5040800	3919,-
Fabric Bricks T6.1 (2-coloured 100% polyester)	5040842	4199,-
Fabric Double Grid T6.1 (2-coloured 100% Polyester)	5040844	4199,-
Leather (2-coloured)	5040806	5829,-
Front panel Basalt	5040880	234,-
Drawer Basalt	5040890	499,-

Headrests with integral foam black series		
Surcharge for fabric upholstery	5070012B	136,40

Fixing material seat bench:

Order the required material for each type of bench	Carrier 1	Carrier 2	Carrier 3	Carrier 4
	582081	582082	582083	582084
	29,95	30,95	30,95	265,-
Mounting right (size 8-14)	1x	1x		1x
Mounting left (size 8-14)	1x		1x	1x
Center mounting (size 17)	2x	1x	1x	

In addition, 1 mounting kit 58208 89.90 is required in each case

Floor panel 1-piece for original VW sill trim decor ship's floor

KR: ca.. L 246 cm	105251	379,-	LR: ca.. L 286 cm	1053712	429,-
KR: ca.. L 246 cm	1053811	434,-	LR: ca.. L 286 cm	1053711	454,-

Décor Tessin

KR: ca.. L 246 cm	10538120	444,-	LR: ca.. L 286 cm	10537120	459,-
-------------------	----------	-------	-------------------	----------	-------

X-Trem insulator, 15 mm thick

Is needed as insulation under the base plate (2x for KR, 3x for LR).

Plate size 2 x 1 m	50016	19,99
--------------------	-------	-------



Illustration shows optional equipment



Seat with fabric cover Double Grid T6.1, and Isofix attachment point

You will find further bench seats for vehicles with side plastic panelling or for right-hand drive vehicles at www.reimo.com/Ausbaushop.

VARIOTECH®3000

Movable in Reimo Grizzly rails



Grizzly" slide rail set for Variotech® 3000

2 pieces, Grizzly rails, anodized aluminium

Short wheelbase Length 246 cm, 1 driving position	58200	426,59
Long wheelbase Length 286 cm, 2 driving positions*	58201	561,42

*3 driving positions with glued slide rails (by Reimo trained specialist companies)

Grizzly" fastening set for the slide rails

Adapter for screwing the Grizzly rails to the floor assembly

Rail spacing 997 mm, short wheelbase	58202	218,90
Rail spacing 826 mm, short wheelbase	58203	240,90
Rail spacing 651 mm, short wheelbase	58204	224,40

Supplementary set

For long wheelbase station wagon/van	58205	40,65
For panel van KR/LR	58206	42,85

Floor plates 3-parts, short wheelbase

	Décor ship's floor		Décor Quad		Décor Ticino	
Rail spacing	Item no	Price	Item no	Price	Item no	Price
① 651 mm	1053822	409,-	1053821	439,-	10538220	409,-
② 826 mm	1053832	409,-	1053831	439,-	10538320	409,-
③ 997 mm	1053842	409,-	1053841	439,-	10538420	409,-

Floor plates 3-piece, long wheelbase

	Décor ship's floor		Décor Quad		Décor Ticino	
Rail spacing	Item no	Price	Item no	Price	Item no	Price
① 651 mm	1053722	429,-	1053721	459,-	10537220	429,-
② 826 mm	1053732	429,-	1053731	459,-	10537320	429,-
③ 997 mm	1053742	409,-	1053741	459,-	10537420	429,-

X-Trem Insulator, 18 mm. Requires 2 plates for short wheelbase and 3 plates for long wheelbase. **50009 22,99**

Note: There are two options for mounting the seat rails: Rail bolting (1 seat position in the KR, 2 seat positions in the LR) or the special gluing procedure, which can only be carried out in companies equipped for this purpose. With this method, driving positions as well as additional single seats can be realized. A separate rail as well as other mounting material is required. There are 6 possible rail positions. The benches listed here are for mounting on the right (sizes 8, 10 & 14, or size 17 center) in the empty station wagon. If there is a heat exchanger in the rear, for positioning on the left in the vehicle and other upholstery combinations, a different article number is required in each case (specialist trade information folder)

Unupholstered bench seats can be supplied to specialist companies specially trained in upholstery.

For Volkswagen Transporter T5/T6/T6.1

For vehicles without side plastic trim

- 3 person sleeping/seating bench sliding and removable for empty left-hand drive vehicle without side panelling
- Ready upholstered for 3 seats
- 3 integrated, retractable head restraints and 3 seat belts
- Isofix attachment points for a maximum of 2 child seats (middle seat not usable when using a child seat)

① Size 8: Total width 1155 mm - Cushion width 1105 mm

Sleeping surface approx. 205x120 cm - Rail spacing 651 mm	Fabric	
Classic Grey (2-coloured, 100% polyester)	5040400	4339,-
Fabric Bricks T6.1 (2-coloured 100% Polyester)	5040442	4549,-
Fabric Double Grid T6.1 (2 coloured 100% Polyester)	5040444	4549,-
Leather 2-coloured	5040406	6269,-
Fabric Place T5 (2-coloured 100% polyester)	5040426	4599,-
Fabric Tasamo T5 (2-coloured 100% polyester)	5040408	4549,-
Fabric Austin T5 (2-coloured 100% polyester)	5040424	4549,-
Front panel mounted decor Basalt	5040480	249,-
Drawer mounted, decor bas	5040490	679,-

① Size 10: Total width 1205 mm - Cushion width 1155 mm - Sleeping surface approx. 205x126 cm - Rail spacing 651 mm

Fabric Classic Grey (2-coloured, 100% Polyester)	5040000	4249,-
Fabric Bricks T6.1 (2-coloured, 100% Polyester)	5040042	4549,-
Fabric Double Grid T6.1 (2-coloured, 100% Polyester)	5040044	4489,-
Leather 2-coloured	5040006	6269,-
Front panel mounted, decor basalt	5040080	249,-
Drawer mounted, decor bas	5040090	679,-

CityVan

② Size 14: Total width 1305 mm - Upholstery width 1255 mm - Sleeping area approx. 205x136 cm - Rail spacing 826 mm

Fabric Classic (2-coloured, 100% polyester)	5040100	4359,-
Fabric Bricks T6.1 (2-coloured, 100% Polyester)	5040142	4549,-
Fabric Double Grid T6.1 (2-coloured, 100% Polyester)	5040144	4549,-
Leather 2-coloured	5040106	6329,-
Front panel mounted, decor basalt	5040180	239,-
Drawer mounted, decor bas	5040190	679,-

Weekender Plus

② Size 14: Total width 1305 mm - Upholstery width 1255 mm - Sleeping surface approx. 205x136 cm - Rail spacing 826 mm

Fabric Classic (2-coloured, 100% polyester)	5040200	4365,90
Fabric Bricks T6.1 (2-coloured, 100% Polyester)	5040242	4549,-
Fabric Double Grid T6.1 (2-coloured, 100% Polyester)	5040244	4549,-
Leather 2-coloured	5040206	5229,-
Front panel mounted, Basalt decor	5040280	249,-
Drawer mounted, decor bas	5040290	669,-

Weekender for the entire width of the vehicle, centrally adjusted

③ Size 17: Total width 1380 mm - Upholstery width 1330 mm - Sleeping surface approx. 205x136 cm - Rail spacing 997 mm.

Fabric Classic (2-colour, 100% polyester)	5040300	4359,-
Fabric Bricks T6.1 (2-coloured, 100% Polyester)	5040342	4479,-
Fabric Double Grid T6.1 (2-coloured, 100% polyester)	5040344	4599,-
Leather 2-coloured	5040306	6489,-
Front panel mounted, Basalt decor	5040380	249,-
Drawer mounted, decor	5040390	679,-

Stainless steel swivel table support

mounted on front panel (without table top)	571300M	317,90
--	----------------	---------------

You will find further bench seats for vehicles with side plastic panelling or for right-hand drive vehicles at www.reimo.com/Ausbaushop.

VARIOTECH®3000

Movable in Reimo Grizzly rails

For Mercedes Vito long

For vehicles without side plastic trim

- 3 person sleeping/seating bench sliding and removable for empty vehicle without side panelling
- Ready upholstered for 3 seats
- 3 integrated, retractable head restraints and 3 seat belts
- Isofix attachment points for a maximum of 2 child seats (middle seat not usable when using a child seat)

Size 8: Total width 1155 mm - Upholstery width 1105 mm - Sleeping area approx. 195x126 cm - Rail spacing 700 mm.

Fabric Classic Grey (2-coloured, 100% polyester)	5045000	4359,-
Fabric Mercedes Caluma (2-coloured, 100% Polyester)	5045060	4549,-
Fabric Mercedes Tunja (2-coloured, 100% Polyester)	5045050	4549,-
Leather 2-coloured	5045006	6268,90
Front panel mounted, decor basalt	5045080	249,-
Drawer mounted, decor bas	5045090	639,-

Size 14: Total width 1305 mm - Cushion width 1255 mm - Sleeping surface approx. 205x136 cm - Rail spacing 1050 mm.

Fabric Classic Grey (2-coloured, 100% Polyester)	5045200	4359,-
Fabric Mercedes Caluma (2-coloured, 100% Polyester)	5045260	4549,-
Fabric Mercedes Tunja (2-coloured, 100% Polyester)	5045250	4549,-
Leather 2-coloured	5045206	6339,-
Front panel mounted, decor basalt	5045280	249,-
Drawer mounted, decor bas	5045290	679,-

Size 17, adjustable in the middle: Total width 1380 mm - Upholstery width 1330 mm - Sleeping surface approx. 205x136 cm Rail spacing 1050 mm.

Fabric Classic Grey (2-coloured, 100% polyester)	5045100	4359,-
Fabric Mercedes Caluma (2-coloured, 100% Polyester)	5045160	4549,-
Fabric Mercedes Tunja (2-coloured, 100% Polyester)	5045150	4549,-
Leather 2-coloured	5045106	6339,-
Front panel mounted, decor basalt	5045180	249,-
Drawer mounted,	5045190	679,-

Stainless steel swivel table support

mounted on front panel / drawer (without table top)	571300M	317,90
---	---------	--------

Grizzly" slide rail set for Variotech® 3000

2 pieces, Grizzly rails, anodised aluminium Vito long, length 286 cm, 4 drive positions	58326	508,-
--	-------	-------

Fastening set "Grizzly" for the slide rails

Adapter for screwing the Grizzly rails to the floor assembly		
Rail spacing 700 mm, long wheelbase	58328	339,90
Rail spacing 1050 mm, long wheel	583282	185,90

Floor adaptation steel

for rail spacing 700 mm: Order 1 outer rail	58327	240,90
Order 1 inner rail	583271	290,40
for bar spacing 1050 mm: order 2 pieces, price per piece	58327	240,90

Base plates 3-piece, long wheelbase

Rail spacing	Décor ship's floor		Décor Quad		Décor Ticino	
	Item no	Price	Item no	Price	Item no	Price
700 mm	16807	419,-	16808	439,-	168070	419,-
1050 mm	168071	419,-	168081	439,-	1680710	419,-

X-Trem Insulator 18 mm. Requires 2 plates for short wheelbase and 3 plates for long wheelbase.	50009	22,99
--	-------	-------



Attention: New decor base plate, illustration not binding



Note:The Vito with existing seat mounting threads in the vehicle floor is required as the basis for the rail mounting. Adapter plates are screwed and glued onto these, to which the rails are attached. If the threads are not available, the rails can be fitted using a special adhesive process by a company equipped for this. An underbody reinforcement is always provided in the rear area. The rails allow 4 driving positions as well as additional single seats in the front area (depending on the distance to the furniture line).

Delivery of uncovered bench seats to specialist companies specially trained in upholstery is possible

You will find further bench seats for vehicles with side plastic panelling or for right-hand drive vehicles at www.reimo.com/Ausbaushop.

VARIOTECH®3000

Movable in Reimo Grizzly rails



Note: The rails are screwed and additionally glued with Sikaflex and the vehicle floor is reinforced with underbody supports. Special features is that there are two different rails in the attachment, one for outside and another for inside

The rails allow 3 driving positions as well as 1-2 additional single seats in the front area, depending on the distance to the furniture line. There are 4 possible rail positions in the vehicle, the benches sizes 8 & 10 listed here are for mounting on the right, bench size 17 is for mounting in the middle of the empty station wagon. If there is a heat exchanger in the rear, for positioning on the left in the vehicle and other upholstery combinations, a different article number is required in each case (specialist trade information folder)

Delivery of uncovered bench seats is possible to specialist companies specially trained in upholstery.

For Renault Trafic, Opel Vivaro B, Fiat Talento

For vehicles without side plastic cladding

- 3 person sleeping/seating bench sliding and removable Forempty left-hand drive vehicles without side panelling
- Ready upholstered for 3 seats
- 3 integrated, retractable head restraints and 3 seat belts
- Isofix attachment points for a maximum of 2 child seats (middle seat not usable when using a child seat)

Size 8: Total width 1130 mm - Cushion width 1080 mm - Rail spacing 673 mm

Fabric Kompo (2-colour, 100% Polyester)	5044150	4339,-
Fabric Classic Grey (2-colour, 100% Polyester)	5044400	4359,-
Fabric Black Patterned (2-colour, 100% Polyester)	5044440	4549,-
Leather 2-tone	5044406	5989,-
Front panel mounted, decor basalt	5044180	189,-
Drawer mounted, decor bas	5044190	679,-

Size 10: Total width 1205 mm - Upholstery width 1155 mm - Rail spacing 673 mm

Fabric Kompo (2-colour, 100% polyester)	5044050	4549,-
Fabric Classic Grey (2-tone, 100% polyester)	5044000	4359,-
Fabric Black Patterned (2-colour, 100% Polyester)	5044040	4549,-
Front panel mounted, Basalt decor	5044080	249,-
Drawer mounted, decor	5044090	679,-

Set of slide rails "Grizzly" for Variotech 3000® - Renault Trafic

2 pieces, Grizzly rails, anodised aluminium, 3 driving positions

KR, length 249 cm, rail spacing 673 mm	58128	419,-
LR, length 289 cm, rail spacing 673 mm	581285	589,-

Size 17, centrally adjusted: Total width 1380 mm - Pad width 1330 mm - Rail spacing 1020 mm

Fabric Kompo (2-colour, 100% polyester)	5044350	4659,-
Fabric Classic (2-colour, 100% Polyester)	5044300	4549,-
Fabric Black Patterned (2-colour, 100% Polyester)	5044340	4659,-
Leather 2-tone	5044306	6489,-
Front panel mounted, decor basalt	5044380	249,-
Drawer mounted, decor bas	5044390	379,-

Set of slide rails "Grizzly" for Variotech 3000® - Renault Trafic

2 pieces, Grizzly rails, anodized aluminium

KR, length 249 cm, rail spacing 1020 mm	581280	460,90
LR, length 289 cm, rail spacing 1020 mm	581288	614,90

Stainless steel swivel table support

mounted on front panel (without table top) 571300M 317,90

Fastening set "Grizzly" for the slide rails

Adapter for screwing the Grizzly rails to the base assembly

Rail spacing 673 mm, combi KR/LR	58133	218,90
Rail spacing 1020 mm, Kombi KR/LR	58135	236,41

Floor reinforcement steel for rail spacing 673 mm

1x floor support front	581251	196,90
1x rear shelf support	581252	339,90

Floor plate, 3-parts, rail spacing 673 mm

Wheelbase	Décor ship's floor		Décor Quad		Décor Tessin	
	Item no	Price	Item no	Price	Item no	Price
short	141142	434,-	141144	434,-	1411420	434,-
long	141143	433,-	1411441	434,-	1411430	434,-

Floor plate 3-parts, rail spacing 1020 mm

Wheelbase	Décor ship's floor		Décor Quad		Décor Tessin	
	Item no	Price	Item no	Price	Item no	Price
short	141146	434,-	141147	434,-	1411460	434,-
long	141148	434,-	141149	496,-	1411480	465,-

X-Trem Isolator 18 mm. Requires 2 plates for short wheelbase and 3 plates for long wheelbase. 50009 22,99

You will find further bench seats for vehicles with side plastic panelling or for right-hand drive vehicles at www.reimo.com/Ausbaushop.

VARIOTECH®3000

Movable in Reimo Grizzly rails

For Ford Transit Custom

- For vehicles without side plastic cladding
- 3 person sleeper/seat bench sliding and removable Forempty left-and drive vehicle without side panelling
- Ready upholstered for 3 seats
- 3 integrated, retractable head restraints and 3 seat belts
- Isofix attachment points for a maximum of 2 child seats (middle seat not usable when using a child seat)

Size 8: total width 1155 mm - cushion width 1105 mm - rail spacing 766 mm

Classic Grey fabric (2-tone, 100% polyester)	5042100	4359,-
Fabric Luxe/Trend (2-colour, 100% polyester)	5042160	4549,-
Leather 2-colour	5042106	6289,-
Front panel mounted, decor basalt	5042180	189,-
Drawer mounted, decor bas	5042190	679,-

Size 10: Total width 1205 mm - Upholstery width 1155 mm - rail spacing 766 mm

Fabric Classic Grey (2-colour, 100% polyester)	5042000	4249,-
Fabric Luxe/Trend (2-colour, 100% polyester)	5042060	4549,-
Leather 2-colour	5042006	6289,-
Front panel mounted, Basalt decor	5042080	249,-
Drawer mounted, decor bas	5042090	679,-

Stainless steel swivel table support mounted on front panel (without table top)	571300M	317,90
---	---------	--------

Grizzly" slide rail set for Variotech® 3000

2 pieces, grizzly rails, anodised aluminium, single seat possible.
Length 249 cm, 3 driving positions

581960	537,64
--------	--------

Fastening set "Grizzly" for the slide rails

for screwing plus bonding with Sikaflex (not included in delivery).
Consists of: 2 floor adapters, underfloor reinforcements, screw set
rail spacing 766 mm, Kombi KR

58193	515,90
-------	--------

3-piece base plate, rail spacing 766 mm

	Décor ship's floor		Décor Tessin	
Short Wheelbase	Item no	Price	Item no	Price
	105230	399,-	1052300	435,-

X-Trem Insulator

18 mm. Requires 3 plates.

50009	22,99
-------	-------



Bed extension not included, to be ordered on request.



Note: As a basis for the rail fastening, the version of the Kombi with existing seat fastening threads is required. The rails are screwed and glued with Sikaflex, additional reinforcements are installed underfloor. There is only one rail constellation with the rail spacing of 766 mm symmetrical.

Delivery of uncovered benches to specialist companies specially trained in upholstery is possible.



Décor ship's floor



Décor Tessin



Scan the QR code to see the video of Variotech 3000.

You will find further bench seats for vehicles with side plastic panelling or for right-hand drive vehicles at www.reimo.com/Ausbaushop.

SAFETY BELTS

2-point lap belt and 3-point safety belts

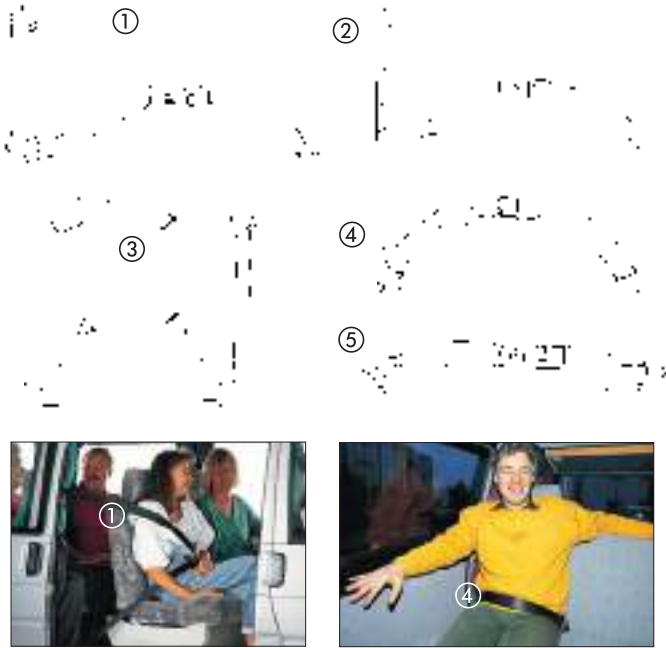

- ① **3-point automatic safety belt, universal use.**
Belt length 4 m, can be shortened. Locking belt adjustable from approx. 35 - 60 cm
Incl. fastening screws and small parts **58151 56,91**
- ② **3-point automatic safety belt for Variotech benches 3000**
Automatic belt, if the belt pulley has to be mounted vertically.
Belt length 4 m, lock belt approx. 20 cm. Incl. fastening screws and small parts **58118 54,99**
- ③ **3-point special safety belt. If a row of furniture is fitted between the upper belt point and the seat**
Belt length 3.6 m. 2 belt whips adjustable in length, approx. 30 - 60 cm. Incl. longitudinally adjustable lap belt adapter. Necessary if the 3-point belt cannot be used in a driving position. Incl. fastening screws and small parts **58150 81,90**
Same as ③, but with belt reel to be mounted horizontally for retrofitting the 3rd seat belt e.g. for family benches T5 **58149 97,90**
- ④ **Lap belt extra long for the middle seat in case of car registration, for vehicles with first registration before 2005; or in case of motorhome registration, 2 x per bench (outer seats), if no 3-point belts can be used on the outside (e.g. in panel vans).** Belt length 150 cm with adjustable lock belt from 30 - 60 cm **58152 27,91**
- ⑤ **Automatic pool belt with adjustable lock belt**
Belt length 150 cm, buckle belt from 30 - 60 cm **58153 39,90**

Accessories seat belts

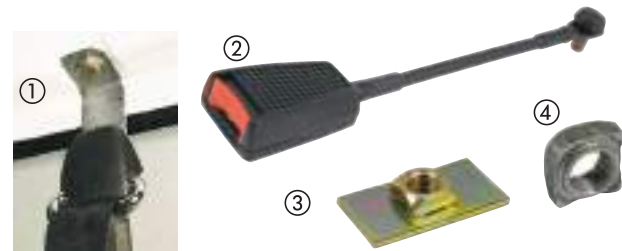

- ① **Seat belt suspension**
For mounting the seat belt centrally above the rear window, standard, cranked for VW T4 **58050 17,50**
straight, VW T5 **58051 17,50**
- ② **Belt whip for S-seats VW T4**
(driver or passenger side) required for retrofitting of swivel consoles in the VW T4. **58046 24,89**
- ③ **Threaded plate 60 x 30 mm**, to weld in threads for seat belts at points provided by the vehicle manufacturer **58052 5,80**
- ④ **Weld-in nut with fine thread** **58045 2,95**

Seatbelt adoptions for VW T5 panel van from 3/06 onwards

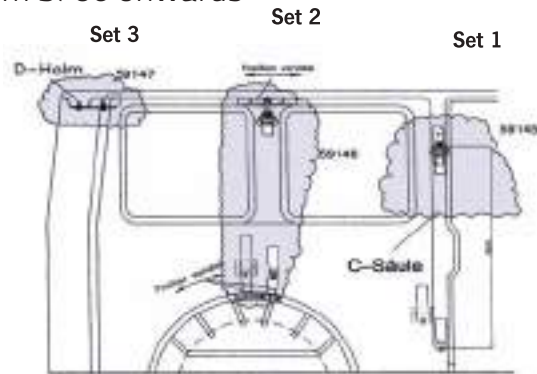

- For 3-point belt
For retrofitting the belt anchorage points on the VW T5 panel van
Suitable for short and long wheelbase
Delivery without belts, suitable for 1 side
- Set 1:** on the C-pillar on the left or right **59145 36,60**
 - Set 2:** above the rear wheel arch left or right **59146 200,88**
 - Set 3:** at the D-spar top in connection with the belt **58149 97,90**
 - 59147 66,31**





S2 - The sleeping bench for all cases

For Mercedes V-Class from 2014, Citroën Spacetourer/Jumpy from 2016, Peugeot Traveller from 2016, Opel Zafira from 2019, short and long wheelbase

- Adjustable headrests
- Individually adjustable backrest
- Integrated bed function
- Integrated ISOFIX system
- Low weight

For use in the passenger compartment, suitable for the original rail system, with integrated belt system (basis: ASBC)
Standard equipment: 2 seats, 3-point seat belts, adjustable head restraints, individually + continuously adjustable backrest, ISOFIX mount, ASBC system.
Approval ECE N1



Dimensions & Weights:

Total width: 1000 mm
Total depth: 800 mm
Total height (incl. belt frame + headrests): 1115 mm
Seat width: 500 mm
Seat depth: 500 mm
Total lying surface: approx. 1800 x 1000 mm
Lying surface single seat: approx. 1800 x 500 mm
Weight: kg 59
Longitudinal adjustment = rail
No lateral seat adjustment
Backrest inclination (forward | backward): + 15 | + 90
Headrest adjustment 70 / 60 mm

S2 Sleeping bench	59656	2175,08
--------------------------	--------------	----------------

Accessories:

Leg rest S2 Sleep bench	59657	639,73
Adapter for rails PSA	59658	633,33
Adapter for rails MB Vito/V-Class	59659	383,83



SITTING / SLEEPING BENCHES



Motorhome homologation according to StVZO 76/115/ ECE according to manufacturer

Divan 502 bench can also be used against the direction of travel

Bench Divan 502 - cosy bench seat

Cosy bench for 2 persons. Bench width approx. 90 cm. Can also be mounted against the direction of travel. The inclination of the backrest is adjustable. **Please note:** The installation in vehicles must be approved by the TÜV. We therefore recommend that you consult your local TÜV office before installation.

Suitable for Sprinter, LT, Ducato, Renault and other vehicles. Installation of two lap belts possible.

Scope of delivery: Pre-assembled bench with foam and covers, fully upholstered
Technical info Divan Bench: The Divan Bench 502 is without seat belts and intended for the front position against the direction of travel. Features: High quality high density foam. High quality upholstery fabric. Sturdy tubular steel frame. Additional storage space under the seat. Can be installed on a base plate or directly on the vehicle floor (with or without rubber mat). Seat width approx. 96 cm, seat height approx. 52 cm. Total height approx. 125 cm, total depth approx. 90 cm. Sleeping surface approx. 96 x 194 cm. Widening (approx. 30 cm) possible. Plinth height approx. 21 cm can be used as storage space.

Operating lever backrest right 59232 1445,-

Control lever backrestleft (useful for bench installation against driving direction) 59234 1445,-

Wood trim, anthracite for seat frame 59221 164,90



Motorhome homologation according to StVZO 76/115/ ECE according to manufacturer

Divano 506 bench can also be used against the direction of travel

Divano bench 506

The Divano bench 506 is equipped with a belt retainer and 2 three-point automatic belts. Displacement to the front and side possible. (lateral shift 27 cm, to the front 17 cm)

Features: High quality high density foam. High quality upholstery fabric Sturdy tubular steel frame.

Dimensions: Seat width approx. 90 cm, seat height approx. 48 cm. Total height approx. 129 cm, total depth approx. 63 cm. Widening (approx. 27 cm) possible. Base height approx. 20 cm, can be used as storage space.

Scope of delivery: pre-assembled bench with foam and covers, fully upholstered. With sliding device to the front and to the side.

Divano 506 with belt support and 2 three-point safety belts.

Operating lever on the right 59236 2238,-

Control lever left (useful for bench installation against driving direction) 592361 2238,-



Motorhome homologation according to StVZO 76/115/ ECE according to manufacturer

SK7 bench seat system - Extend your sleeping area into the cab

The solution if you want to make full use of the space.

Turn the driver or passenger seat around, fold out the SK 7 bench and you have a comfortable bed with a length of 190 cm. During the day it is a comfortable seat for 2 persons with 2 integrated three-point belts. The sleeping surface can be widened to 120 cm by means of a transverse sliding device and additional upholstery. Adjustable inclination of seat surface and backrest for individually adapted seating comfort.

Suitable for Sprinter, LT, Ducato, Renault and other vehicles.

Fixed bench seat with 2 integrated three-point belts attached to a rigid belt post. Bed is formed from 1 bench, With transverse sliding device for bed widening up to 1.20m. TÜV confirmation for motorhome approval is supplied by the manufacturer.

Technical information SK 7: Installation in the vehicle on floor plate (with or without insulation) .With insulated floor plate, the area of the belt crossbar must be underpinned with wood.

Dimensions: Seat width 950 mm, seat height ca.. 590 mm. Total height ca. 1250 mm Total depth approx. 900 mm. Sleeping surface ca. 960 x 1880 mm. Widening by approx. 200 mm possible. Plinth height ca. 210 mm (can be used as storage space).

Scope of delivery: Pre-assembled bench on mounting bracket, fully upholstered with foam and covers, incl. 2 three-point belts. With transverse sliding device for bed widening up to 1200 mm (without additional upholstery). Upholstery grey

Left-hand drive 59240 2967,21

Right-hand drive 59225 2899,-

Additional cushion for SK7 bench system (59240) to cover the Bed extension 59241 239,50

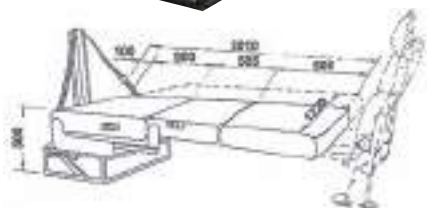

SITTING / SLEEPING BENCHES



Seat/sleeper bench

Upholstery can be folded down to form a bed.
 Bed size: 1870mm x 1000mm
 One side armrest.
 Adjustment of the backrest by means of sliding rails Cross rail (lateral shift) to widen the bed.
 Motorhome homologation according to StVZO 76/115/EG according to manufacturer, status 2005/41/EC

Seat-sleeper bench
 with integrated 3-point safety belts **59242 3706,-**



Euroseat A400 - TÜV approved, with integrated three point belt for Vaiotech 3000

Fabric Renault Traffic Black Patterned/Black:
 seatbelt buckle right side **59363 1349,-**
 Seatbelt buckleleft side **59364 1399,-**

Fabric Mercedes Tunja/Black:
 Seatbelt buckle right side **593626 1399,-**
 Seatbelt buckleleft **593627 1399,-**

Fabric Classic Grey/Black:
 Seatbelt buckle right side **59371 1199,-**
 Seatbelt buckleleft, **59372 1199,-**

Base/adaptor is required for single seat A400 .
 The base is needed for the installation of the seat A400 in combination with the Reimo floor rail Grizzly.
 Suitable for Renault Traffic (e.g. 581280, 58128) and Mercedes Vito (e.g. 58326) with screwed floor rail **58194 396,79**



Pilot seat for the passenger compartment

With integrated 3-point safety belts. Different seat heights can be realised. Adjustable backrest, armrests and headrests. With M1 classification, suitable for installation in cars/motorhomes. Meets the current standards for safety, valid from 1.11.2014 ECE14, ECE17
 Design: Classic dark grey

Euro seat A 400 with 2 armrests (without seat base) Belt connection left **59372 1199,-**
 Belt connection right **59371 1199,-**

Seat bases in different heights incl. floor rail adaptation
 (you need 2 pieces: 1 right and 1 left base per seat)

Seat base height 23 cm (seat height 41 cm) left **59366 137,90**
 right **59365 137,90**

Seat base height 28 cm (seat height 46 cm) left **59368 137,90**
 right **59367 137,90**

Seat base height 33 cm (seat height 51 cm) left **59370 142,90**
 right **59369 142,90**

Aluminium slide rail, double row, for mounting one seat or several seats in a row.
 Per seat approx. 1 meter seat rail necessary Length 2,40 m **59379 376,-**
 Length 3,00 m **593791 458,99**

Special adhesive for bonding the floor rail to the body. At least 2 cartridges are required
 per meter of track length. Cartridge 600 ml **593795 28,91**

SINGLE SEATS / PILOT SEATS



Macaw Black/Grey

Pilot seat S 5.1

- With integrated headrest
- With ABE

Dimensions: height 92 cm, backrest height 82 cm, seat width with armrests 62 cm, seat depth 52 cm
Weight: approx. 17 kg

S 5.1 Atlantic Blue		
592053	496,-	
S 5.1 Ara Black/Grey		
592055	496,-	
S 5.1 Leather Dark grey		
59002	917,99	



Tavoc 2

Pilot seat S 6.1

- With height- and tilt-adjustable headrest
- With ABE

Dimensions: height (incl. headrest) 96-106 cm, backrest height (incl. headrest) 79-90 cm, seat width with armrests 62cm, seat depth 52 cm
Weight: approx. 18 kg

S 6.1 Tavoc 2 Grey/Black		
592103	564,-	



Pilot seat S 8.1

- Distinctive side guides and soft foam parts
- Quick backrest adjustment
- Height-adjustable armrests
- With ABE
- With height and tilt adjustable headrest and pronounced side guides.

Dimensions: height (incl. headrest) 94-105 cm, backrest height (incl. headrest) 79-90 cm, seat width with armrests 62 cm, seat depth 53 cm, weight: ca. 18 kg

S 8.1 Tavoc Black/Grey		
592131	564,-	
S 8.1 Ara Black/Grey		
592132	564,-	



Atlantic Blue

Pilot seat S 9.1

- Distinctive side guides and soft foam parts
- Quick backrest adjustment
- Height-adjustable armrests.
- With ABE

With integrated headrest. Backrest height and headrest according to new EC standard

Dimensions: Height 92 cm, backrest height 82 cm
Seat width with armrests 62 cm, seat depth 53 cm. Weight: ca. 18 kg

S 9.1 Atlantic Blue		
592144	518,99	
S 9.1 Tavoc 2 Grey/Black		
592145	518,99	
S 9.1 Ara Black/Grey		
592146	518,99	



Attention:

Sportscraft seats may be used in Germany for motorhomes and cars. Outside Germany, the use must be clarified with the regional TÜV. For new vehicles from season.2022 please clarify the approval regarding the seat recognition with the TÜV.



Macaw Black/Grey

Pilot seat S 10.1

- Armrests integrated into backrest - creating a larger passageway into the living area with maximum seat width
- Quick adjustment of the backrest in segments of >2°
- With seat tilt adjustment at the front
- With integrated headrest

S 10.1 Tavoc 2 Grey/Black			S 10.1 Macaw Black/Grey		
Fs*	594054	959,-	Fs*	594056	959,-
Bfs**	594055	959,-	Bfs**	594057	959,-

*Fs: driver side, **Bfs: passenger side

Accessories for Sportscraft van seats

Seat heating	59165	231,40
Lumbar support	591651	31,88

Please order with new order, as not retrofittable.



MagicComfort MSH 300 - Seat heating made of carbon

- Easy installation
- Super fast and adjustable heating
- 3 heating levels from 10 to 70 Watt
- Carbon heating elements can be cut to size

Seat inserts with carbon heating for the driver and passenger seat, heat up quickly and provide immediate warmth. Easy operation by ergonomic push button with LED display
Input voltage (DC) 12 V, rated input power (DC) 140 W, power consumption 140.00 W, dimensions: W 270 x H 580 x D 2 mm. Weight: 1,32 kg
4 pieces **59006 289,-**

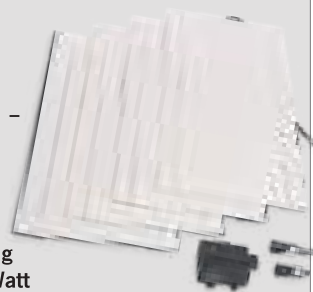

3-POINT BELT SUPPORT FOR DUCATO, BOXER, JUMPER

Universal belt supports for 2 persons

Tested in the vehicle (homologation) for Fiat Ducato and similar vehicles. Tested in the vehicle according to ECE R14.06/07.

An acceptance at the TÜV according to § 21 (single acceptance) is necessary. A prior clarification of the mounting situation in the vehicle with the TÜV is recommended.

The belt supports are positioned on the side member of the vehicle, in longitudinal direction the position is variable. They are fastened by means of screw connections through the vehicle floor. The weight of the belt trestle without fastening parts is in each case between 12.5 and 13.5 kg. Supplied complete with fastening material and safety belts

Available in 3 different basic types:

① Type 1: For Fiat Ducato X250/X290 panel vans/station wagons: Seatbelt kit normal	59101	449,14
② Type 2: For Fiat Ducato X250/X290 chassis with high ladder frame: Belt support kit normal	59103	469,68
Belt support kit raised (83 mm higher)	59515	470,28
③ Type 3: For Fiat Ducato X250/X290 chassis with flat frame: Belt support kit normal	59102	479,83
Belt support kit raised (83 mm higher)	59516	479,22

Headrests for this are in preparation, see www.reimo.com



Belt support for Ducato, Boxer, Jumper

- For retrofitting in motorhomes Fiat Ducato, Peugeot Boxer, Citroën Jumper
- With automatic 3-point seat belts (suitable for child seat)
- Belts are concealed in the pillar, no twisting possible
- Cantilever construction without cross-braces preserves the storage space in the stowage box
- Tested in accordance with applicable EC directives on rigid plate
- Previous seat continues to be used, installation requires registration
- With expert opinion for M1 motorhomes: Acceptance according to § 21 necessary.
- Attachment to vehicle floor: **Not included in the scope of delivery. (Please clarify installation with your local TÜV)**

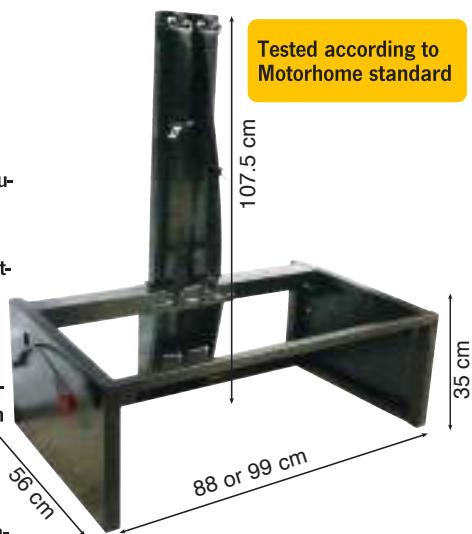

Dimensions: W 99 x D 56 x H 107,5 cm, seat height without support: 35 cm, weight approx. 4 kg **59560 899,-**

Dimensions: W 88 x D 56 x H 107,5 cm, seat height without support: 35 cm, weight approx. 40 kg **59561 899,-**

Tested on the rigid plate according to regulation 76/115 status 96/38 and 2005/41. Acceptance according to § 21 (individual acceptance).

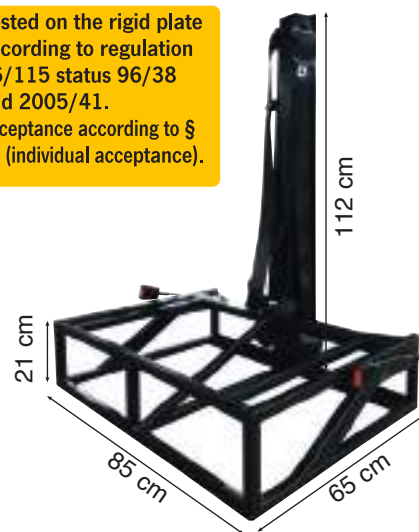

Underframe Divano 505, incl. 2x 3 point safety belt

5 hexagonal bolts M12 UNI5739 are recommended for fixing to the floor.

Seat height without support: 21 cm, weight approx. 28,6 kg **592360 572,90**

3-POINT BELT SUPPORT



Picture shows universal belt support 595010 with pad 595005 in Fiat Ducato

General type approval (ABE)



An ABE is a permit that is usually attached to parts that are particularly easy to install. It is assumed that the buyer himself cannot do much wrong when fitting these parts (usually e.g. rims, etc). Therefore, after performing the modification on the vehicle with this part, no further action is

necessary. The vehicle operating permit remains intact and the vehicle can continue to be used

However, it must be ensured that all instructions and requirements from the ABE are adhered to. The ABE papers must be carried at all times during every journey. On request, the information from the ABE can often also be entered in the vehicle documents, so that the ABE no longer has to be carried separately.

TÜV parts certificate A TÜV parts certificate is the most common form of approval for tuning parts. The parts certificate contains precise instructions and conditions. In order to avoid incorrect installation of tuning parts or incorrect modifications, the vehicle must be presented to a TÜV inspector after the modification. Here, not only the conformity of the certificate with the corresponding part and also the corresponding vehicle type / model is checked, but also the quality of the modification.

The vehicle operating permit expires temporarily directly after the conversion until the conversion has been "registered". Only the direct way to the TÜV test center may still be undertaken with the vehicle

The TÜV inspector issues a certificate - an entry according to StVZO §19.3. With this certificate, the modification can then be entered in the vehicle documents at the registration office. For motor vehicles that had their initial registration before 1.1.1992, there are no special requirements for modifications to the seat console or seat rails.

In addition, safety belts were not yet mandatory for motorhomes first registered before 1.1.1992. Therefore, no test is mandatory for the installation of swivel bases in these older vehicles. From the first registration on 1.1.1992, at least an expert opinion according to 76/115 EWG (Europe-wide ECE R14) must be available when changing the seat structure for approval according to STVZO.

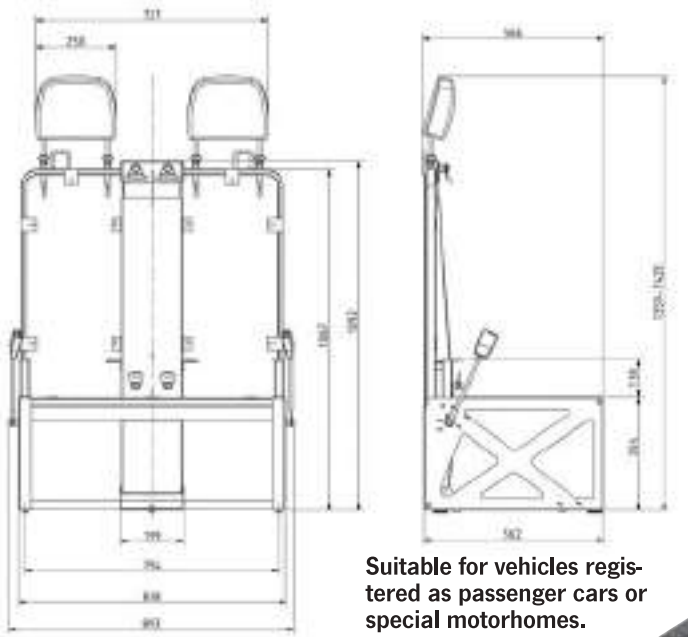

Suitable for vehicles registered as passenger cars or special motorhomes.

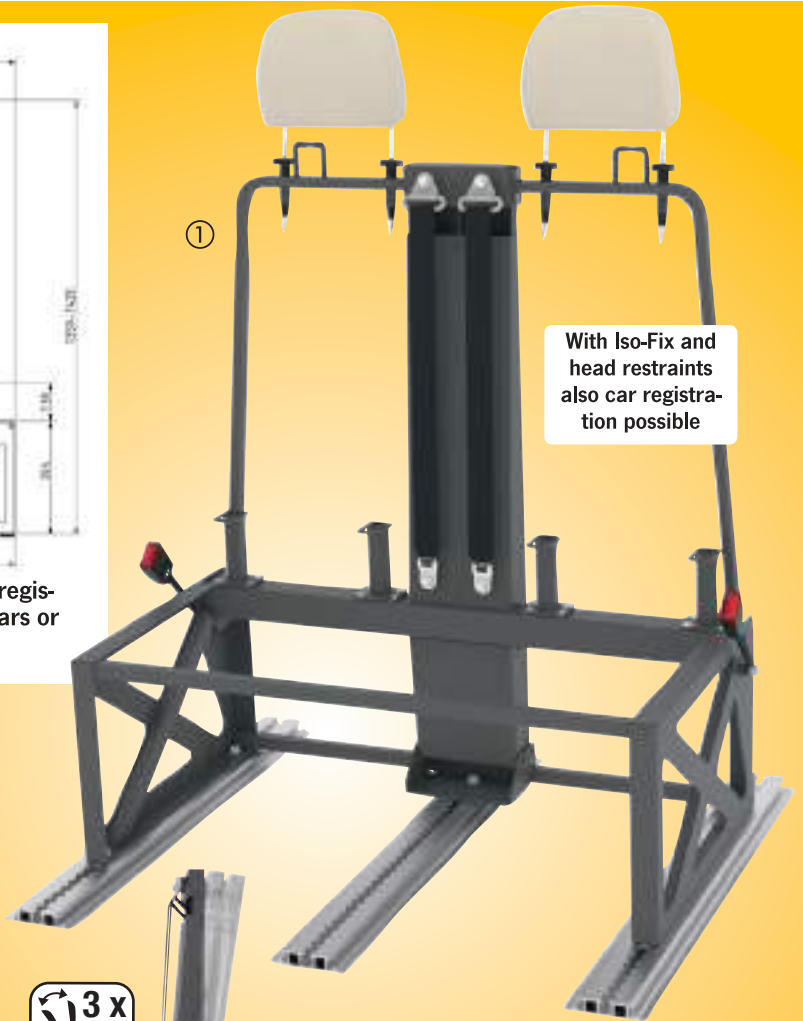

Universal belt trestle for flexible installation

Modularly constructed belt trestle for 2 persons with integrated three-point belts and Isofix child seat holders, expandable with tested head restraints. For better seating comfort, the backrest can be mounted at a slight angle. An optional raising kit is available for vehicles with a height jump to the cab or platform. The belt support is installed in the vehicle by means of three aluminium rails and can therefore be easily removed again if required. The aluminium rails are glued to the vehicle floor and additionally screwed in the rear area.

A certificate of testing according to ECE R14.07 (seat belt anchorages), ECE R17 (seat strength) and ECE R16 is enclosed.

It documents the test in the Ford Transit and refers to the fact that the tests can be transferred to other vehicles. ("the results are representative also for other types of vehicles").

We recommend that the installation situation is clarified in advance with the responsible TÜV

① 3-point belt support 900mm, steel, with adjustable backrest in 3 positions

Scope of delivery: belt stand, 2 three-point belts, Isofix brackets, backrest with bracket for headrests
595010 953,20

② Raising kit for additional 120 mm height

595002 93,11

③ Seat cushion, supplied with cover and two headrests

595005 553,-

Installation kit consisting of:

3x aluminium profiles length 1250 mm each, fixing material for profiles, adhesive

595006 361,34



SWIVEL CONSOLES for VW Transporter

For VW T5/T6

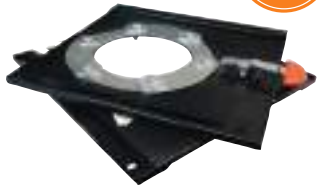

Without TÜV

For original seat FS/BFS from 2003 onwards
59699 143,20

Matching handbrake lowering
necessary for swivel console driver's side
59616 35,95



Without TÜV

For original seat from 2003
• With safe
Driver's side/passenger's side
59647 458,99

Matching handbrake lowering
necessary with swivel console driver's side
Left hand drive 596471 21,96

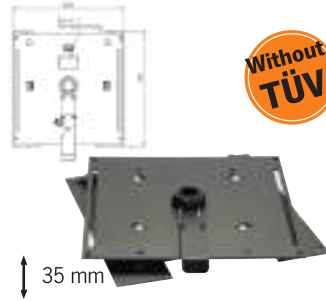

Without TÜV

For original seat FS/BFS from 2003 onwards
If original battery is installed
59502 245,-

Suitable handbrake lowering
necessary with swivel console driver's side
Left hand drive 59616 35,95
Right hand drive 596160 35,95

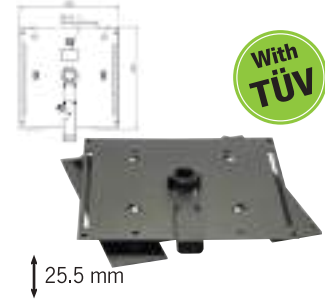

With TÜV

Swivel console from year 2003
Installation only if there is no battery under the seat. Driver's side incl. handbrake lowering

59498 259,-
Passenger side 59499 239,-



VW T5 for original double bench seat
My. 2003-2015, only for right-hand drive
Test number: 76/115/EEC.
Dimensions in mm: L 605 x W 406 x H 229 (without screws)
594961 554,94



With TÜV

VW T5 for original double seat bench
My. 2003-2015
With parts certificate. Without cable gland.
59496 539,-



Without TÜV

For Sportscraft seats from 2003 -
• With Safe
incl. slide rails and adapter. Driver's side 59648 659,-
Passenger side 596481 659,90



Without TÜV

Adapter Sportscraft seat from year 2003 onwards
Incl. slide rails For mounting Sportscraft seats on original or swivel consoles
596451 299,-



Without TÜV

Seat base for original seat from 2003 onwards
Height adjustable: 230 - 360 mm,
Driver's side 59650 675,-
Passenger side 596501 675,-



With TÜV

Swivel console for original seat from 2003 onwards

- No increase of the seat height
- Rotation of the seat possible even with the door closed

With mounting material incl. handbrake lever adapter. TÜV tested with parts certificate. Locking in driving direction or also in 180° position possible. Handbrake lever can be mounted individually. Outer dimensions: 430 x 430 x 210 mm. Weight approx. 17 kg.

Driver's side 59593 287,29
Passenger side 59594 265,93



NEW 2022

Swivel console for VW T5/T6
For battery installation. Height 250 mm
driver's side 59538 404,77
Passenger side 59544 372,72

For VW T4



With TÜV

Swivel console for original seat year 1996-2003
Driver's side 59471 178,30
Passenger side 594711 178,30

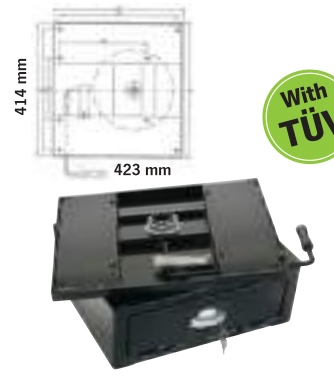

With TÜV

Swivel console for My. 1996-2003 incl. safe
Driver's side/passenger's side 59512 429,-

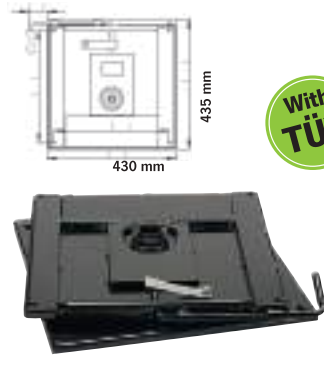

With TÜV

Rotating console original seat + Sportscraft for Bj 1996-2003
Rotating in the middle, with cable gland
Driver's side/passenger's side 59501 259,-

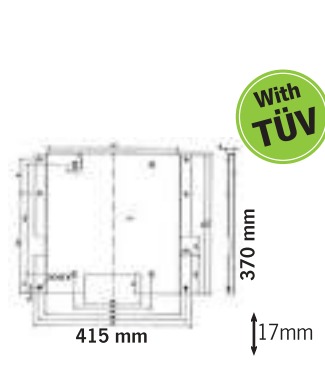

With TÜV

Adapter for Sportscraft seat on swivel base 59501.
Original rails required.
59510 143,-

REVOLVING CONSOLES for mini campers and vans

For VW T4 until 1996



Without TÜV

+



Without TÜV

Rotating console

Rotating in the middle for Driver/passenger side. Belt whip (No. E5487) must also be ordered.

59511 254,-

Belt whip

for swivel console 59511
Bolts to seat box.

E5487 49,94

For VW T3 My. 1979-1992



Without TÜV



Without TÜV

Rotating base for original seat

For T3 first registration before 1.1.1992 no TÜV necessary, from 1.1.1992 at least a certificate according to 76/115 EWG (Europe-wide ECE R14) must be available

59500 265,-

Adapter f. Sportscraft seat

For T3 first registration before 1.1.1992 no TÜV necessary, from 1.1.1992 at least a certificate according to 76/115 EWG (Europe-wide ECE R14) must be available

59503 129,-

For Citroën Jumpy/Peugeot Expert as of 2016

With TÜV



Swivel bracket for original seat

Driver's side	595881	358,-
Passenger	595882	309,-
Handbrake cover	595889	17,-

Swivel console for original seat

Driver's side	595883	336,42
Passenger side	595884	336,42
Handbrake lever adapter	595885	43,68

Swivel consoles tested in conjunction with the electrically adjustable seats of:

- Toyota Proace/Proace Verso, - Citroën Jumpy Space Tourer, - Peugeot Expert/Tourer/Vivaro/Zafira Live

- Low construction
- Large cable gland
- Low weight (approx. 9,4 kg)
- Assembly friendly
- Tested according to M1/N1

NEW 2022



Driver's side	59008	289,-
Passenger side	59009	289,-
Handbrake lowering	59010	44,90

For Renault Trafic II / Opel Vivaro A My. 2001 until 2014

Without TÜV



For double seat
594960 548,99

Without TÜV



For original seat
Driver's side 59570 205,-
Passenger side 595701 205,-

For Renault Trafic III / Opel Vivaro B as of year 2014

With TÜV



For original seat
Driver's side 59585 249,-
Passenger side 59586 229,-

Without TÜV



For original seat
Passenger side 594721 296,70

For Ford Custom/Tourneo

With TÜV



Swivel console V362
Driver's side 59587 229,-
Passenger side 595870 229,-



Handbrake lowering V362 for driver's side
595871 23,95

For Ford Transit

With TÜV



470 mm

480 mm

Fig. shows swivel console for driver's side

Swivel bracket for mounting between original seat box and Ford slide rails, year 2004 - 2012 (Only for vehicles with handbrake left)

Driver's side	59529	319,-
Passenger side	595291	299,-

For Ford Transit/Tourneo

With TÜV



480 mm

470 mm

Swivel bracket from year of construction 2004 for Sportscraft seat

Mounting with slide rails (please order no. E3092)

Driver's side	E3091	285,-
Passenger side	E3256	285,-



Slide rail for longitudinal adjustment for E3091
E3092 285,-

SWIVEL CONSOLE for Maxicamper

For Mercedes Vito/Viano

		
Swivel console for Vito original seat year 1996 to 2003	Swivel console for original seat MY 2004 to 2015	Swivel console for original seat from year 2015 onwards
Driver's side 594772 157,50	Driver's side 59598 229,-	Driver's side 59596 229,-
Passenger side 594773 157,50	Passenger side 59599 229,-	Passenger side 59597 229,-

For Mercedes Sprinter and VW LT

			
Swivel console for original seat My. 1996-2002	Swivel console for original seat year 1995 (LT 1996) until 2006	Swivel console for original seat side incl. handbrake lowering	Swivel console for original seat
incl. handbrake lowering		Driver's side 59633 269,95	Approval ECE-N1, no handbrake adapter necessary
Driver's side 59532 273,-	Driver's side 59476 215,-	Passenger side 59634 272,-	Driver's side 59643 383,41
Passenger side 59533 269,-	Passenger side 594761 215,-		Passenger side 59644 383,41

For Renault Master from MY 2004 to 2010





Swivel console for Sportcraft seat
Driver/passenger side: E2837 279,-

For Renault Master/Opel Movano

	
Swivel console from MY 2010 onwards	Swivel console for original seat, MY. 2004-2009, driver/passenger side
Driver's side 59588 229,-	59642 259,-
Passenger side 595880 229,-	

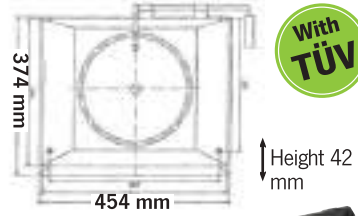
For Fiat Ducato Type 230/ Citroen Jumper / Peugeot Boxer

		
Swivel console My. 1995-2001	Low seat box year 1995-2001.	Adapter for Sportcraft seat
For original driver/passenger seat . 59546 309,-	To be mounted instead of the original seat box. To be installed only if there is no battery.	E9996 57,95
With adapter for Sportcraft seat driver/passenger. 59547 339,-	59579 199,-	



Universal swivel console for Sportcraft seat Seat fitting 59557 please also order. Installation and TÜV have to be clarified by yourself. 59556184,-



Seat fitting for Sportcraft seats
59557 68,90

SWIVEL CONSOLE for Fiat, Citroën, Peugeot

For Fiat Ducato type 244 / Citroën Jumper / Peugeot Boxer MY. 2002 - 2006



Swivel console for original seat
Mounting between underframe and slide rail. Driver/passenger side, rotating in the middle.
59572 219,-



Swivel console for original seat
Driver's side 59478 160,30
Passenger side 594781 160,30



Swivel console for original seat Mounting between underframe and slide rail. Rotating off-centre
Driver's side 59573 219,-
Passenger side 59574 219,-



Seat box flat
Instead of original box.
59545 189,-



Swivel console with adapter for Sportcraft seat Center swivel, driver/passenger side
59575 219,-

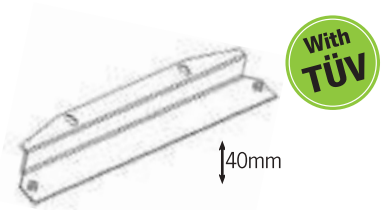

Flat adapter as replacement for original base
Thus 40 mm lower seat position than with original seat box.
For passenger side 59549 57,99

For Fiat Ducato type 250/290 / Citroën Jumper / Peugeot Boxer from MY. 2006 onwards



Swivel console for original seat
Driver's side 59473 211,90
Passenger side 594731 220,99

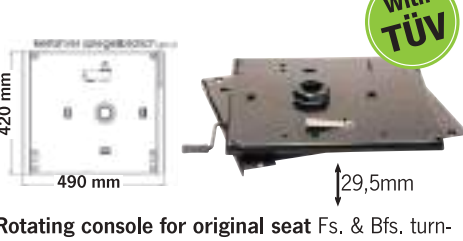

Rotating console for original seat Fs. & Bfs. turning in the middle
59581 239,-
Driver's seat, off-center turning 59583 239,-
Passenger, off-center rotation 59582 239,-



For Sportcraft seat mounting between base and slide rail
Fs. & Bfs. rotating centrally 59589 339,-
Driver's side, offset turning E4993 349,-
Passenger side, offset turning. E4863 349,-

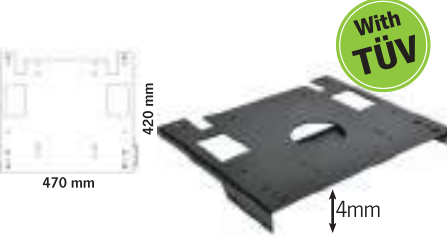

Standard adapter for Sportcraft seats.
59584 124,-

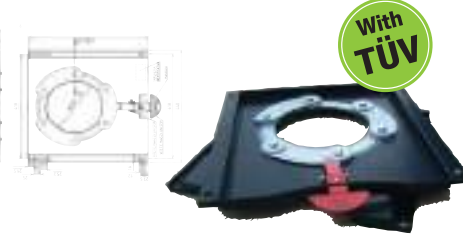

Swivel console for original seat FS/BFS
with test certificate according to e50
59698 127,95



Low seat box
Mounting instead of the original undercarriage if there is no battery under the seat. Ideal in combination with swivel console. This base is approx. 40 mm flatter than the original underframe
59548 229,-



Sliding rail set Sportcraft seat passenger
Fiat Ducato 2002 until 2012
E2838 109,-

Flat adapter for Sportcraft seat Fiat Ducato My. 83 to 02/06, driver/passenger side, for mounting between seat and slide rail.
59566 38,98

For Fiat Ducato type 250X from MY07/2006 onwards



Swivel console for original seat
Driver's side 594702 145,-
Passenger 594703 152,50



OVERVIEW OF THE SLEEPIN / BENCH-SYSTEMS

Welche Reimo Sitzbank passt für Ihr Fahrzeug (Die Ziffer im Kreis steht für die Fahrzeuglänge)										Fahrzeuglänge(Radstand) in mm							
Hersteller	Typ	Baujahr	baugleich	Family/Eco Ferribau	Reimo Variotech 3100* Festeinbau	Reimo Variotech 3000*	Reimo Variotech 1800 Einzelbau	Gurtbock 995016	Gurtbock 995012/3	Gurtbock 99515/16	Gurtbock 99250	Gurtbock 99500/61* starr montiert	Sitzbank SK7 99200, 99221 starr montiert	Fest Divan 906* starr montiert	①=L1	②=L2	③=L3
															4963(R3000)	5413(R3450)	L4:5998(R4035)
Citroen	Jumper II	2006-						①-③	①-③	②	①-③	①-③	①-③		4963(R3000)	5413(R3450)	L4:5998(R4035)
	Jumpy	2007-													4805(R3000)	5143(R3122)	-
Fiat	Ducato 250	2006-						①-③	①-③	②	①-③	①-③	①-③		4963(R3000)	5413(R3450)	L4:5998(R4035)
	Scudo	2007-													4805(R3000)	5143(R3122)	-
	Talento	2010-													4999(R3098)	5399(R3498)	-
Ford	Transit Custom	2013-		②											4971(R2933)		
	Transit	2001-2012													4863(R2993)	5230(R3300)	6403(R3750)
	Transit	2014-						①-③							5531(R3300)	5981(R3750)	6704(R3750)
Hyundai	H1	2008-												4685(R2800)	-	-	
Mercedes	Viano W447	2014-													4748(R3200)	5140(R3200)	5370(R3430)
	Vito W447	2014-													4748(R3200)	5140(R3200)	5370(R3430)
	Vito (W/V639)	2003-2014													4748(R3200)	4993(R3200)	5223(R3430)
	Viano	2003-2014													4748(R3200)	4993(R3200)	5223(R3430)
	Sprinter (NCV3)	2006-						①-③					①-③	①	5245(R3250)	5910(R3665)	6945(R4325)
	Sprinter (T1N)	1996-2006						①-③					①-③	①-③	4889(R3000)	5639(R3550)	6589(R4025)
Nissan	NV300	2014-													4999(R3098)	5399(R3498)	-
	Primastar	2001-2014					①								4782(R3098)	5182(R3498)	-
Opel	Vivaro X82	2014-													4999(R3098)	5399(R3498)	-
	Vivaro	2001-2014													4782(R3098)	5182(R3498)	-
Peugeot	Boxer II	2006-						①-③	①-③	②	①-③	①-③	①-③		4963(R3000)	5413(R3450)	L4:5998(R4035)
	Expert	2007-													4805(R3000)	5143(R3122)	-
Renault	Trafic X82	2014-													4999(R3098)	5399(R3498)	-
	Trafic	2001-													4782(R3098)	5182(R3498)	-
VW	T6	2015-		①②											4904(R3000)	5304(R3400)	-
	T5	2003-2015		①②			①②								4892(R3000)	5292(R3400)	-
	T4	1990-2003		①②											4707(R2920)	5107(R3320)	-
	Crafter	2006-						①-③							5245(R3250)	5910(R3665)	6945(R4325)

Bench fittings / Accessories

- ① **Special seat bench fitting VW T2/T3 My. 8/79-7/90**
With engine compartment elevation 12 cm to build a storage space above the engine compartment.
With 2 support brackets **58001 212,-**
- ② **Variotech special fitting:** Low overall height (approx. 60 mm). The fittings are completely covered by the upholstery in the sleeping position. Very stable design with or without lifting. We use this bench fitting in our Variotech bench system. TÜV tested according to ECE standard 14 and 17. Without lift for Variotech except VW T5/6.
Without lift **58007 139,-**
With lift **58012 160,-**
- ③ **Universal folding seat fitting**
For the construction of complete bench groups. 3 bench positions are possible with this fitting. With a few simple steps it is possible to convert a folding bench seat into a living area, driving or lying position.
Universal fitting short
for bench in driving direction **58005 152,-**
Universal fitting long. Due to its larger swivel range, this fitting bridges approx. 40 cm of free space. This makes it possible to build a bench seat with the long side directly against the vehicle wall.
58006 155,-
- ④ **Universal fitting,** high rear for Family bench seat **58015 339,99**
- ⑤ **Seat spring,** spare part for seat fitting. **58011 3,70**

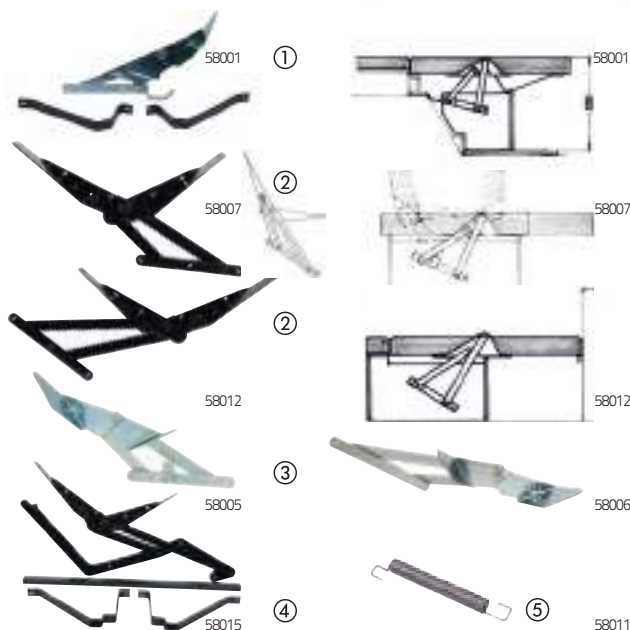

*Attention

Since October 2004 (for first-time registrations), three-point belts are required on all Three-point belts are necessary on all seats
Middle seats with lap belts are therefore only to be registered if the vehicle is registered as a special motorhome
The test was carried out without head restraints, as head restraints are not mandatory even for passenger cars on rear seats.

Note:

Every installed bench must be examined by the TÜV. For some vehicle types, our expert opinions also confirm that the bench is fixed in the vehicle (see above)
For other vehicles, an expert can approve the fastening in the vehicle analogously. Recommendation: This is easier if the installation is carried out according to our tested models. If in doubt, talk to your expert in advance.

REIMO VAN-CONCEPT

CONVERSION- MATERIAL

For all those who want to remove their vehicle themselves. Here you will find the right material. Whether furniture panels or other for furniture construction, everything for insulation, fabrics or windows to make your vehicle even more homely.

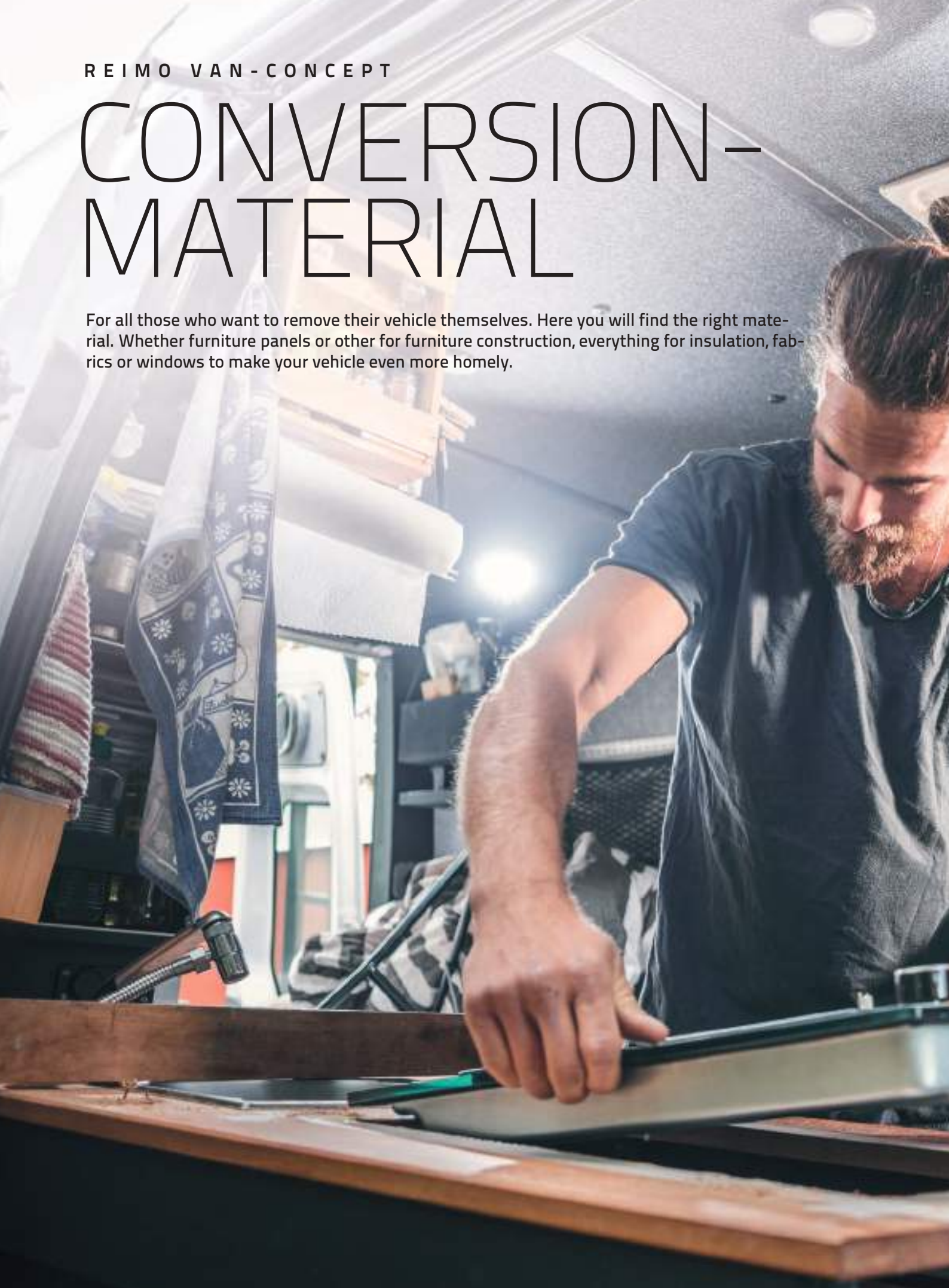



- CONTENTS -

NOISE INSULATION / ISOLATION	172-173
INTERIOR TRIM	174-177
FURNITURE PANELS	178-179
LIPPING / PROFILES / FLOOR PANELS	180-181
FURNITURE COMPONENTS.....	182-183
HINGES / TUMBLERS	184-185
FURNITURE HANDLES / LOCKS.....	186-187
VENTILATION GRILLES / HOOKS	188-189
ROLLER SHUTTER DOOR / PULL-OUTS.....	190-191
TABLE PEDESTALS / FEET / COLUMNS	192-195
FOAMS / VELCRO	196-197
AUTOMOTIVE UPHOLSTERY FABRICS	198-201
CURTAINS / DRAPES.....	202-203
WINDOWS + ACCESSORIES.....	204-215
ROOF HOVES.....	216-217
WINDOW POCKETS / TRIM.....	219



CARBEST
INNOVATIONS FOR MOBILE LIFE

**EXPERTEN
TIPP**
CAMPING-
BUSSE

Use in small strips to
reduce vibration

XTrem® Noise Regulator - self-adhesive sound insulation

- Odourless
- Heat reflecting, aluminium coated, 2 mm thick
- Without bitumen, not mixed with petroleum or asphalt
- Excellent sound insulation and noise reduction
- Self-adhesive with strong surface adhesion
- Processing possible from 5°C

Temperature resistant from -30°C to +80°C. Adhesive layer covered with protective film.

100 x 50 cm	GP 25,80/1 sqm	50098	12,90
500 x 40 cm	GP 18,95/1 sqm	50099	37,90

Please wear gloves to protect yourself from the sharp-edged film
Wear gloves.

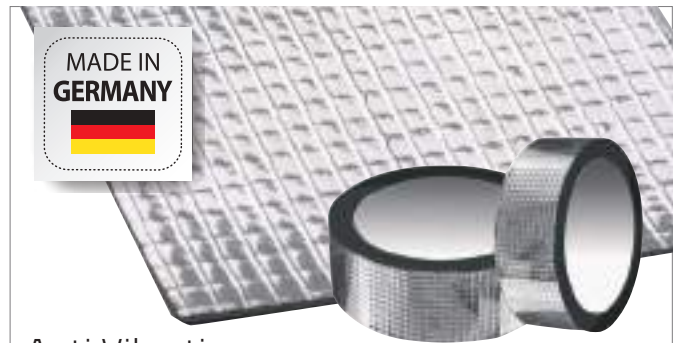

Anti Vibration Sound Insulation Mats DeLuxe

- Oil and fuel proof surface
- Ageing resistant
- Quick and easy installation, as self-adhesive
- Temperature stable up to 140 degrees
- Sheet size: 0.8 m x 1.2 m = 0.96 m²
- Thickness: approx. 4 mm
- Weight: approx. 4.1 kg/board (4.3 kg/m²)

The ideal product to insulate engine compartments in the medium power range when little space is available. The focus is on vibration damping. The installation is problem-free, because you simply stick the sheet goods on the walls in the engine compartment via the self-adhesive foil on the back. Can also be used as sound insulation. Ideally suited to reduce vibrations on the bodywork of panel vans. Installation on sheet metal, floor etc.

Aluminium adhesive tape

fabric reinforced 50 mm, 50 m length, thickness: 0,15 mm, 1 roll
GP 0,17/1 m **990163 8,50**



Acoustic fleece - perfect for uneven surfaces

- Good sound absorption, low weight
- Flame retardant according to DIN 4102 (B1)
- 100% PES, recyclable
- Compensates for unevenness of the boundary surfaces
- Thickness: approx. 40 mm

Soft and flexible acoustic fleece. The soft fleece adapts ideally to uneven surfaces, e.g. for lining cavities. Perfectly suitable for sound insulation of driving and wind noises

Dimensions: 50 x 100 cm GP 67,98/1 sqm **50008 33,99**



Sound insulation mats

- Surface sealed
- Quick and easy installation, because self-adhesive

Insulates driving and engine noises. Mat size: 1000 x 500 mm. Surface sealed: No moisture can penetrate. Insulating against heat and cold. Resistant to oil, water and petrol. Easy to work with a knife. Covered on the back with self-adhesive film. Set of 4 mats, thickness: 2 mm

GP 79,80/1 sqm **50021 39,90**



Special adhesive for X-Trem insulator

① Adhesive Macroplast

Universally applicable for bonding a wide variety of materials such as wood, various plastics, metals, felts, etc., both to each other and to each other. Macroplast B 2168 is not suitable for bonding polystyrene foam, PE, PP, PTFE and soft PVC.

650 g tin GP 36,14/1 l **50036 23,49**

Power spray adhesive

Bonding to wood, metal and plastics as well as X-trem.

② 400 ml, heat resistant up to 110°C
GP 42,47/1 l **500130 16,99**

③ 500 ml, heat resistant up to 80°C
GP 43,98/1 l **50013 21,99**

Reimo X-Trem Isolator®

REIMO
BEST PRICE
from **12,-**

EXCLU-

- Proven for over 30 years at Reimo
- X-trem insulator does not absorb moisture
- Extremely flexible (360°), fits optimally to the bodywork
- Does not squeak, has an anti-drumming effect, resistant to most solvents and high temperatures, largely harmless to building biology
- Made of closed-cell foamed polyethylene
- Highly heat-insulating (mountaineers sleep on ice with a mat thickness of 15 mm!)
- Extremely light (saves you quite a bit of fuel over time)



X-trem-Isolator® * Classic

Colour: Black. Panel size approx. 1 x 2 m, price per panel

Thickness 5 mm	GP 6,00/1 sqm	50020	12,-
Thickness 10 mm	GP 7,00/1 qm	50015	13,99
Thickness 15 mm	GP 9,99/1 sqm	50016	19,99
Thickness 18 mm			
(ideal for floor insulation)	GP 11,49/1 sqm	50009	22,99
Thickness 20 mm	GP 13,49/1 sqm	50017	26,99
Thickness 30 mm	GP 20,25/1 sqm	50018	40,50

Rolls approx. 20 mm thick. Price per running meter.
1.45 m roll width (approx.) GP 17,23/1 sqm **24,99**

X-trem-Isolator® self-adhesive*

• **Self-adhesive even more convenient to lay** Colour Black.
Heat resistant up to 120°, adhesive layer covered with protective foil.
Panel size approx. 1 x 2 m, price per panel:

Thickness 10 mm	GP 14,49/1 sqm	50000	28,99
Thickness 20 mm	GP 20,00/1 qm	50001	40,-

X-trem-Isolator® Soft*

-Further development of the proven X-trem-Isolator
-Non-slip, Odourless and significantly softer
Colour: Black. Sheet size approx. 1 x 2 m, price per sheet

Thickness 10 mm	GP 8,00/1 sqm	50095	15,99
Thickness 20 mm	GP 15,00/1 sqm	50094	29,99

X-trem-Isolator® Soft Self-adhesive

Thickness 10 mm	GP 13,99/1 sqm	50097	27,99
Thickness 20 mm	GP 20,00/1 qm	50096	40,-

Thermal conductivity value
X-trem-Isolator®
0,020-0,035

Extremely easy to process
(e.g. with blade knife)
The insulator does not tear,
does not fray and
does not fray)



Insulation materials in comparison	Thermal conductivity value, the smaller the better (W/M x K)	Diffusion resistance factor	Price factor to PY at 40 mm
X-trem isolator	0,020-0,035	vapor-proof	+ 4,0
Polystyrene	0,025-0,040	20-300	0
Polyuretan	0,025-0,035	30-100	+ 3,0
Mineral fibre	0,035-0,050	1	+ 0,0-2,5
Baking Cork	0,045-0,055	10-20	+ 4,5-6,0



For bonding, we recommend Super Spray Adhesive 50013. You need approx. 1 can/panel (2m²) - for flat bonding. The working temperature should not be below 15°C. Colours, dimensions and density of the panels may vary slightly due to production. We recommend a trial bonding (without guarantee).

*Shipping only possible by forwarding agency, for panel thickness 10 - 30 mm freight/packing
Stacking height 10-32 cm pallet 55,99/
Stacking height 33-200 cm 108,99/

Shipping from the Reimo warehouse is by forwarding agent. For smaller quantities, please ask your specialist dealer at what cost he can procure the panels and, if necessary, send them to you

Now also available as cut to size sets:

Insulation set for VW T5, T6 Kombi kR and IR
28 parts. 2 plates 20 mm X-Trem **50086 152,90**

Extension set for VW T5, T6 panel van kR
8 parts. 1 plate 20 mm X-Trem **500861 65,89**

Mercedes-Benz Vito VS 20 Kombi long version (length 5,14 m)
13 parts. 2,5 plates 15 mm X-Trem **50087 152,90**



Left side

Right side

INTERIOR TRIM

Interior cladding panels 3 mm



Galaway II leather grain 
Plywood panel approx. 3 mm with noble decor, can be disposed of in an environmentally friendly way. Colour: Warm beige Size: 1,22 x 2,50 m.
510071 **74,95**
GP* 24,57 / 1 sqm

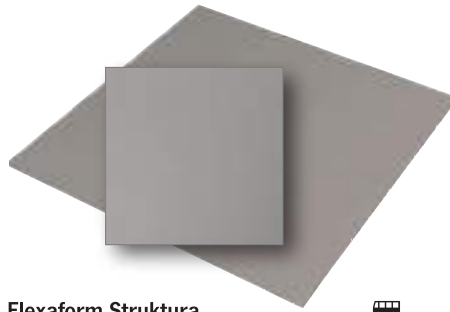

Flexaform Struktura 
Dimensionally stable special fibreboard with matt grey surface, can be disposed of in an environmentally friendly manner. More suitable for workshop vehicles than poplar plywood. Colour: Pearl grey. Size 1,22 x 2,44 m.
51010 **27,99**
GP* 9,40 / 1 sqm

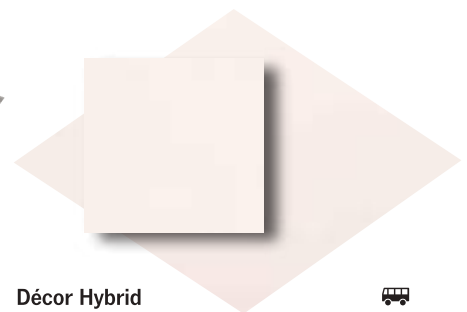

Décor Hybrid 
Dimensionally stable special fibreboard with matt grey surface, can be disposed of in an environmentally friendly manner. More suitable than poplar plywood for workshop vehicles. Colour: Eggshell
Size 1,22 x 2,44 m **51012** **56,-**
GP* 18,81 / 1 sqm

Profiles for cladding panels, 3mm

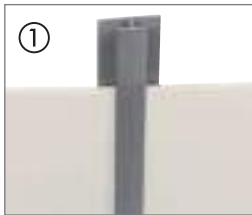

① **Joint connecting profile**
For connecting the cladding panels. 220 cm long.
Light grey **51101** GP* 3,06 / 1 m **6,74**
Dark grey **511011** GP* 2,95 / 1 m **6,49**

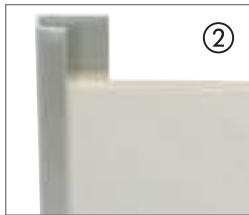

② **End profile**
Lateral termination of roof claddings, facilitates the installation, also stable termination profile for cladding panels. Suitable for panel thicknesses of 3 - 4 mm. Anodised aluminium Length: 2.54 m
51210 GP* 4,88 / 1 m **12,40**

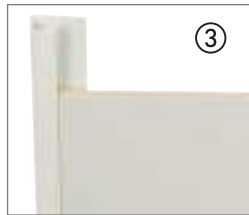

③ **End profile**
Edge protection and facing for the outer sides of the cladding panels. Facilitates installation. 220 cm long.
Light grey **51100** GP* 1,75 / 1 m **3,86**

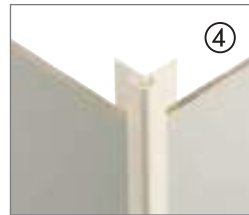

④ **Connecting profile outside, 90**
For the corner connection of the cladding panels. 220 cm long.
Dark grey **511021** GP* 2,95 / 1 m **6,49**

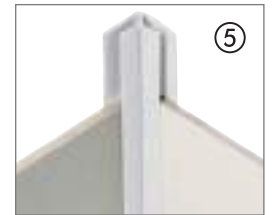

⑤ **Connecting profile inside, 90**
For 90° corner joints of cladding panels, especially necessary for interior cladding of high roofs. 220 cm long.
Light grey **51103** GP* 4,15 / 1 m **9,14**



Cap screws 3.9 x 22 mm
for fastening the cladding panels
Medium grey 20 pcs. **513004** **3,49**
Brown 20 pcs. **513000** **3,49**

The inner cladding profiles fit our side cladding panels, mounting thickness 3-4 mm.

Special adhesives for X-Trem insulator and velour fabrics



Notice:
Please test the adhesive properties of the glue before you start covering your fabrics. The substrate of the materials is often very different

⑥ **Spray adhesive**
For gluing smaller surfaces X-trem insulator to metal, wood or plastic.
500 ml can **50011** **12,-**

⑦ **Super spray adhesive**
Heat resistant up to 90°C with high instant adhesive power. Adheres to wood, metal and plastics. 500 ml **50013** **21,99**

⑧ **Macroplast adhesive B2168**
Universally applicable for bonding various materials such as wood, plastics, metals, felts, etc., both with and among each other. (Not suitable for bonding polystyrene foam, PE, PP, PTFE and soft PVC.) For specialist trade only **50036** **23,49**

Terokal Thinner R for improved sprayability of Macroplast- Adhesive B2168. 1 litre. Without illustration. **500361** **59,50**

⑨ **Synthetic resin dispersion adhesive 8/A 1728,**
10,5 kg for the bonding of foams and textiles on wood, plastic, metal; of fleeces, textiles, leather, artificial leather, horsehair or rubber mouldings with foam. Without organic solvents, contains synthetic resin dispersion with natural resins **50048** **188,-**

All dimensions are approximate



The purpose of the interior trim is to cover the fissured vehicle body on the inside in such a way that a homely atmosphere is created in the vehicle and at the same time the insulation material between the vehicle sheet metal and the interior trim is concealed

The cladding material must therefore be able to adapt well to the curvature of the body.

Interior trim fabric Fancy

- Anthracite with 4mm foam and tricot
- Weight 260g/m² +/- 5%
- Material 100% PES
- Water repellent
- Useful width min. 140 cm

Price per running meter **51025** GP* 12,11/ 1 sqm **16,95**

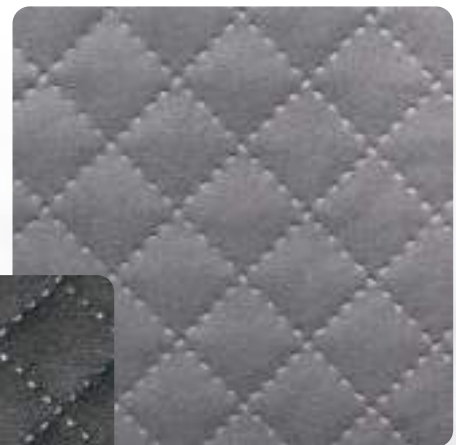
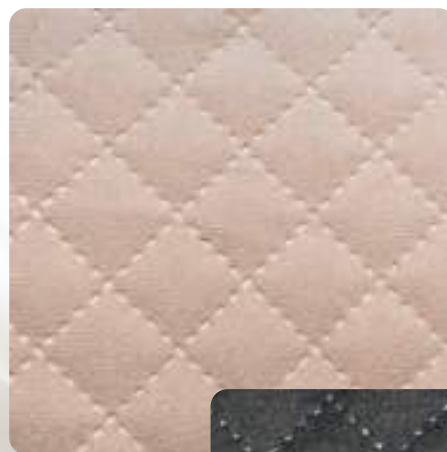
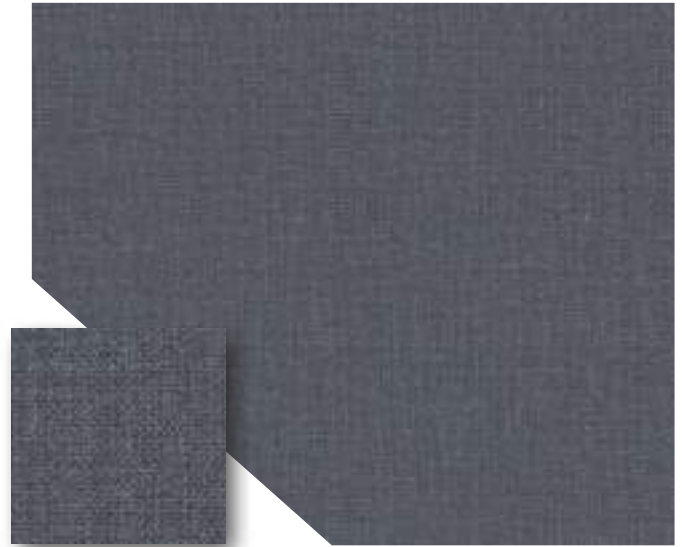

Trinity - Interior trim fabric in noble quilted look

- Velvety fabric, beautiful feel
- With embossed qu
- Reduced moisture absorption -Flame retardant treatment

Material: 100% polyester, weight: 355 g/m (+/- 5%), useful width approx. 142 cm,

Price per running meter

Colour Beige	51037	GP* 11,90/ 1 sqm	16,90
Colour grey	51038	GP* 11,90/ 1 sqm	16,90
Colour Black	51039	GP* 11,90/ 1 sqm	16,90

INTERIOR TRIM



also fleece coated available



Isovelour fabrics

Crumpled velour, backside coated with foam. Beige or grey

Ideal as wall/roof covering or for covering cladding panels (not recommended for kitchen areas due to textile-like surface). 100% polyamide. 140 cm wide, price per running metre:

Grey: 2 mm	51014	GP* 41,07/sqm	57,50
Grey: 5 mm	51015	GP* 23,56/sqm	32,99
Beige: 3 mm	510096	GP* 18,14/sqm	25,39

Crumpled velour, like 51015, but 160 cm wide

Grey: 5 mm	51017	GP* 21,81/sqm	34,90
------------	--------------	---------------	--------------

Isovelours, backside additionally fleece-coated,

i.e. the adhesive does not penetrate as quickly on the front side. 100% polyamide. 160 cm wide, price per running metre.

Grey: 3 mm	51016	GP* 20,62/sqm	32,99
------------	--------------	---------------	--------------

① Intervelours Graphite

3 mm thick flexible needlefelt for covering vehicle parts. Crease-resistant, insensitive. 200 cm wide.

Decor Graphite, Roll 50m	51020	GP* 10,89/sqm	1089,-
--------------------------	--------------	---------------	---------------



Faux leather

Bring comfort and noble appearance into your vehicle with imitation leather interior or lining

Imitation leather light grey, grained

Soft imitation leather for gluing or covering vehicleparts. Approx. 140 cm wide. Material: 53% polyurethane, 32% polyester, 15% cotton. Unlaminated, running metre

510211-1	30,50
GP* 21,42/sqm	

Laminated with 3 mm foam / Chameuse

510211	41,90
GP* 29,93/sqm	

FITTING:

Plastic wedge set, 5 pcs.

Ideal for removing trim parts, mouldings, etc. without damaging the paintwork. Practical combination of different wedge

and lever variants. Robust special plastic

50093	22,90
--------------	--------------

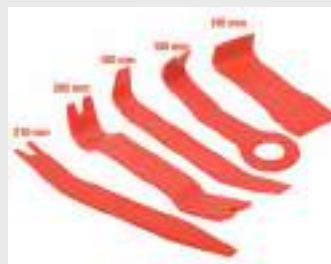

All dimensions are approximate

X-Trem® Stretch Carpet Felt Easy-Trim, easy to install

- The most popular type of vehicle trim in England
- Easy processing, therefore perfect for do-it-yourselfers
- 4-way / superstretch (4-Way Superstretch)
- In 5 different colours
- Suitable for all surfaces (wood, plastic, metal and also on insulation)
- The vehicle interior insulate (acoustics) and beautify
- Due to the special stretching ability, even curves such as wheel arches are no problem

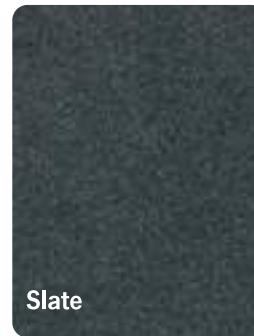
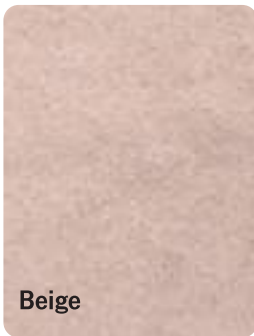

X-Trem® Stretch Carpet Felt

- Highly flexible needle felt velour
- Thickness approx. 4.6 mm,
- Weight approx. 390 gr/sqm.
- Material: 100% Polyester

Color	Roll W 2 x L 2 m (4m ²)			Cut to size W 2 x L 5 m (10m ²)			Roll W 2 x L 30 m (60m ²)		
Beige	500891	75,60	GP* 18,90/sqm	500890	139,-	GP* 13,90/sqm	50089	559,-	GP* 9,32/sqm
Silver grey	500831	75,60	GP* 18,90/sqm	500830	139,-	GP* 13,90/sqm	50083	559,-	GP* 9,32/sqm
Dark grey	500841	75,60	GP* 18,90/sqm	500840	139,-	GP* 13,90/sqm	50084	559,-	GP* 9,32/sqm
Slate	500851	75,60	GP* 18,90/sqm	500850	139,-	GP* 13,90/sqm	50085	559,-	GP* 9,32/sqm
Anthracite	500881	75,60	GP* 18,90/sqm	500880	139,-	GP* 13,90/sqm	50088	559,-	GP* 9,32/sqm

Self-adhesive Super Stretch Carpet Felt

Black, thickness 3 mm, weight approx. 365 gr/sqm. 100% Polypropylene

Roll W 1,4 x L 60 m **50092 659,-**
GP* 7,85/1 sqm

Cut to size B1,4 x L 5 m **500920 95,90**
GP* 13,70/1 sqm



Camper carpeting - needle felt in ribbed look

- Easy-Trim carpet, easy to cut with scissors

Black, thickness 3,8 mm, weight approx. 500 gr/sqm. 100% polypropylene.

Roll W 2 x L 30 m **50091 364,-**
GP* 6,07/1 qm

Cut to size W 2 x L 5 m **500910 79,90**
GP* 7,99/1 qm



All dimensions are approximate.

FURNITURE PANELS

Poplar plywood with CPL or HPL laminate surface

- Extremely light - from 7.2 kg/m²
- Very stable with 0.6 mm coating
- Pressure and scratch resistant
- Easy-care surface, long durability
- Panel thickness approx 15 mm

- Panel size approx. 122 x 244 (approx. 2.98 m²)
- Strong special coating in HPL quality
- Particularly high surface quality

also available as 1/4



"High gloss white" HPL laminate 🚚

Weight of whole board: approx. 25 kg
 Whole board (122 x 244 cm) **52025 214,90**
GP 72,19/1 sqm
 1/4 board (61,1 x 122 cm) **520260 64,90**
GP 87,11/1 sqm

Corner connection profile 90° as connection to the wooden panel. Both sides open. Aluminium, length 220 cm
522141 44,99
GP 20,45/1 m

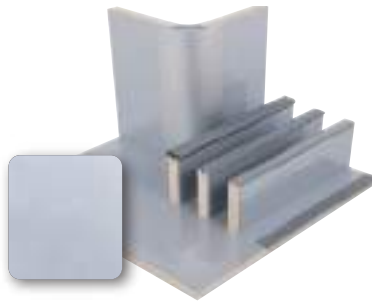

"High gloss silver" HPL laminate 🚚

Weight of whole board: approx. 25 kg
 Whole board (122 x 244 cm) **520252 239,-**
GP 80,28/1 sqm
 1/4 board (61,1 x 122 cm) **520261 64,90**
GP 87,11/1 sqm

Corner connection profile 90° as connection to the wooden panel. Both sides open. Aluminium, length 220 cm
522141 44,99
GP 20,45/1 m

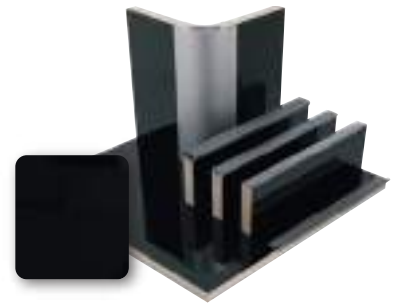

"High gloss black" HPL laminate 🚚

Weight of whole board: approx. 24,5 kg
 Whole top (122 x 244 cm) **520251 228,-**
GP 76,59/1 sqm
 1/4 board (61,1 x 122 cm) **520262 64,90**
GP 87,11/1 sqm

Corner connection profile 90° as connection to the wooden panel. Both sides open. Aluminium, length 220 cm
522141 44,99
GP 20,45/1 m



"High gloss olive" HPL laminate 🚚

Weight of whole board: approx. 24,0 kg
 Whole top (122 x 244 cm) **52019 207,-**
GP 69,53/1 sqm
 1/4 board (61,1 x 122 cm) **520191 54,90**
GP 73,68/1 sqm

Corner connection profile 90° as connection to the wooden panel. Both sides open. Aluminium, length 220 cm
522141 44,99
GP 20,45/1 m



"Cherry" HPL laminate 🚚

Weight of whole board: approx. 23,5 kg
 Whole board (122 x 244 cm) **52016 193,90**
GP 65,13/1 sqm
 1/4 board (61,1 x 122 cm) **520161 53,90**
GP 72,35/1 sqm

Corner connection profile 90° as connection to the wooden panel. Both sides open. Aluminium, length 220 cm
522003 23,99
GP 10,90/1 m



"Apple" HPL laminate 🚚

Weight per board: approx. 23,0 kg
 Whole board (122 x 244 cm) **52012 195,99**
GP 65,83/1 sqm
 1/4 board (61,1 x 122 cm) **520121 54,90**
GP 73,68/1 sqm

Corner connection profile 90° as connection to the wooden panel. Both sides open. Aluminium, length 220 cm
522141 44,99
GP 20,45/1 m



"Walnut" HPL laminate 🚚

Weight per board: approx. 21,5 kg
 Whole board (122 x 244 cm) **52023 217,-**
GP 72,89/1 sqm
 1/4 board (61,1 x 122 cm) **520231 57,99**
GP 77,84/1 sqm

Corner connection profile 90° as connection to the wooden panel. Both sides open. Aluminium, length 220 cm
522141 44,99
GP 20,45/1 m

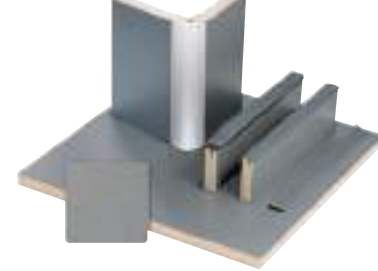

"Anthracite Metallic" HPL laminate 🚚 Weight

per panel: approx. 24,0 kg
 Whole board (122 x 244 cm) **520151 212,90**
GP 71,51/1 sqm
 1/4 board (61,1 x 122 cm) **520152 57,30**
GP 76,91/1 sqm

Corner connection profile 90° as connection to the wooden panel. Both sides open. Aluminium, length 220 cm
522141 44,99
GP 20,45/1 m



"Granito" CPL laminate 🚚

Weight per panel: approx. 23,5 kg
 Whole board (122 x 244 cm) **52007 195,99**
GP 65,83/1 sqm
 1/4 board (61,1 x 122 cm) **520071 53,90**
GP 72,35/1 sqm

Corner connection profile 90° as connection to the wooden panel. Both sides open. Aluminium, length 220 cm
522141 44,99
GP 20,45/1 m

Shipping of wooden boards: 1/4 boards (61x122 cm) can be shipped without bulky charges. The shipping costs remain reasonable. Whole boards (122x244 cm) will be shipped by a forwarding agency from a minimum order quantity of 2 pieces (also mixed). This results in higher shipping costs. It is simpler and cheaper to collect whole boards from your dealer.

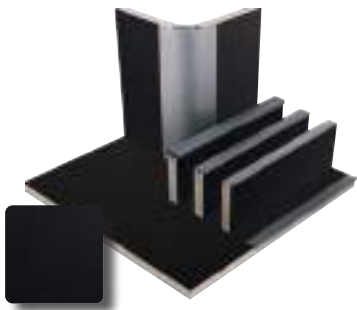

"Matt Black" HPL laminate

Weight per board: approx. 26,5 kg
Whole board (122 x 244 cm) **52096 249,-**
GP 83,64/1 sqm

Corner joint profile 90°. Both sides open. Aluminium, length 220 cm **522141 44,99**
GP 40,11/1 m



"Pearl" HPL laminate

Coated on both sides. Weight per board: approx. 25kg Board thickness approx. 15 mm
Whole board (122 x 244 cm) **52073 299,-**
GP 100,44/1 sqm

Corner joint profile 90°. Both sides open. Aluminium, length 220 cm **522141 44,99**
GP 20,45/1 m

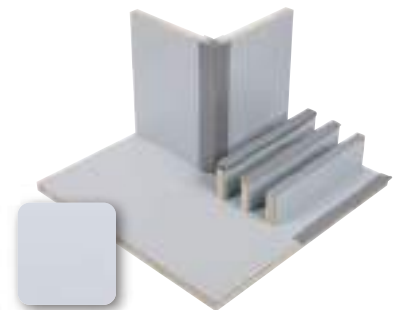

"Pure Graffiti" matt HPL laminate

Weight of whole board: approx. 26,5 kg
Whole board (122 x 244 cm) **52091 119,40**
GP 40,11/1 sqm

Corner connection profile 90° as connection to the wooden panel. PVC, length 220 cm **522004 31,13**
GP 13,55/1 m



"Olmo" HPL laminate

Weight per board: approx. 23.0 kg Board thickness approx. 15 mm
Whole board (122 x 244 cm) **52048 226,-**
GP 75,92/1 sqm

Corner joint profile 90°. Both sides open. Aluminium, length 220 cm **522141 44,99**
GP 20,45/1 m

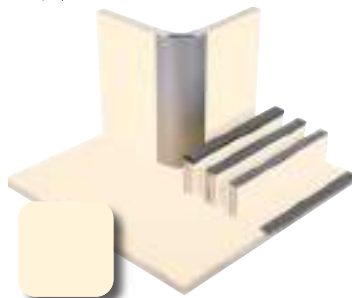

"Matt Cream" HPL laminate

Whole board (122 x 244 cm) **52095 124,90**
GP 41,95/1 sqm
1/4 board (61.1 x 122 cm) **520951 34,99**
GP 46,97/1 sqm

Corner connection profile 90° as connection to the wooden panel. Both sides open. Aluminium, length 220 cm **522004 31,13**
GP 13,55/1 m



"Maple" matt HPL laminate

Weight per board: approx. 26 kg
Whole board (122 x 244 cm) **52092 124,99**
GP 41,99/1 sqm
1/4 board (61,1 x 122 cm) **520921 35,99**
GP 48,31/1 sqm

Corner connection profile 90° as connection to the wooden panel. Both sides open. Aluminium, length 220 cm **522004 31,13**
GP 13,55/1 m



EXCLUSIVE

"Mother of pearl" glossy HPL laminate

Weight per board: approx. 26 kg
Whole board (122 x 244 cm) **52090 139,40**
GP 46,83/1 sqm

Corner connection profile 90° as connection to the wooden panel. Both sides open. Aluminium, length 220 cm **522141 44,99**
GP 20,45/1 m

Plywood panels cheap

- Extremely lightweight but still very stable due to layered structure
- Easy to clean surface
- Weight approx. 7 kg/m²

① poplar plywood light grey

Weight per board: approx. 23.5 kg. Board thickness: ca. 15 mm
Whole board (122 x 244 cm) **52010 152,-**
GP 51,06/1 sqm

ATTENTION: Different panel size

② Plywood natural

Untreated, environmentally friendly in production and disposal, breathable, easy to work with. Weight per board: approx. 30 kg, Pl.thickness: approx. 18 mm

Whole board (122 x 244 cm) **52030 91,-**
GP 23,98/1 qm

③ Natural poplar plywood

Weight per board: approx. 17,0 kg. Board thickness: approx. 14/15 mm

Whole board (122 x 244 cm) **52000 85,50**
GP 22,84/1 sqm

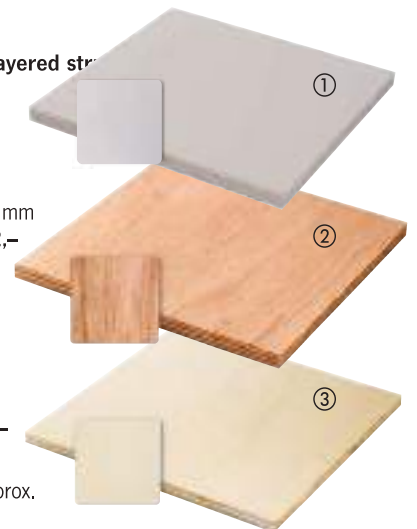

HPL laminate: HPL stands for High Pressure Laminate - i.e. a laminate created by high-pressure pressing of several layers of paper with hardening synthetic resin, or high-pressure laminate for short. The surface is covered with a protective film of melamine resin. The high pressing pressure creates a closed, pore-free surface. HPL surfaces are extremely hard-wearing, scratch and impact resistant, insensitive to dirt, lightfast and resistant to common household chemicals. Boiling water, damp or dry heat leave no traces. We use HPL laminate panels in our motorhome extensions

LIPPING + CONNECTING PROFILES

- The tried and tested furniture system for the self-builder
- With rounded, padded edges
- Protects the wooden edge, high stability
- Material: PVC
- Is hammered into the milled groove

Padded edging 15 mm Air-cushioned edge protection profile with one-sided nose

Silver

5 m	GP 5,38/1 m	5210779	26,91
25 m	GP 4,76/1 m	5210778	119,-

Dark grey

5 m	GP 5,61/1 m	5210719	28,04
25 m	GP 4,97/1 m	5210718	124,15

Medium grey

5 m	GP 4,97/1 m	5210749	24,85
25 m	GP 4,21/1 m	5210748	105,24



Upholstered door edging 15 mm

for semi-set-up doors such as the Classic furniture system. This means that there is no waste of wood when building doors and flaps

Dark grey

5 m	GP 6,68/1 m	5210519	33,39
25 m	GP 5,86/1 m	5210518	146,49

Medium grey

5 m	GP 6,68/1 m	5210549	33,39
25 m	GP 5,88/1 m	5210548	146,91



Door inner liner with sealing lip

door cut-out

Medium grey

5 m	GP 3,74/1 m	5210349	18,69
40 m	GP 4,17/1 m	5210348	166,60



Postal delivery is only possible up to max. 170 cm. If you explicitly order the original length of 220 cm, we deliver via UPS

T-edging with nose 15 mm with nose on one side to cover cut edges

Light grey

5 m	GP 2,58/1 m	521019	12,90
40 m	GP 2,99/1 m	521018	119,50

Medium grey

5 m	GP 3,38/1 m	5210149	16,90
40 m	GP 3,37/1 m	5210148	134,90

Dark grey

5 m	GP 4,73/1 m	5210119	23,65
40 m	GP 3,73/1 m	5210118	149,20

Silver

5 m	GP 3,38/1 m	5210179	16,90
40 m	GP 3,37/1 m	5210178	134,90

Décor Apple

5 m	GP 4,40/1 m	5210129	21,99
40 m	GP 4,48/1 m	5210128	179,-



T-border standard 15 mm

Dark grey

5 m	GP 3,99/1 m	5210019	19,94
40 m	GP 4,50/1 m	520018	180,-

Medium grey

5 m	GP 5,90/1 m	5210049	29,50
40 m	GP 6,48/1 m	5210048	259,22



T-glue half-round 15 mm to cover the cut edges

Décor cherry

5 m	GP 4,60/1 m	527072	23,-
50 m	GP 4,60/1 m	527071	230,-



Stop edge

Stop edge for shelf or cupboard bases. For 15 mm board thickness.

Medium grey, 220 cm rod

521104	17,99
GP 8,18/1 m	



Mounting accessories

Universal slitting cutter 30 x 1,5 mm
52701 6,20



Special glue

For gluing glue-ons into the wood groove. Contents 85 g

GP* 10,38/100 g	52713	8,83
-----------------	--------------	-------------

White glue tube Bindau-RS

20 g GP* 14,95/100 g **52714 2,99**



Dowelfix

Marking aid for easy installation of wooden dowels
Ø 6 mm, 4 pcs. **53245 3,11**



Connection profiles



Upholstered corner profile

Padded special profile for 90° connection of furniture boards. Matches the colour of the edgings and furniture handles. Length 220 cm

Dark grey	GP 14,01/1 m	522001	30,82
Medium grey	GP 14,15/1 m	522004	31,13



Corner profile

90° aluminium profile connection for 15 mm. Wooden boards. Length 220 cm.

2-sided open	GP 20,45/1 m	522141	44,99
1-sided open	GP 18,18/1 m	52216	40,-

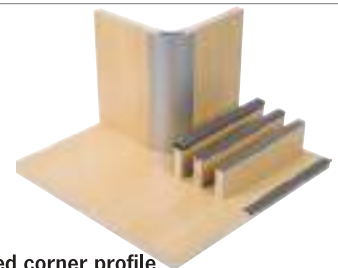

Installation tip for the floor structure

The floor panel should compensate for unevenness of the vehicle floor, insulate against cold and sound and enable furniture to be fixed. Since moisture cannot always be ruled out in the floor area, the material must be moisture-resistant and low in distortion. As a compromise between weight and strength, waterproof chipboard 10 mm thick has proved to be the best solution.

Screw connections that require greater strength are made through the carriage floor for safety reasons. Attention: Seal all drill holes well to the outside. Plastic floor coverings are best suited as coverings. They are easy to clean and do not allow moisture to penetrate the wood. The covering should be glued to the floor panel over its entire surface so that it does not blister. Permanently installed carpets are not recommended because cleaning is problematic. You should pay particular attention to door entrances and finishing edges of fixtures. Sealing with suitable sealant prevents water penetration.

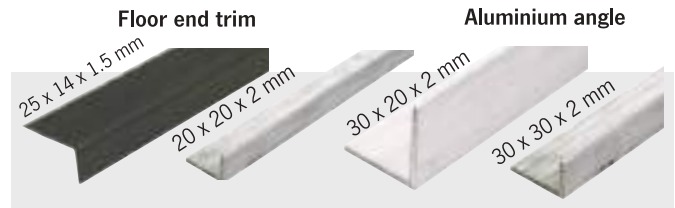
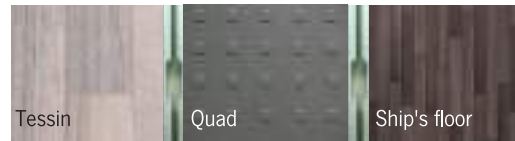
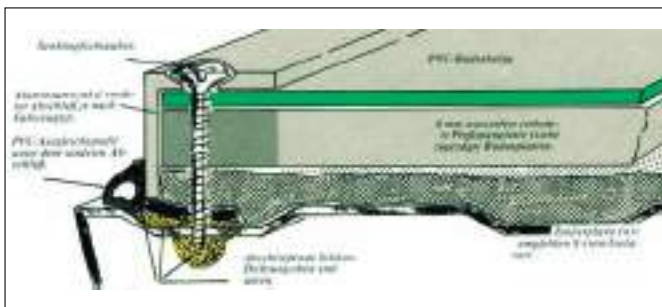

Floor panels: Approx. 10 mm thick, made of waterproof glued chipboard coated with plastic floor covering. Supplied without insulation and aluminium angles. X-Trem insulation is ideal for floor insulation. For the entrance of Transporter Gen. 4 we recommend the entrance steps. Some floor panels can only be manufactured in 2 parts due to their size

Quad	290 x 163 x 1,00 cm	10519	369,-
Quad	250 x 163 x 1,00 cm	10524	350,87
Ticino	340 x 180 x 0,95 cm	10539	399,-
Tessin	300 x 170 x 0,95 cm	10538	299,-
Tessin	250 x 170 x 0,95 cm	10537	279,-
Ship's floor	340 x 180 x 0,90 cm	105393	399,-
Ship's floor	300 x 170 x 0,80 cm	105383	299,-
Ship's floor	250 x 170 x 0,90 cm	105373	279,-

Shipping of floor boards is unfortunately not possible.

Tips and tricks for vehicle insulation

Preliminary work:

Your vehicle (panel van or station wagon) is prepared to the extent that you can start with the first steps towards insulation. Existing interior panelling has been removed and cut-outs have been made for later installations, e.g. windows, CEE socket, chimneys or ventilation grilles. So that you can now begin with the insulation, the side walls of your vehicle must be dry and free of grease. You should also remove any wax residue.

Insulation:

To insulate the vehicle sidewalls, ceiling and floor, we recommend our X-Trem insulator. This has the following advantages over other insulation materials, such as polystyrene or rock wool: You can cut X-Trem insulator excellently with a sharp knife, this insulation material is flexible and can therefore be adapted well to the curvatures of the vehicle body. Further advantages: Very high insulation even with low material thicknesses (saves space and weight). Our X-Trem insulator is closed-pored (i.e. it cannot absorb water) and it is also flame retardant from 15 mm thickness.

First, cut a few pieces of X-Trem Insulator to the desired size. To do this, hold it up to the surface to be insulated, bearing in mind that if the surface is difficult to access, the insulator piece together with the adhesive will have to be attached later.

Now coat the cut X-Trem parts with Macroplast adhesive (Art. No. 50036). We recommend thinner 500361 for improved sprayability. Then apply the adhesive to the side wall or ceiling. Only a brush can be used for this. Basically, both surfaces must be covered with adhesive.

Furthermore, the adhesive must be applied over the entire surface so that there is no air space between the vehicle panel and the X-Trem insulator. This shifts the dew point into the insulation and thus prevents condensation.

Once the adhesive has been applied, the insulation is placed after a flash-off period. Here, it is not the duration of the contact pressure that is decisive for the adhesive force, but the amount of contact pressure. Therefore, press the X-Trem insulator on correctly at all points. Proceed in the same way for walls and ceilings.

For the floor, you can also use X-Trem insulation material. In this case, however, the X-Trem Insulator is not glued, but simply placed under the floor slab.

If you follow this advice, you will have a cooler vehicle in the summer and a warmer one in the winter. For once, when it comes to insulation, the principle is: a lot helps a lot!

More info: www.reimo.com

Interior cladding

The thick and strongly structured films of Graffiti cladding are much more robust than thin, smooth PVC films.

In case of strong bending or in the area of screw connections, the foil can peel off. Poplar plywood with a strong structural film such as the Reimo Isovelours or the special fibreboard Flexaform Struktura are therefore more suitable

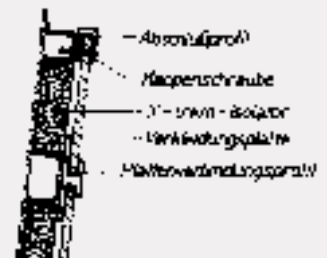

Flat roof cladding

Screw aluminium clamping profiles to the right and left of the longitudinal beams

The screw heads must be well countersunk! Cover the roof surface with X-Trem insulator. You then place the cladding panel in the clamping profile on one side, curve it downwards in the middle and place the edge on the clamping profile on the other side. Finally, gently push the panel up the middle until it fully snaps into the profile. 2 panels are connected with a H-profile.

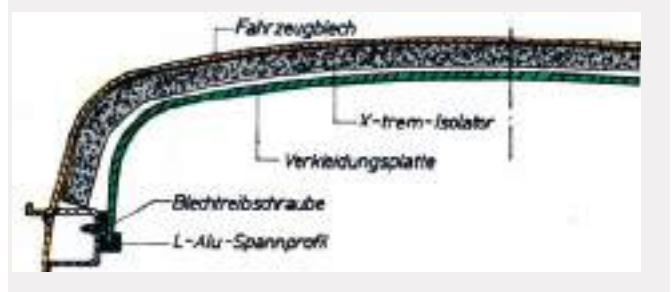

COMPONENTS FOR FURNITURE CONSTRUCTION

Connector for furniture construction

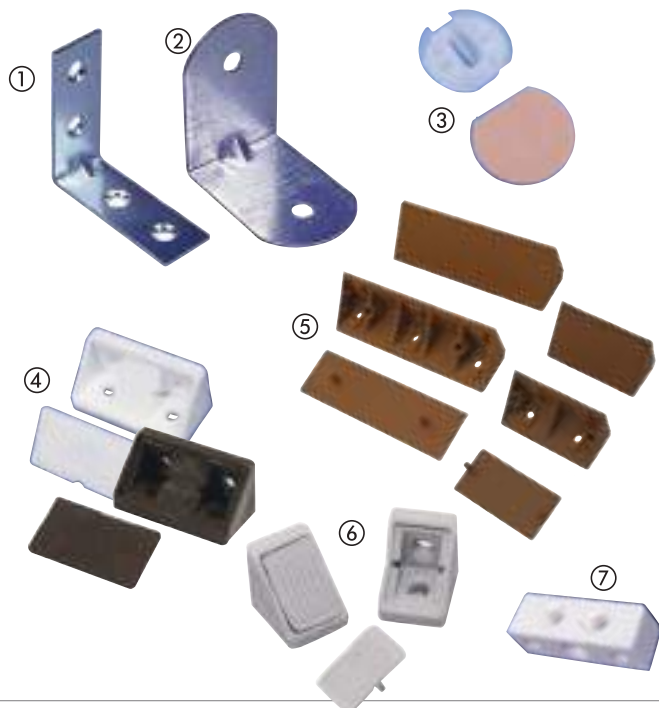

① **Chair bracket** metal material thickness 15mm, 4 pieces 25 x 25 **532264 8,98**

② **Heavy chair bracket** for fastening to vehicle bodywork. Robust, galvanised. For screws up to Ø 6 mm. Dimensions: 50 x 50 x 34 mm 4 pieces **532204 6,99**

③ **Cup connectors**, ideal for cabinet construction. Concealed, flush 90° connections. Incl. cover caps. Ø25 x H8mm.
Light brown:
10 pcs. **532870 3,99**
50 pcs. **53287 13,99**
Medium grey:
10 pc. **532875 4,17**
100 pcs. **532874 24,48**

④ **Plastic corner connector** easier and more accurate to

install than a sheet metal angle, with cover cap. 10 pieces

Grey **53230 4,25**
Brown **532300 4,37**
Light brown **532301 4,37**
White **532303 4,37**

⑤ **Corner connector set** Universal corner connector with cover plate for building benches, cupboards, storage boxes etc. For screws up to Ø 4 mm:
W60 x D21 x H21 mm
6 pcs. **53233 10,70**
W100 x D21 x H21 mm
6 pcs. **53234 12,50**

⑥ **Furniture corner connector** 2-hole, plastic. Light grey With cover plate. 10 pcs. **53235 3,62**

⑦ **Square furniture connector**
Brown **532310 3,82**
White **532313 3,59**

Angle fitting



Table top holder aluminium, natural anodized **53358 15,10**
black anodized **53359 15,99**

Flap display



① **Gas damper** 100N, for heavy dampers. With 2 screw-on brackets **53218 14,99**
Length: 275 mm

② **Support damper holder metal** Keeps large flaps closed with spring force, no guard locking required
Can be used on the right as on the left
140 mm **53211 5,31**
200 mm **53212 6,25**
250 mm **53213 7,10**

③ **Support flap holder plastic** for light flaps up to approx. 500 mm wide .4 pcs:
Light grey **532101 5,55**
Light brown **532102 5,55**

Screws for wood and metal



① **Stainless steel lens head screws** rustproof For mounting roof hoods, CEE sockets, ventilation grilles. 3,9 x 25 mm
20 pcs. **533083 4,-**

② **Countersunk head screws** For fastening Highrail and Multira-il. Black,
20 pcs **53306 4,90**

③ **Spax cap screws** incl. cover caps. Head drilled for wood, cross recess with countersunk head, light grey. 4,5 x 40 mm,
20 pcs **53290 4,-**

④ **Teks screws** self-drilling tip, no pre-drilling in sheet metal 3,9 x 16 mm,
20 pcs **29429 3,-**



Consoles for foldable work surfaces

- ① **Metal folding bracket**
with latching spring, length: 250 mm
galvanised **53310 20,19**
- ② **Metal folding bracket**
folding hinge in the middle,
assorted colours, l.: 330 mm
53322 34,97
- ③ **Plastic bracket**
swivels to the side, length: 190mm
Brown **53300 5,27**
Grey **53302 5,27**
- ④ **Aluminium folding bracket
with one-hand operation,**
Length: 150, load capacity >60 kg
silver-coloured **533132 33,55**
Length: 252, max. load >55 kg
silver-coloured **53312 36,43**
black **533601 36,20**
Length: 402, load capacity >60 kg
silver **53313 56,66**
black **533602 55,91**
Length: 549, Load capacity >65 kg
silver **533131 66,35**
black **533603 64,95**



Möbel- und Türgriffe

- ① **Metal handle, 173 x 22 mm,**
hole spacing 160 mm
53440 3,70
- ② **Metal handle, zamak**
53441 21,50
- ③ **Furniture handle incl. catch**
Plastic, 185 x 15 mm, hole spacing
160 mm **53367 8,40**
- Elegant door / flap handle**
Made of zamak with chrome finish. Width 180 mm
- ④ **Outside handle 534091 11,50**
- ⑤ **Lock 53418 1,20**



Bow handles

- ① **Silver matt**
Mounting dimension: 160 mm
293205 15,20
- ② **Silver matt, stainless steel**
Mounting dimension: 96 mm
53122 6,90
- ③ **Nylon medium grey**
Mounting dimension: 96 mm
53118 10,06
- ④ **Nylon light grey**
Mounting dimension: 64 mm
53112 6,08



Cabinet handles with push buttons

- ① **Centre push-button, chrome gloss**
Hole spacing: 128 mm, height: 18 mm
Installation set with locking unit
53109 17,30
- ② **Pushbutton, centre, silver matt**
Hole spacing: 128 mm, height: 18 mm
Installation set with locking unit
53110 16,80
- ③ **Pushbutton, centre, material ABS,**
Hole spacing: 224 mm, height: 28.3
mm, incl. lock **53432 19,19**
- ④ **Pushbutton, centre, chrome gloss**
Hole spacing: 160 mm, width: 195
mm, height: 30 mm
52426 16,99

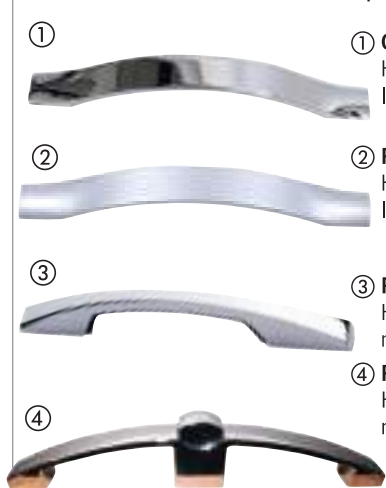

Metal handles

- ⑤ **Cabinet handle with lock 210 x**
25 mm, hole spacing 128 mm
53413 10,-
- ⑥ **Cabinet handle without pushbut-**
ton 200 x 25 mm, hole spacing 160
mm **53414 8,70**
- Handles plastic**
- ⑦ **Cabinet handle, 188 x 20 mm**
hole spacing 128 mm
53411 6,30
- Handle "Combi Line"**
Elegant furniture handle with push-but-
ton mechanism (one-hand operation)
- ⑧ **Silver/Sw. 52454 6,38**

FURNITURE HINGES

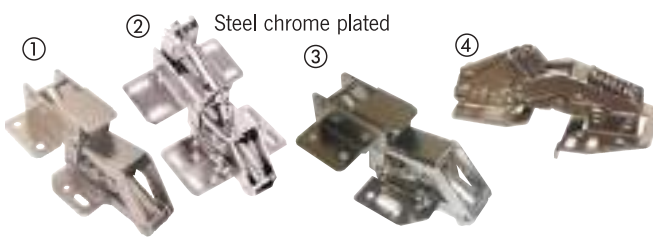

Steel chrome plated

Overhead cabinet & corner hinges

① Reinforced version for large flaps	531951	5,99
② Special version	531961	4,70
③ 2 springs, small to medium flaps	531971	5,20
④ With softclosing system and adjustable opening angle	53341	9,98



Special hinge for semi-mounted doors

Robust; powder-coated; colour-matched to the lipping
Can be used on the right and left by repositioning.

Left, 2 pieces			Right, 2 pieces		
Light grey	523012	5,31	Light grey	523002	5,31
Brown	5230102	5,31	Brown	5230002	5,31
Dark grey	5230112	5,31	Dark grey	5230012	5,31
Medium grey	5230142	5,31	Medium grey	5230042	5,31

Furniture hinges

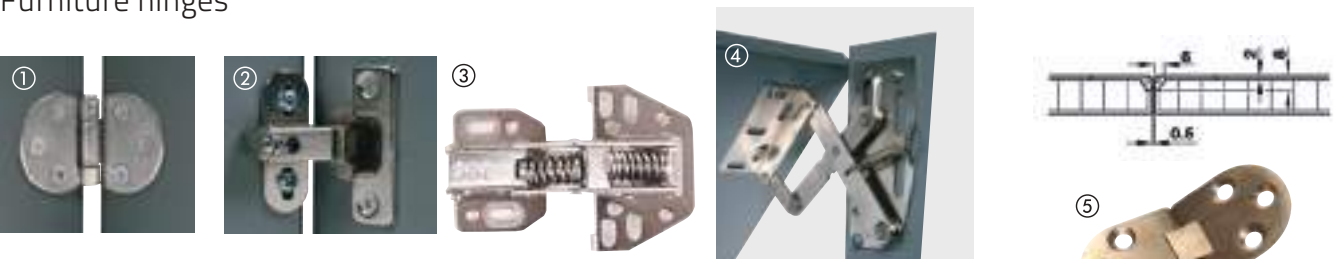

① For folding table tops. Brass version 30 mm wide. 2 pcs. 53264 7,98	③ Spring hinge Sturdy metal design, opening angle: 92°, built-in spring. Can be screwed on with stop and slotted holes for easy assembly. 2 pieces 53229 7,98	④ Flap fitting Stable, height and side adjustable, to screw on. High spring force, slotted holes. Mounted to top edge of flap with 2 mm clearance to ceiling/wall. Ideal for overhead cupboards and chests. 2 pcs. 53228 11,-	⑩ For folding tables Brass matt 65 x 30 mm, 1 piece 532192 11,40 65 x 30 mm, 2 pieces 532193 23,90
② With small head housing Ø 26 mm. Opening angle: 90° Also suitable for thin doors Cup depth 12 mm. Adjustable. 2 pcs. 53261 8,60			

Furniture / Universal Hinges

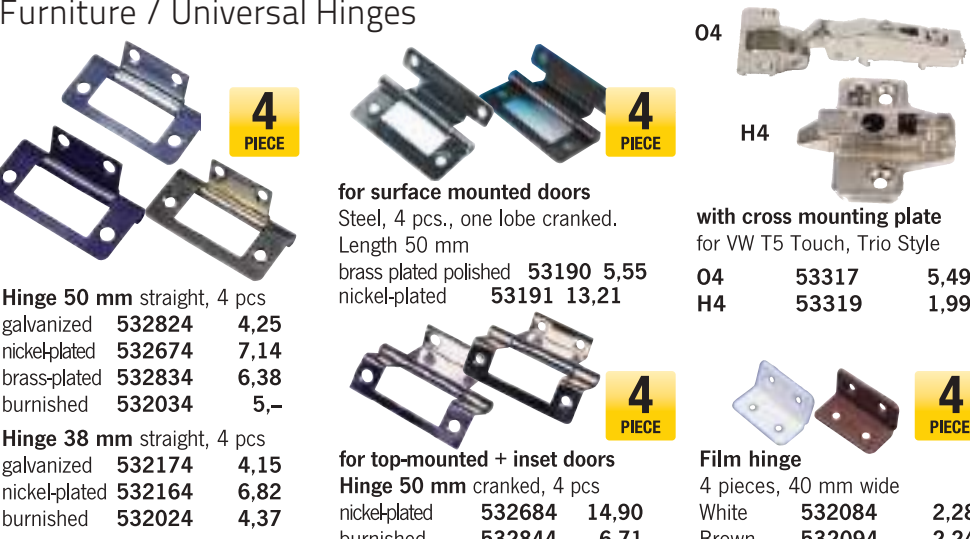

Hinge 50 mm straight , 4 pcs galvanized 532824 4,25 nickel-plated 532674 7,14 brass-plated 532834 6,38 burnished 532034 5,-	Hinge 38 mm straight , 4 pcs galvanized 532174 4,15 nickel-plated 532164 6,82 burnished 532024 4,37	for surface mounted doors Steel, 4 pcs., one lobe cranked. Length 50 mm brass plated polished 53190 5,55 nickel-plated 53191 13,21	for top-mounted + inset doors Hinge 50 mm cranked , 4 pcs nickel-plated 532684 14,90 burnished 532844 6,71
		with cross mounting plate for VW T5 Touch, Trio Style O4 53317 5,49 H4 53319 1,99	Film hinge 4 pieces, 40 mm wide White 532084 2,28 Brown 532094 2,24

Accessories hinges



Bracket for furniture hinge 53317
With aluminium profile 52216
533170 9,90

Piano hinge
for 16 mm panels. 175 cm long
Stainless steel
532051 16,99



Tension strap
with grip strap **52544 10,14**



Clamping strap lock
with toggle handle
Closure **52543 11,96**
Pin **52545 3,42**



Closure safety fields
Prevents unintentional opening of a flap **52542 4,80**



Rotary lock
high closing force, concealed tension spring compensates for assembly tolerances.
52541 20,99



2
PIECE

Mini Latch
Opens and closes by simply pressing the
2 pieces **532521 5,75**



2
PIECE

Double ball catch
For drawers and flaps. Nickel-plated with chrome steel balls 43 mm.
2 pieces **532551 8,40**



2
PIECE

Plastic catch Tumbler for drawers.
2 pieces **532501 2,88**



2
PIECE

Double roller catch Metal version, galvanised
2 pieces **532502 4,37**



50 x 70 mm

Plastic catch
With self-adjusting latch. Closure with closing angle. Housing, latch, guide and closing angle: white nylon. Spring: stainless steel SAE series 300, passivated **52540 9,40**



Snap closure
Simple. Made of plastic **52539 13,19**



Lock Stop
Simple. Secures doors up to 17 mm thick. Can be screwed on. Also as refrigerator lock.
Brown **532650 3,72**



Tongue Lock
① Galvanized steel, for 8 mm socket wrench. Dimensions: 100 x 19 x 10 mm **53246 6,91**
② Socket wrench for tongue lock 7-10 mm **53247 6,71**



Damper stay
with adjustable spring force, galvanized steel and black plastic **53243 5,49**



Metal twist lock
Fuse for large flaps. Chrome-plated die-cast zinc.
Overlap 3 mm. Base plate: H 5 mm **53253 11,90**
Overlap 6 mm. Base plate: H 8 mm **53291 11,90**



Plastic twist lock
Pre-driver fuse for large Klap-pen. Plastic, 3.5 mm base plate
Brown **53254 4,80**
White **532542 4,58**



Door damper
including screw-on bearing. Ellipse shape, plastic, Colour: grey **532480 4,69**



Locking device
for doors and flaps. Protects against door slamming in windy conditions, keeps luggage flaps open.
Grey **52450 3,25**
White **524503 3,42**
Black **524507 3,42**
Beige **524501 3,25**



Cara-Snap
Locking system for storage compartments. Includes handle catch, counter bearing and stop. Screw-on latch catch with pull release. Screw-on assembly. Backset 16 mm. **53379 12,-**



Spacer plates
For adjacent door stops. For raised mounting. Height 10 mm.
Grey **524502 1,70**
White **524504 1,70**
Black **524505 1,54**

FURNITURE HANDLES AND LOCKS

Furniture handles



Furniture handle 2000, for wooden boards from 15-18 mm

• 10.000 tested locks, tested by TÜV Mannheim

① Light grey	52415	6,79
② Medium grey	524154	6,79
③ Dark grey	524151	6,79
④ Brown	524150	6,49
⑤ Reimo furniture handle 2000, round, yellow	524009	2,99

Furniture handle for wooden boards from 15-18 mm, angular shape, 5x5 cm

- Flat fitting, ergonomically styled
- Robust sliders with good grip

⑥ Dark grey	524101	6,49
⑦ Brown	524100	6,49

Furniture lock for 15 mm wood panel thickness

⑧ Brown	524200	6,-
---------	--------	-----

Locks for wet rooms

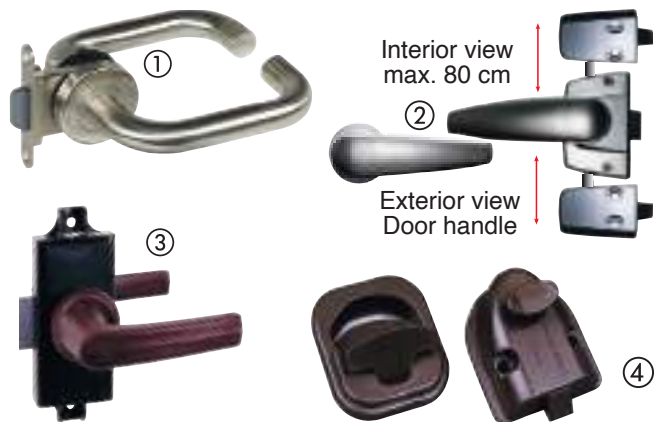

① Door handle set

Mortise latch lock with square follower Complete with door handle and Lock case made of zinc die-cast, nickel-plated.

53265 65,35

② Toilet room lock with three-point locking system

2 espagnolette bars a 80cm, can be shortened

Silver matt 52473 46,33

Chrome glossy 524731 53,24

③ Toilet room lock, 3-piece with rosettes and door handle

Brown 52472 13,83

④ Toilet room lock

oval shape, recessed version with inside opening

Brown 524250 9,95

Push button furniture lock



42x 42 mm, lock separate

① Frame matt, Knob dark grey matt 532703 7,60

② Lock as counterpart to 532703 5327031 4,95

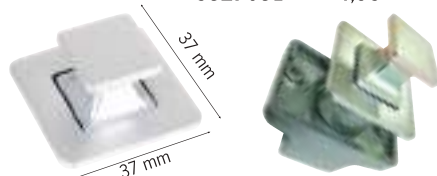

37x 37 mm, lock included

Frame matt, knob chrome matt
Incl. lock 532702 8,90

Freely combinable
with many buttons



Push Lock Locks loose

- For panel thickness 12-19 mm Lock and knob freely combinable
- For individual fitting

Basis are the locks, which can be equipped with different knobs and rosettes. Please always order knob & rosette or knob set to match. Also order strike plate separately.

① MaxiCastle 53416 5,99
② Lock Mini 53415 4,49

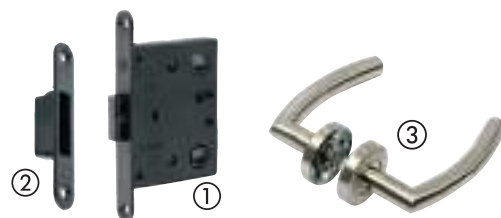

Mortiselatch lock Magnet-Lock

Mortise lock for room doors with magnetic locking. When the door is closed, the lock latch is magnetically pulled into the counter plate. Can be used on the left and right.

① Mortise lock

Installation size: 80,5 x 59 mm, thickness 12mm
532511 13,79

② Counter plate for 532511 532512
7,44

③ Door lever sets for mortise latch lock

Crescent shape, metal version chrome matt
53251 21,19

Rotation Push Lock



Door handle

Mounting dimension 3-22mm
Easy installation, suitable for wet room

52530 30,33



Door push button *

Single hole mounting. Opens by turning the knob. Door leaf thickness 1.2-19 mm

52534 25,14

Point Push Lock



Door push button *

Mounting dimension Ø 25 mm. Easy installation, matt/chrome. 52531 20,98
chrome/meas. 5253217,59

Coat hook*



Coat hook PushLock*

Ø 33 mm for door thickness 4 - 25.4 mm

52533 24,48

Castle



Compression lock

Single hole mounting. With lock cylinder, protection IP65/NEMA4. Door thickness 2-12 mm

52535 95,99

* Hook closes automatically. Flap cannot open by itself when Push Lock is open

Push Lock Locks

Push lock to open from the outside

Grey	50 pcs .	532701	249,-	1 pc .	53270	7,10
① Brown	50 pcs .	5327001	249,-	1 pc .	532700	7,10
② Gold	50 pcs.	532721	349,-	1 pc.	53272	10,20
③ Nickel matt	50 pcs.	5327051	339,-	1 pc .	532705	9,20
④ chrome matt				1 pc	53269	10,31

Knob for push lock chrome polished 532790 2,55

⑤ Rosette for 13 mm wood thickness

Silver matt 50 pcs 532773 64,99 1 pc . 53277 2,70

Rosette for 16 mm wood thickness

Chrome polished 1 pc. 532791 1,80

Rosette for 19 mm wood thickness

⑥ Chrome polished, square 1 pc .532792 3,25

Silver matt 50 pcs. 532781 75,- 1 pc .53278 2,50

- One-hand operation

- Small, round, no protruding parts

- For 15 mm panel thickness

- Also with internal locking (e.g. toilet room)

- When pressed, the knob springs forward and serves as a handle

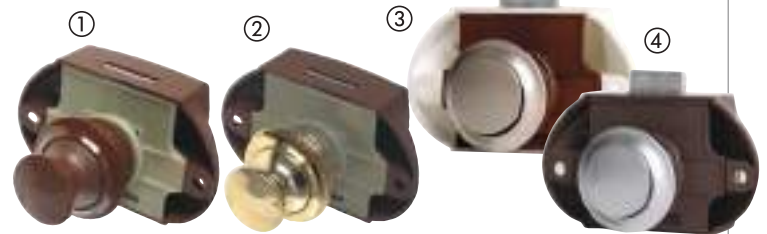

Push Lock Mini & Snap Mini

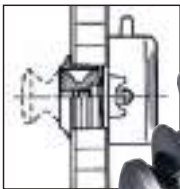

Silver matt 1 pc. 53274 9,10

50 pc. 532741 366,-

White 1 pc. 532743 5,99

50 pc. 5327431 205,-

Rosette for Push Lock Mini chrome polished, for 16 mm wood thickness

532772 1,59

Like Push Lock mini, but also keeps closed without pressing the button. Door must first be locked by pressing a button before driving

50 pieces 1 piece

Silb.Matt 5327611 375,- 532765 9,98

Gold 5327661 349,- 532766 9,98

Brown 5327601 185,90 532760 6,10

Knob for Push Lock mini + Push Snap mini chrome polished

532771 2,-

Push Lock for the wet room

Turning bar set



Push Locks, to open from outside + inside

50 pieces 1 piece

Grey 532711 399,- 53271 10,20

Brown 532712 399,- 532710 10,20

Gold 532731 575,- 53273 13,30

Silvermatt 532716 494,- 532715 13,30

Espagnolette set for Push Lock locks

(Not Push Lock Mini)

Brown 532750 8,79

White 532753 7,98

To open with just one hand movement



Furniture snap locks for door thickness 12-18 mm

Material plastic

Size 55 x 59 mm

① Matt Chrome/Black 52498 12,99

② Matt Chrome 52499 12,99

Size 36 x 59 mm:

③ Matt Black 52491 9,98

④ Matt Black/Chrome 52496 9,98

⑤ Matt Chrome/Black 52494 9,98

⑥ Matt Chrome 52497 11,-

Push Lock locks for door thickness 14 - 16 mm

Metal version

① Frame matt, knob chrome gloss 55 x 55 mm, for lock Mini 53408 13,99

② Shiny chrome, 40 x 30 mm, for lock Mini 53403 7,98

③ Shiny chrome, 60 x 27 mm, for lock Maxi 53405 12,99

Plastic version

④ Polished chrome, 34 x 34 mm, for lock Mini 53402 3,99

⑤ Shiny chrome, 35 x 35 mm, for lock Mini 53406 3,99

Chrome glossy, 35x 35 mm, for lock Maxi 53407 3,99

⑥ Shiny chrome, Ø 35 mm, for lock Mini 53404 3,99



FURNITURE MAKING ACCESSORIES



Ventilation grille

4,90

Grille with rotatable blades. Outer Ø 164 mm, mounting Ø128 mm, installation height approx. 10 mm

White	53033	4,90
Black	53034	5,49



Ventilation grille with shaft

Outer dimension 94 x 93 mm, mounting Ø78 mm. Shaft height approx. 61 mm. Mounting height approx. 10 mm

White	53035	4,90
-------	--------------	-------------



Ventilation grilles

White screw-on grilles with louvres. UV-resistant ABS. Sealing compound is already applied. Installation height approx. 14 mm. Screws included

142 x 80 mm	53036	5,49
142 x 127 mm	53037	5,90
264 x 127 mm	53038	6,90

Ventilation grille round



Ø outside 100 mm, inside 76 mm

Brown	53007	5,96
White	53008	5,75

Ø outside 145 mm, inside 120 mm

White	53012	6,28
-------	--------------	-------------

Sliding fan



Plastic, 8 holes (countersunk), 250 x 70 mm, ivory **53022**
6,28

Floor fan



Plastic, natural, outer Ø 60 mm, ventilation passage = L 7 cm². Shaft length 55 mm **53042**
4,15

Furniture ventilation

For cabinet ventilation, prevents Condensation in cabinets

Ø 60 mm, cream	53016	1,05
Ø 60 mm, grey	53017	1,05
Ø 32 mm, cream	53018	1,05
Ø 32 mm, grey	53019	1,05



Ventilation grille with mosquito net

Plastic, White
150 x 200mm **53027** **7,14**

Ventilation grille



"Luxus" made of aluminium for refrigerator or furniture ventilation in white 400 x 80 mm
53021 **17,26**



For heating systems

Plastic, silver

oval	205 x 40 mm	53040	5,49
angular	250 x 50 mm	53041	4,80



385 x 220 mm plastic, Ivory **53023** **12,25**



365 x 170 mm, plastic Ivory **53025** **18,74**

Aluminium gill plates



For outdoor ventilation for refrigerator ventilation or the like

① 255 x 115 mm	53000	10,50
② 360 x 115 mm	53001	12,72

③ for gas box ventilation. Ø100cm². Can be fitted in conjunction with 53005. High-gloss anodised aluminium **53004** **17,10**

Hooks and holders

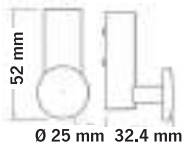

Metal hook chrome-plated
53439 6,40



Single hook metal
Silver 53342 1,70



Wall hook
Dimensions: 5,3 x 5,3 x 1,3 cm
Black 53590 7,98



Coat hook, plastic
with fold-out handle
Chrome 533381 9,06

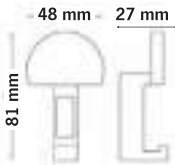

Metal hook
Chrome-plated 53438 9,31



Coat rack double hook
Metal. Dimensions 65 x 70 mm
chrome 53333 3,72



Wall hook plastic Hewi 40
mm, light grey
53328 7,41



Double coat hook chrome-plated metal
53340 13,90

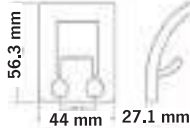

ABS plastic, chrome-plated
53435 3,50



Coat hook Style
Chrome high gloss
Dimension: 107,5 x 64,5 x
38,5 cm 53349 6,99



Coat hook
High-gloss chrome
Dimension: 5 x 5 x 4,5 cm
53354 8,84



Coat hook
Metal chrome plated
533401 4,61



Body-Hinged hook
Hook made of zamak in chrome gloss,
screw-on bearing made of plastic,
Length 8 cm 533340 13,83
Length 17 cm 533341 20,22



Recessed folding hook
for recessing into the wall, dimen-
sions: 8,8 x 2,2 x 1 cm
60126 12,74



Coat hook
foldable, on plastic base, hooks
made of zamak, silver matt Di-
mensions: 7 x 2,5 cm
53356 13,21



Coat hook
foldable, chrome-plated Dimen-
sions: 8 x 2 x 1,3 cm
53357 7,03

Damper



Noise dampers 20 pcs
8 mm 52231 5,99
11 mm 52232 6,20

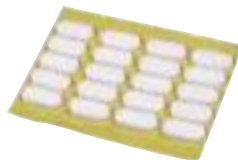

Felt pad
20 pc
52230 2,99



Rubber vapours
light grey, 10 pcs
52240 3,90

Clothes rail pull-out

Steel nickel plated
Length: 250 mm
53325 6,82



Gallery tube

Ø 10 mm
Length: 100 cm,
53320 5,95

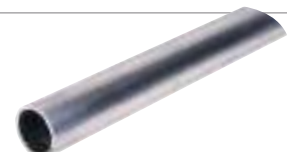

FURNITURE MAKING ACCESSORIES



Complete roller shutter door set **CARBEST** INNOVATIONS FOR MOBILE LIFE

- For building a roller shutter door that opens up
- For maximum door size of 100 cm height and 60 cm width
- Enables opening even in confined spaces
- Complete with cut-to-size roller shutter, rails and panel

The guide rails, roller shutter mat and retractable panel can be cut to the required door size and cabinet depth. Material: plastic.

Roller shutter door set

consisting of:

- 1 x Roller shutter mat with handle strip, H 100 x W 60 cm,
- 4 x Guide rails for screw-on, L 100 cm,
- 4 x Guide bends 90° to screw on
- 1 x retractable cover, L 100 cm.

Silver 53044 83,99

Structure, Beige 53045 83,99

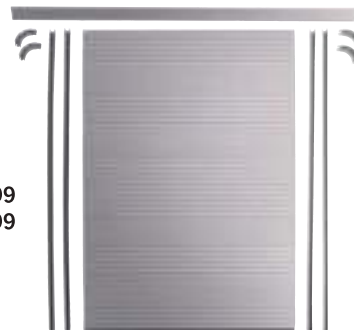

Flap Lifting Fitting HSB

- Hinge system for parallel lifting of flaps
- Space-saving opening in narrow aisles
- Can also be used with wall cabinets
- Width can be shortened as required from 60 to 120 cm
- For flap heights up to max. 40 cm

The HSB swivel fitting can be used to open both flaps in the base area and flaps of wall cabinets smartly. In the case of wall cabinets, ensure that there is sufficient space above the cabinets. The weight of the flap front must not exceed 7 kg.

53362

127,69

Mini pharmacist pull-out with 2 shelves

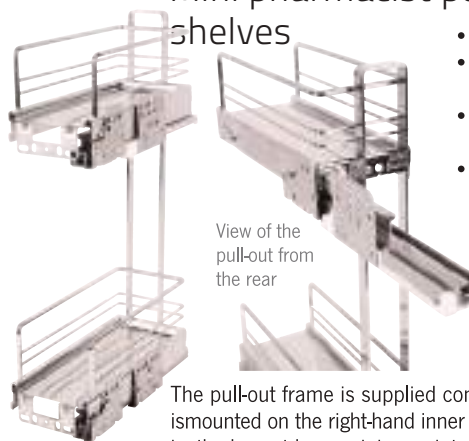

- Perfect for narrow cabinets
- Drawers with ball bearings and soft-close system
- Chrome-plated metal frame with railing
- Furniture front individually attachable and adjustable

The pull-out frame is supplied complete with the pull-out rails. It is mounted on the right-hand inner side wall of the cabinet. The cabinet body must have minimum internal dimensions of H 47 x W 12 x D 28 cm. The cabinet front is mounted on the shelves and can be aligned with screws.

52320

142,-

Drawer runners

- Narrow design, together only approx. 25 mm wide
- Loadable up to 30 kg
- Very good running properties, easy to unhinge

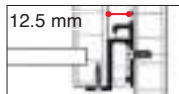
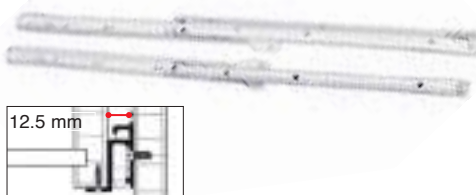

Partial extension pull-outs

300 mm, pair	53120	13,90
350 mm, pair	53378	7,51
400 mm, pair	53376	6,41
550 mm, pair	53126	12,90

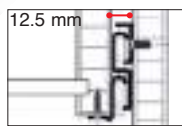

Full extension runners detachable

300 mm, pair	53370	27,19
400 mm, pair	53371	29,27
500 mm, pair	53372	32,53



Full-extension drawers

Load capacity 30 kg, Soft-Close-Automatic

300 mm, pair	53113	40,-
350 mm, pair	53102	40,-
400 mm, pair	53105	45,90
450 mm, pair	53103	46,90

Mounting catch set (not shown) for these pull-outs
53114 7,98



Image similar

NEW
2022

Rollout Slider Gigant

The heavy duty slides for extreme loads

- High load capacity
- Perfect for building rear extensions



Single pull-out for heavy load

can be loaded up to max. 100 kg. Not detachable.

500 mm, pair	53381	59,73
700 mm, pair	53380	65,16

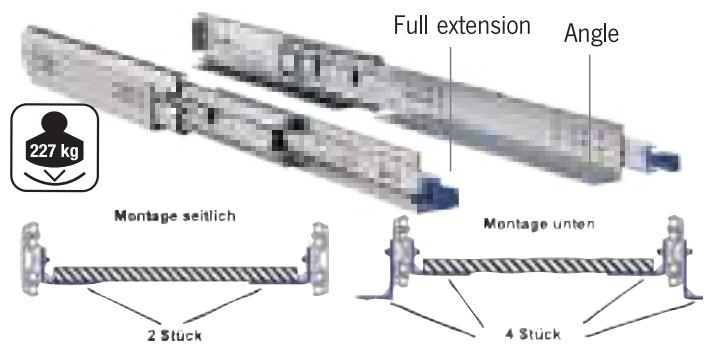

Full-extension runner with mechanical lock*

when retracted. Steel. Max. load 227 kg. Cannot be unhooked.

559 mm, pair	533000	100,-
711 mm, pair	533001	139,99
965 mm pair	533002	179,90

Bracket for mounting full-extension runner: 559

mm, 2 pieces	533004	23,99
711 mm, 2 pieces	533005	29,99
305 mm, piece	533003	12,99



Image similar

Full-extension slide, galvanised steel, max. 227 kg

739 mm, pair	533007	99,90
--------------	---------------	--------------



Full-extension Soft-Roll, steel

can be loaded up to max. 110 kg. Not detachable.

700 mm, pair	533006	69,90
--------------	---------------	--------------

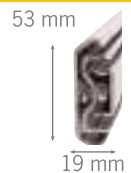

Image similar

Furniture pull-outs

Partial-extension runner with ball bearings

large extension length and drawer width, guide can be milled in. Can be loaded up to 12 kg, cannot be unhooked

278 mm, pair	53382	10,60
342 mm, pair	53383	11,-

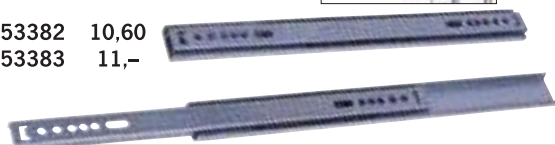
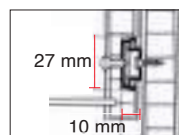

Partial-extension runner

Galvanised steel, ball bearing mounted. Can be unhooked by means of separating lever, with retaining catch for locking in closed position, can be loaded up to 35 kg. With self-closing device. 400 mm, pair **53387 24,50**



SWIVEL TABLE FRAMES

FIG. SHOWS
**U-SWING-
TABLE
COMFORT**
57120



E.g. swinging the table out of the vehicle.

In Reimo vehicles we use the U-swivel tables in Nirosta.

Swivel table standard

Inexpensive frame
Height approx. 72 cm
Swivel range approx. 40 cm
57111 53,90



Swivel table comfort

With flat mounting plate (adds only 10 mm)
For accommodating the table top in the smallest of spaces.
Height approx. 72 cm
Swivel range approx. 40 cm
57129 72,24



Swivel table frame made of aluminium

for wall mounting. Column and table support can be rotated.
Column Ø approx. 40 mm .
Height 75 cm.
57042 160,-



U-swivel table

For mounting on smooth-side surfaces, e .g.under protruding seating surfaces. Stable due to additional support, with flat mounting plate
Height approx. 72 cm.
Swivel range approx. 40 cm.
57126 107,89

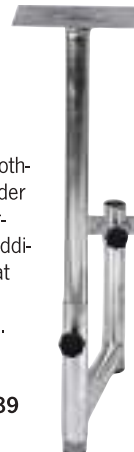

U-swivel table comfort

as 57126, but with additional swivel range of 30 cm due to curved table column
57120 94,90



TABLE COLUMNS / LIFTING TABLE FRAME



Standard table column

Very stable table column for large table tops with rotating table support and anodised screw-on rosette on the base. Column Ø approx. 60 mm . Height approx. 67 cm.
57044 **159,90**



Table column retractable

Height adjustment by gas pressure damper from approx. 36.5 - 70.5 cm. Column Ø approx. 60 mm . Table top support rotatable, for large tabletops. Column goes approx. 12 cm through the floor.
57046 **264,-**



retractable

Lifting table frame

Easy height adjustment. from 30 - 70 cm. folding mechanism.

Length: 60 cm, foot width

Light grey **57060** **154,43**
 Brown **570600** **154,43**

Length: 75 cm, foot width: 60 cm.

Light grey **57062** **154,43**
 Brown **570620** **154,43**
 Anthracite **570621** **153,36**

① Table extension fitting

The extendable fitting can be used to hold folding table tops can be held. If folded in, the fitting can be pushed back in again can be pushed in again. Aluminium, bronze anodised and black plastic,
 Length: 250 mm **57025** **9,53**



Available in 2 frame lengths. All frames height adjustable adjustable from 30-70 cm.

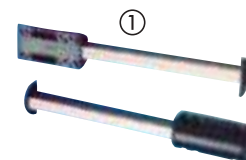

TABLE FEET / FOLDING TABLE FEET



Swivel table feet in 2 heights

- Swivel-out mechanism for table extension through lower plate
- Subdivision of the base for bed construction
- Aluminium frame

A 2nd plate can be mounted underneath the normal table top, which can be turned out if required. With locking mechanism. Ideal for a base plate up to 100x50 cm and a rotating plate up to approx. 50x70 cm. (Dimension depends on free space).

Height to lower edge of upper table top 700 mm, 225. height with lower part removed 313 mm, lockingpoint at 0°, 135°, 180°

57163 99,90

Height to lower edge of upper table top 756 mm, heightwith lower part removed 354 mm, locking point at 0°, 135°, 180°

57162 99,90



Folding table feet can be folded down at the top

With push button lock
Material: aluminium
Matt silver anodized
Height 72 cm
57070 21,57

Material: Aluminium
Silver anodized
Height 67,5 cm
57027 25,20

Height adjustment screw
for table base 57027
57029 4,50

Very stable.
In folding position only
5 cm high.
Material: metal
Height 67,5 cm
Anthracite metallic
57020 25,45
Light grey (RAL 7035)
57014 25,45



Folding position:
Height 5 cm

Height adjustable with-
push button lock.
Material: aluminium
Matt silver anodised.
Without stand
Height 55,5 - 76,5 cm
57076 26,85
With stand
Height 59 - 78 cm
57078 33,94



Folding table feet can be folded down in the middle



① With push button locking. Material: matt silver anodised aluminium .
Joint in the middle at approx. 31 cm, total height 74 cm.

57074 23,12

② Material: Aluminium silver anodized.
Joint in the middle at approx.
31.5 cm, total height 67.5 cm.

57028 28,14

Height adjustment screw
for table base 57029
57029 4,50

Single table leg

To be released from the holder at the push of a button. Height approx. 70 cm
Light grey **57000 8,51**

Table foot holder
As spare part or second mounting.
Black **57001 4,25**

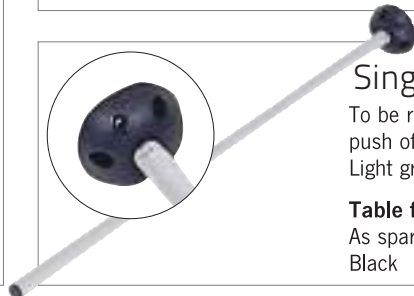

TABLE COLUMN / TABLE SLIDE RAILS



Table column & mounting rosettes



- For free-standing tables with removable table column
- Easy to store
- Tilt and wobble resistant
- Table top can be included in the hinging surface

Column height ca. 70 cm, Ø ca. 6 cm.
Material: chrome 57031 19,90

- ① Fixing rosette to screw on 57036 6,70
- ② Fixing rosette for recessed mounting 57038 6,70

① Van wall folding table height adjustable 600x460 mm 57003 291,72

② Folding table leg anodised aluminium, height: 721 mm 57004 228,36

Table slide rails for wall mounting



Additional rails
Length 10 cm each

Table slide rail stable

Table top can be moved by lifting. Locking positions can be determined by self-made holes. Rail with end pieces and 2 suspension pieces, anodized aluminium with silver-grey piping.

Length 100 cm 57030 38,90

Additional slide rails for bed position

2 rail pieces of 10 cm each. 57032 12,90

Table slide rail STILO

Oval aluminium tube, silver anodised. Black fastening elements. Table can be moved by lifting and locked in too the grid. Length 950mm,

57034 37,98

Table suspension fitting

Simple mounting option for small to medium table tops. Quick mounting and dismantling of the table top.

Brown, 2 pieces 57051 5,99

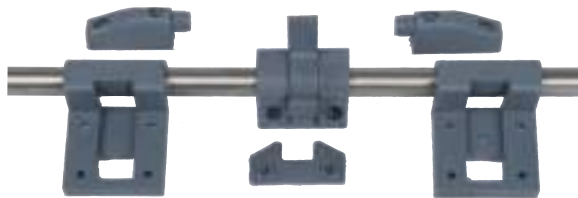

Table slide rail with stainless steel mounting tube

Quick sliding and unhooking of the table top allows good access to benches and storage boxes, as well as quick bed assembly. Lockable and fixable sliding safety device. Can be shortened as required

Length 100 cm 57055 21,99



QUICK Clip table slide rail

2 wall rails for hanging the table top and 2 Quick Clip table top fasteners. The top can be moved or unhooked at the touch of a button. The 2 rails can be used e.g. for table and bed position.

Dimensions of rails: 70 cm and 50 cm 57056 42,55

FOAM / ACCESSORIES

- We manufacture upholstery, covers, curtains and tent bellows of all kinds according to your wishes
- With zippers, Velcro or for tacking on
- Versatile for motorhomes, caravans, weekend houses, boats and much more
- Convince yourself of our high quality offer



REIMO manufactures cushions according to your specifications, also with foreign materials. Foam mouldings can be supplied to order.

1. Material:

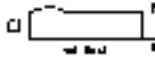
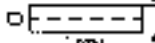
-  Standard foam, density: 35kg/m³
-  Foam with thigh padding
-  2-layer foam with different hardnesses

2. Upholstery:

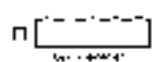
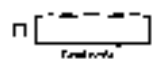
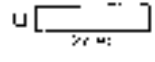
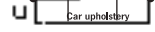
-  Luxury upholstery with quilting (spacing 10 cm)
-  Upholstery with covered upholstery buttons
-  Smooth standard upholstery
-  Car upholstery, pull-in strips and all-round piping

3. Shape & dimensions:

-  Please do not forget to specify the dimensions or make a template. The thickness of the foam is also important. Choose from our upholstery fabrics.

Foam per^{m3}
 In cut-to-size approx. 2-3 weeks delivery time. For extreme loads. Volume weight approx. 35 kg/m³
Price per^{m3} **55010** **615,99**
 e.g.: Dimensions 200 x 80 x 8 cm = 0.128^{m3}

① Pull-in strips

For high-quality topstitching; is sewn on the inside with a topstitch seam, pulled through the slit foam and tensioned. The cover tightens in this area, which results in a clear optical contrast of the quilting seam.

piece, 360 mm long GP 8,31/1 m **54910** **2,99**

② Thigh pad 124 x 18 x 3 cm

For gluing onto the front edge of the seat. You sit more comfortably and achieve a professional look, especially if you use pull-in strips.

GP 45,00/1 cbm **59130** **14,35**

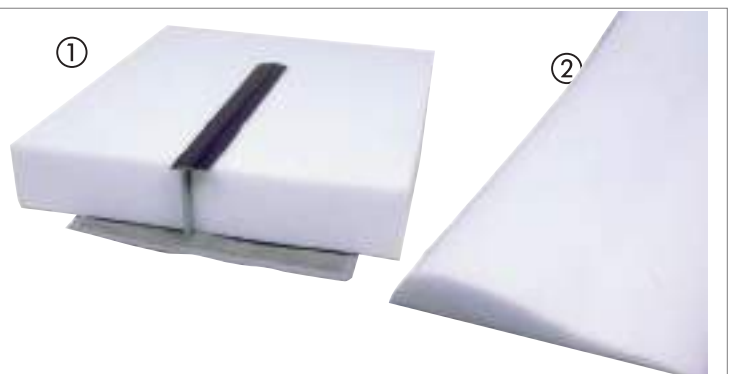

Foam cuttings

Foam sheets

As raw material for self-cutting (e.g. with electric meat knife) for upholstery group. Volume weight 35 kg/m³.

200 x 150 x 3 cm	GP 810,00/1 cbm	55006	105,70
200 x 150 x 4 cm	GP 749,92/1 cbm	55007	130,50
200 x 150 x 6 cm	GP 832,78/1 cbm	55008	217,35
200 x 170 x 7 cm	GP 749,58/1 cbm	55016	260,85
200 x 150 x 8 cm	GP 666,25/1 cbm	55002	231,85
200 x 170 x 8 cm	GP 666,30/1 cbm	55003	260,85
200 x 150 x 10 cm	GP 666,33/1 cbm	55004	303,-
200 x 170 x 10 cm	GP 676,18/1 cbm	55005	333,35

Foamspecial

Ideal for SD bedVolkswagen T4 (until 2003).

108 x 187 x 4 cm	GP 999,25/1 cbm	21129	120,-
------------------	-----------------	--------------	--------------

Foam 2-hard, bottom hard, top soft

200 x 150 x 10 cm	GP 833,00/1 cbm	55022	362,36
-------------------	-----------------	--------------	---------------

Upholstery wadding, thickness approx. 25 mm, approx. 235 g/m² laminated on fabric. Professionals glue a layer of upholstery wadding onto the foam with spray adhesive all the way around the edges.

100% polyester , 115 cm wide., rm	55020	13,39
--	--------------	--------------

Spray Adhesive Super

Bonding of all kinds of foam with high instant adhesive power. Heat resistant up to 90°C.

50013	21,99
--------------	--------------

Heat resistant up to 70°C

50011	12,-
--------------	-------------



Zippers

Endless zippers by the meter

① Light grey 3 mm, per rm	55050	3,51
Black 3 mm, per r	55053	3,51
② Black 5 mm, per rm	55056	4,30
Rust brown 5 mm, per rm	55063	3,70

Zipper for zippers yard goods

③ Chrome-plated 3 mm, for 55050 and 55053	55055	0,99
Black 5 mm, for 55056, double zipper	55057	1,99

Zippers fixed lengths 100% polyester, rot-proof

L 90 cm, grey, divisible	55051	5,88
L 170 cm, grey, divisible	55052	8,10
④ L 175 cm, white, divisible, double zipper	55061	12,50
L 210 cm, white, divisible, double zipper	55062	13,49

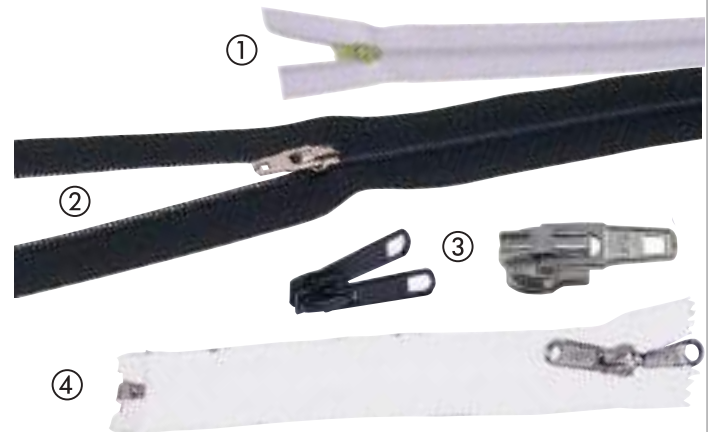

Velcro and adhesive tapes

Ideal for attaching cushions to folding benches or U-shaped seating groups.

Velcro tape Adhesive + fleece 20 mm wide, 5 m long
White GP 1,60/1 m **563003** **7,98**

Velcrotape 20 mm wide, 5 m long, self-adhesive (adhesive tape + fleece tape).

White	GP 2,70/1 m	56305	13,49
Black	GP 2,70/1 m	56317	13,49

Ditto, heat resistant up to 120°C

Black	GP 4,30/1 m	56319	21,50
-------	-------------	--------------	--------------

Adhesive tape 20 mm wide, 5 m long, rough.

Self-adhesive

Black	GP 1,80/1 m	56324	8,98
-------	-------------	--------------	-------------

Fleece tape 10 mm wide, 5 m long.

Grey	GP 2,80/1 m	56334	13,99
------	-------------	--------------	--------------

Special Velcro tape 20 mm wide

Front side adhesive tape, **Back side** fleece tape. Suitable for joining 2 pieces of padding (etc.). Price per running meter.

Black	56310	4,99
-------	--------------	-------------



Velcrotapes

Consisting of rough adhesive tape and soft fleece tape. For joining different materials. Reimo recommends heat-resistant Velcro tape for use on sheet metal in vehicles. Individual adhesive tapes are good for holding somewhat rougher cover materials on seat boxes. Normally Velcro tapes are stapled to the substrate. For sheet metal and hard surfaces, use self-adhesive hook and loop tape. 2 pieces of upholstery can be easily connected with the special Velcro tape.

AUTOMOTIVE UPHOLSTERY FABRICS

Upholstery fabrics for motor-home, caravan and car

You are sure to find what you are looking for in our wide range of upholstery fabrics. Whether it is car fabrics from vehicle manufacturers, or various easy-care fabrics from our finishing area, here you are sure to find what you are looking for

Choose from different colours and surfaces! The automotive fabrics offered here are all tested and suitable to withstand even heavy use in the vehicle.



New Wave

Soft, elegant upholstery fabric with a suede look. Durable and easy to clean. **Material:** 100% polyester, flame retardant, washable at 40°C. Weight: 730 g/lfm. **Abrasion value:** 40000 Martindale*

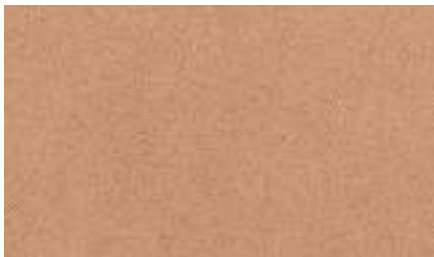

New Wave Beige, W 140 cm
rm **54036** **27,91**
GP* 19,94



New Wave Light grey, W 140 cm
rm **54037** **27,91**
GP* 19,94/



New Wave Anthracite, W 140 cm
rm **54038** **27,91**
GP* 19,94/



Upholstery fabric brown
1mm laminated, W 140cm
rm **54097** **19,99**
GP* 14,28/ 1 sqm



*Martindale method

The Martindale method is the most commonly used method to determine the abrasion resistance of textile fabrics, especially upholstery fabrics.

	soft upholstery	hard upholstery
Private use	10.000 Martindale	15.000 Martindale
Office use	25.000 Martindale	35.000 Martindale
Public	30.000 Martindale	40.000 Martindale Local public transport

Nubuclassic - Microfibre fabric with fine grain

Noble and at the same time robust cover fabric in suede look with fine grain. Hard-wearing and easy-care thanks to the use of nanotechnology

Material: 47% PC, 30% PA, 15% PE, 8% CO,
Abrasion value: 60000 Martindale*



Nubuclassic Anthracite, W 140 cm
rm **540691** **35,89**
GP* 25.64/ 1 sqm



Nubuclassic Light Brown, W 140 cm
rm **54068** **35,89**
GP* 25.64/ 1 sq

Imitation leather in 3 quality levels

- Flame retardant
- Water repellent
- Usable width at least 140 cm,
- Material surface 100% PU, underside 75% PES and 25% cotton

Madryt:

Weight 400 g/m² (+/- 10%), thickness 0.9 mm (+/- 3%)
Abrasion resistance: 102,400 Martindale



Black
rm 51026 16,99
GP* 12,14/ 1 sqm



Slate
rm 51027 16,99
GP* 12,14/1 sqm



Grey
rm 51028 16,99
GP* 12,14/1 sqm



Brown
rm 51029 22,90
GP* 16,36/ 1 sqm

New Outlander:

Weight 420 g/m² (+/- 10%), thickness 0.9 mm (+/- 3%)
Abrasion resistance: 102,400 Martindale

Santiago:

Weight 450 g/m² (+/- 10%), thickness 0.95 mm (+/- 3%)
Abrasion resistance: 51,200 Martindale



Black
rm 51040 21,90
GP* 15,64/ 1 sqm



Light grey
rm 51041 21,90
GP* 15,64/ 1 sqm



Beige
rm 51042 11,90
GP* 8,50/ 1 sq



Cognac
rm 51043 21,90
GP*15,64/ 1 sqm

Automotive Leather



Noble and at the same time robust cover fabric in genuine leather. Durable and easy to clean. Flame retardant, lightfast level 6. 1.2 mm thick

Material: genuine leather, **abrasion value:** 60000 Martindale*



Upholstery variant "Leather"
Combination of black and



Leather beige, Price/m²
540831 79,-



Leather grey, Price/m²
540832 79,-



Leatherblack, Price/m²
54083 79,-

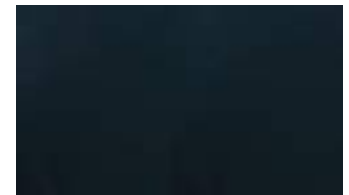

Leather dark blue, Price/m²
54072 89,-

You will find exclusive upholstery leathers in various colours on our website www.reimo.com

AUTOMOTIVE UPHOLSTERY FABRICS



Original automotive upholstery fabrics

Original automotive upholstery fabrics meet the highest automotive-specific requirements defined by vehicle manufacturers for passenger cars and commercial vehicles.

Extremely high abrasion resistance, high lightfastness and flame retardancy. Easy to clean. These properties make these materials particularly suitable for continuous use and high stresses, such as those encountered in a motorhome used for everyday purposes.

Picture shows Mercedes bench with Tunja/Uni Black cover

Upholstery fabrics for Mercedes Vito



Caluma original fabric for MB Vito, B 150 cm, flat weave made of polyester, polyurethane, nylon.
rm **54088** **62,90**
GP* 41,93/ 1 sqm

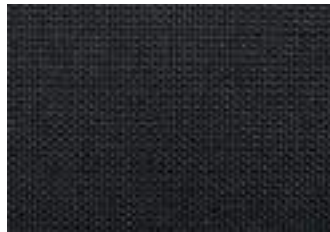

Vito, W 165 cm, flat weave in brushstroke look. 50% polyester, 50% polyacrylic.
rm **54004** **34,90**
GP* 21.15/ 1 sq

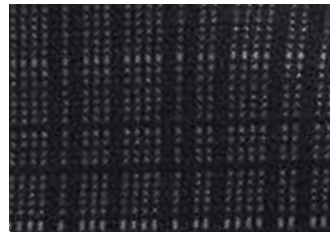

Tunja original fabric for MB Vito, W 182 cm, flat weave 100% polyester
rm **54016** **49,90**
GP* 27.42/ 1 sq

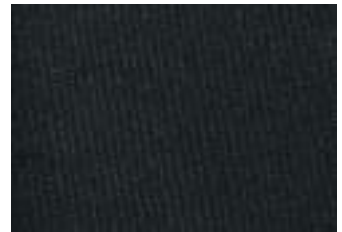

Black original fabric for MB Vito, W 160 cm, flat weave made of 100% polyester
rm **54017** **45,90**
GP* 28.69/ 1 sq

Uni Black Original fabric for MB

Upholstery fabrics for Ford Transit

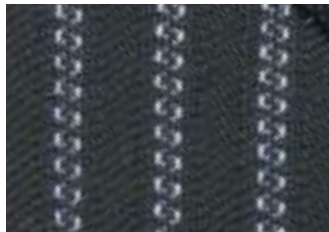

Blue Stripe series fabric Ford, W 165 cm, 2 mm foam laminated, 100% polyester
rm **54018** **49,90**
GP* 30, 24/ 1 sqm



Trend Ford series fabric, W 165 cm, 2 mm foam laminated, 100% polyester
rm **54019** **39,89**
GP* 24.18/ 1 sq



Picture shows bench with Trend/Luxe cover

Upholstery fabrics for Opel Vivaro (all 100% polyester)

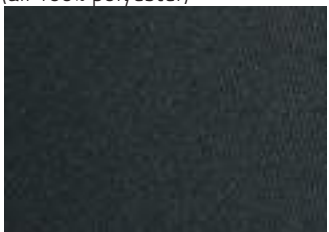

Uni black, standard fabric Opel, W 160 cm, 2 mm foam laminated
rm **54024** **49,90**
GP* 31,19/ 1 sqm

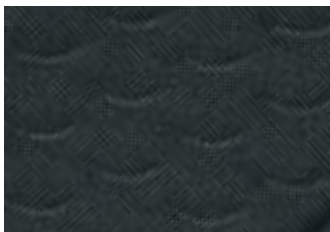

Black scale, Opel series fabric, W 180 cm, 1 mm foam laminated
rm **54011** **49,90**
GP* 27.72/ 1

Upholstery fabrics for Hyundai (all 100% polyester)

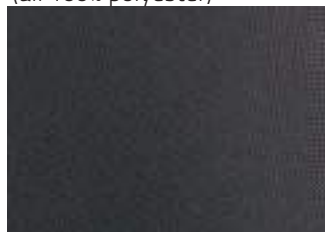

Classic dark grey B 180 cm, 3 mm foam laminated
rm **540257** **33,90**
GP* 18.83/ 1 sqm



Classic Grey, Series Hyundai, W 180 cm, 3 mm foam laminated
rm **540462** **29,90**
GP* 16.61/ 1 sq

AUTOMOTIVE UPHOLSTERY FABRICS

Upholstery fabrics for Volkswagen (all 100% polyester)

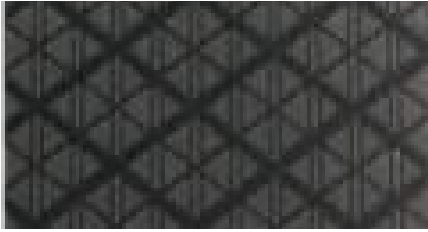

Quadratic Series fabric VW T6.1, W 160 cm,
3 mm foam laminated,
rm **540250** **32,90**
GP* 20.56/ 1 sqm

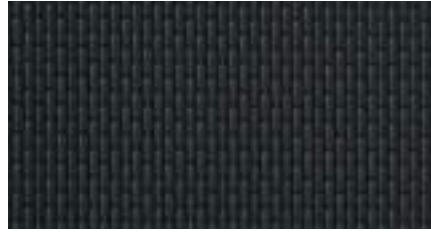

Bricks Series fabric VW T6.1, W 175 cm
4 mm foam laminated. ,
rm **540253** **35,90**
GP* 20.51/ 1 sq



Double Grid Series VW T6.1, W 180 cm
3 mm foam laminated.,
rm **540259** **35,90**
GP* 19.94/ 1 sq



Inka series fabric VW T5, B 173 cm ,
2 mm foam laminated,
rm **540251** **54,89**
GP* 31.73/ 1 sqm



Tasamo series fabric VW T5, W 180 cm,
4,5 mm foam laminated.
rm **540256** **69,90**
GP* 38.83/ 1 sq



Austin series fabric VW T5 + VW T6, W 180 cm
4 mm laminated,
rm **540254** **39,90**
GP* 22.17/ 1 sq



Simora series fabric VW T6, B 170 cm,
4,5 mm foam laminated,
rm **540258** **56,91**
GP* 33.48/ 1 sqm

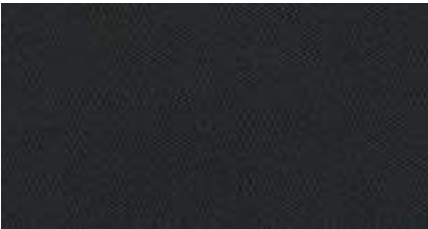

Classic dark grey standard fabric VW T5,
W 180 cm, 3 mm foam laminated.
rm **540257** **33,90**
GP* 18.83/ 1 sqm



Classic Grey W 180 cm, 3 mm foam laminated.
rm **540462** **29,90**
GP* 16.61/ 1 sq

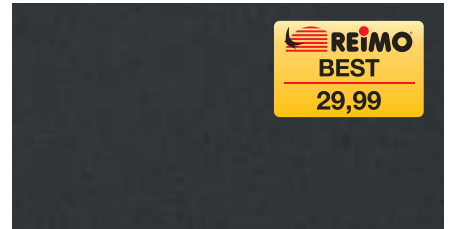

Titanium black standard fabric VW T6, W 170

cm, 1 mm foam laminated,
rm **54023** **29,99**
GP* 17.64/ 1 sq



Upholstery fabrics for Renault Trafic (all 100% polyester)

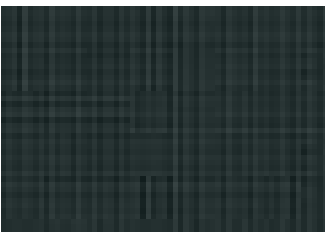

Compo series Renault, B 180 cm,
2 mm foam laminated
rm **54002** **50,90**
GP* 0.00/ 1 sqm

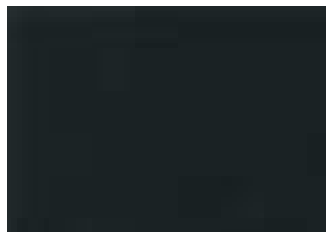

Java Natte, black Series Renault,
W 190 cm, 2 mm foam laminated
rm **54003** **32,99**
GP* 17.36/ 1 sq

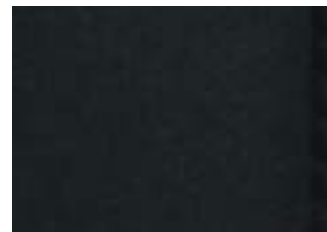

Black Uni Series Renault,
W 180 cm, 2 mm foam laminated
rm **54021** **47,99**
GP* 26.66/ 1 sq

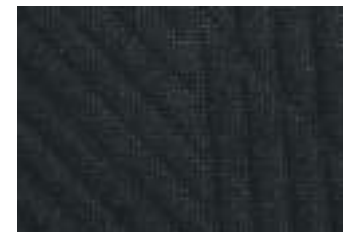

Black Patterned Series Renault,
W 180 cm, 1 mm foam laminated
rm **54020** **57,91**
GP* 36.19/ 1 sq

CURTAINS / DARKENING

Curtain set for cab darkening of VW buses



• Light and privacy screen for VW bus cab.

From year of manufacture 2003. 1-piece. This almost completely opaque darkening of the front and side windows provides an undisturbed retreat. Prevents the driver's cab from heating up and protects against unwanted views into the vehicle interior. 2-ply, grey/black **19220 159,-**

Inexpensive variant

1-ply, grey **19240 119,-**

Opaque living room blackouts for vans



- Extremely high quality double curtain
- Pre-assembled + pre-bent
- Fits well with the privacy glazing of your T5/6
- Best fabric tension, because curtain guide above and below
- Suitable for estate cars without plastic cladding

Material: 36% polyester, 32% polyamide, 23% spandex, 9% other fibres.

Scope of delivery: complete set for 5 windows with all attachments.

Fastening: with curtain rails (pre-bent) and press studs for screwing on.

Colour Inside grey, outside black:

VW Caddy until year of construction 2020 **19218 269,-**

VW Caddy Maxi until year of construction 2020 **19219 269,-**

Ford Transit Custom from 2014 **19217 259,-**

Mercedes Vito as of 2015-11-24 **19227 279,-**

VW T5/T6

Interior/exterior color:	short wheelbase		long wheelbase	
	Grey/Black	19201	279,-	19202
Bordeaux/Black	192012	279,-	192022	279,-
Cream/Black	192013	279,-	192023	279,-
Grey/Black, UK	192014	279,-	192024	279,-
Bordeaux/Black, UK	192016	279,-		
Cream/Black LR, UK	192017	279,-	192027	279,-



Renault Traffic as of 2015

Interior/exterior color:	short wheelbase		long wheelbase	
Cream/Black	192164	279,-	192167	279,-



Translucent living room blackouts for vans



- High quality fabric curtains in grey
- Pleasing ambience
- Best fabric tension due to curtain guide at top and bottom
- Suitable for estate cars without plastic cladding

Material: 36% polyester, 32% polyamide, 23% spandex, 9% other fibres.

Fastening: with curtain rails and press studs for screwing on

For 5 windows (side and rear windows)

VW T5/T6*KR from year 2003 10-piece **19231 199,-**

VW T5/T6*LR as of 2003 10-piece set **19232 119,-**

VW T5/T6 from year 2003 cab 1-piece **19240 119,-**

Clamping materials



Stretch fabric also for covering the back of benches. 100% cotton. Width 1,6 m.

Grey	54082	14,89
Black	54081	14,89



JU - soft flowing fabric

Opaque and durable super quality. Grey patterned. Material: 100% Trevira CS, flame retardant (DIN B1/M1)

Width 1,40 m GP* 17,85/1 qm **54034 24,99**



Mosquito nets

Non-rotting synthetic fabric. Can be attached with Velcro or press studs. Reliable protection against mosquitoes and vermin

Mosquito net, white 1.65 m wide . Price per running metre **56020 7,40**
 Price 5 meter **56018 29,99**
 GP* 6,00 / 1 qm

Mosquito net, Black, 1,45 m wide.
 Price per running meter **56024 16,89**
 Price 5 meter **56019 64,99**
 GP* 13,00 / 1 sqm



Curtain fastening with spiral tape

Complete set for combination vehicles for fastening your curtains in the motorhome, caravan, etc. Sufficient for 5 windows in the van
Scope of delivery: 10 pcs. mounting set for Spannfix, 10 pcs. curtain fastener, 10 pcs. snap fasteners and Spannfix light grey.

12 m tension fix set **56250 58,30**
 15 m tension fix set **56251 59,99**

Curtain fixing set
 10 m spiral tape, 20 eyelets **56253 21,40**

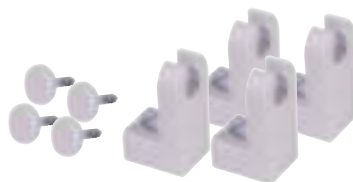

Spiral tape mounting set

Elegant wall mounting for the Spannfixband. Consists of 4 plastic angles and 4 special screws for screwing into the spiral ends.
 Light grey **562101 2,99**



Spannfix curtain tape

Practical spiral tape. Price per meter, Light grey **56220 1,92**

Curtains accessories



① **Fastening set** for curtains special (10385/10386) with 8 m curtain track and 10 press studs **10384 136,62**

② **Glider** for curtain track 56130/56105
 20 pcs **56110 5,99**
 100 pieces **561100 19,99**

③ **Glider** for curtain rail 56122/56123.
 20 pieces **56124 3,18**

④ **Plasticstop**. For track 56130/56105.
 6 pieces, white **561111 4,99**

⑤ **Plastic brakes**. For rail 56122/56123
 6 pieces, white **56125 2,98**

⑥ **Snap fasteners** for fixing curtains and mosquito nets in the vehicle. Incl. tool.
 10 pcs. **56230 9,90**

⑦ **Tenax snap fasteners** for fastening fabric, tent fabric, insulating mats, Mosquito nets etc., incl. tool.
 5 pieces **37383 17,90**

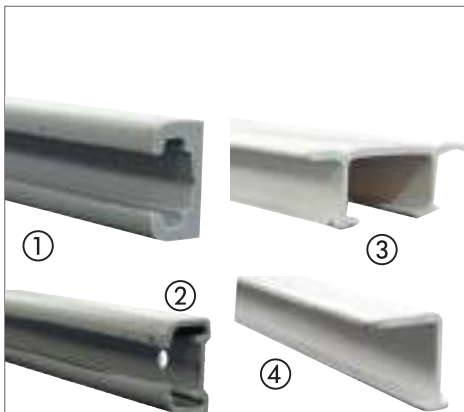

Curtain rails

① **Plastic** without sharp edges. Manufactured according to the new safety regulations for driver's cabs. Bar 2,2 m, grey **56130 GP* 4,69 / 1 m 10,52**

② **Aluminium** as above, but **natural aluminium**.
 Rod 2,6m **56105 GP* 6,50 / 1 m 16,90**

③ **2-run, plastic**, 2x T-profile, white.
 Rod 2,5 m **56123 GP* 8,00 / 1 m 19,99**

④ **1-run, plastic**, T-profile, white.
 Rod 2,5 m **56122 GP* 2,76 / 1 m 6,90**
 Rod 5,0 m **561220 GP* 2,58 / 1 m 13,74**



NEW
2022
MORE SIZES TO
CHOOSE FROM!

Washer made
of
Safety
glass



from
114,89

Stainless steel telescopic display infinitely variable

Real glass vent window - RW ECO

- 3.5 mm safety glass with dark tinting
- For wall thickness 30 mm, corner radius 75 mm
- With stepless telescopic stops
- Optional interior frame with pleated roller blind and mosquito net



WINDOWS



INNER FRAME (OPTIONAL)



Cut-out dimension (W x H in mm)	Overall dimension (W x H in mm)	Opening angle	Weight	Windows		Interior roller blind with frame	
				Item no.	Price	Item no.	Price
350x500	397x554	54°	2,7 kg	31880 *	121,90	318801	76,90
500x300	547x354	26°	2,6 kg	31881 **	114,89	318811	74,90
500x350	547x404	25°	2,8 kg	31889	124,90	318891	81,90
500x450	547x504	45°	3,3 kg	31882 *	142,90	318821	84,89
600x450	647x504	45°	4,0 kg	31870	142,90	318701	87,91
700x300	747x354	26°	3,4 kg	31883 **	134,90	318831	85,99
700x400	747x454	38°	4,1 kg	31871	169,-	318711	92,90
700x450	747x504	45°	4,5 kg	31872	175,91	318721	95,90
800x450	847x504	45°	5,2 kg	31884 *	210,90	318841	99,90
900x450	947x504	45°	5,9 kg	31885 *	214,90	318851	102,90
900x500	947x504	54°	6,3 kg	31886 *	216,90	318861	105,90
1000x500	1047x554	54°	6,8 kg	31887 *	226,90	318871	111,90

* Stainless steel telescopic stage, infinitely variable

**3-stage plastic display unit



Top price
Top Insulation
Top optics



NEW
2022
MORE SIZES TO
CHOOSE FROM!

Sliding window real glass - RW MOTION

- Best insulation due to double glazing
- Powder coated high quality aluminium frame
- Tinted safety glass pane
- For wall thickness 30 mm, corner radius 87 mm



WINDOWS



INNER FRAME (OPTIONAL)



Cut-out dimension (W x H in mm)	Overall dimension (W x H in mm)	Weight	Windows		Interior roller blind with frame	
			Item no.	Price	Item no.	Price
500x300	528x328	4,8 kg	31657	139,99	316571	72,-
500x350	528x378	5,9 kg	31650	135,90	316501	74,90
500x450	528x478	6,5 kg	31654	175,91	316541	76,90
600x350	628x378	6,2 kg	31653	158,90	316531	74,90
600x450	628x478	7,7 kg	31658	191,-	316581	82,99
700x300	728x328	6,4 kg	31659	169,99	316591	85,99
700x400	728x428	8,0 kg	31660	192,99	316601	94,99
700x450	728x478	8,7 kg	31661	207,99	316611	89,99
800x340	828x368	7,8 kg	31656	179,90	316561	94,90
800x400	828x428	8,3 kg	31651	177,95	316511	93,90
800x450	828x478	9,9 kg	31655	199,90	316551	94,90
900x450	928x478	10,8 kg	31662	215,99	316621	100,-
900x500	928x528	11,8 kg	31663	269,99	316631	101,-
960x450	988x478	10,9 kg	31652	193,90	316521	95,90
1000x500	1028x528	12,9 kg	31664	289,-	316641	109,90

REAL- GLASS- WINDOWS.

FOR REFRESHMENT
OR AS A REPLACEMENT WINDOW.



Good prospects with the Carbest real glass windows for camping buses, vans and motorhomes.

The retrofittable safety glass windows give the vehicle a noble character, increase the living atmosphere in the vehicle and visually turn a van into an estate model

The dark-tinted glazing ensures that privacy is maintained in the best possible way. Many window models are available as sliding windows and thus provide not only a lot of light but also fresh air in the vehicle.

For many different manufacturers and vehicle types available
All models on the next pages.



Legend of wheelbase abbreviations:

kR = short wheelbase mR = medium wheelbase
IR = long wheelbase eIR = extra long wheelbase

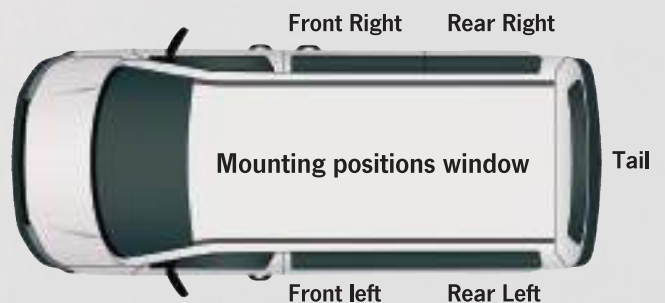

Tinted SAFETY GLASS WINDOWS

for VW Transporter T4/T5/T6/T6.1 and VW Caddy



Images similar



Vehicle	Position, wheelbase	Overall dimension W x H	Weight Rigid/sliding	Rigid windows Part no.	Price	Sliding window Part no.	Price
VW T4 My. 1990-2004	Front Right, kR + IR	1126 x 523 mm				31503	195,90
	Front Left, kR + IR	1126 x 523 mm				31504	195,90
	Rear Right, kR	967 x 522 mm		31505	89,99		
	Rear Left, kR	967 x 522 mm		31506	89,99		
VW T5/T6 from My. 2004	Front Right, kR	1135 x 585 mm	7.0/7.5 kg	315910	89,99	31591	195,99
	Front left, kR	1135 x 585 mm	- /7,5 kg			31590	195,99
	Rear Right, kR	922 x 572 mm	5.0/6.0 kg	31599	89,99	315911	195,99
	Rear Left, kR	922 x 572 mm	5.0/6.5 kg	31598	89,99	315900	195,99
	Rear Right, IR	1257 x 570 mm	8,0/9,5 kg	315990	89,99	315912	195,99
	Rear Left, IR	1257 x 570 mm	8,0/9,5 kg	315980	89,99	315901	195,99
VW T5 My 2004-2016	Tailgate kR + IR	1445 x 575 mm	10.0 kg	316005	216,90		
VW T6/T6.1 from year 2016	Tailgate kR + IR	1554 x 562 mm	10.0 kg	31600	210,90		
VW Caddy My. 2009-2020	NEW: Front Right, kR	714 x 538 mm	5.0/6.0 kg	316021	69,90	31618	195,99
	NEW: Front left, kR	714 x 538 mm	5.0/6.0 kg	316020	69,90	31617	195,99
	NEW: Rear Right, kR	1044 x 545 mm	6,5 kg	31605	89,99		
	NEW: Rear left, kR	1044 x 545 mm	6,5 kg	31604	89,99		
VW Caddy My. 2004-2016	Tailgate kR	1257 x 591 mm	9,0 kg	316024	189,90		
VW Caddy My. 2015-2020	Tailgate kR	1377 x 588 mm	9,0 kg	316025	189,90		



AIRvent ventilation grille for CARBEST VW T5/T6 sliding window

With completely surrounding rubber piping for perfect sealing of the window.

Left, suitable for 31590 **461600** **132,28**
 Right, suitable for 31591 **461601** **132,28**











TINTED SAFETY GLASS WINDOWS

for Mercedes Vito



Images similar



Vehicle	Position, wheelbase	Overall dimension W x H (mm)	Weight Rigid/sliding	Rigid windows Part no.	Price	Sliding window Part no.	Price
MB Vito year 2004-2014	Front Right, kR + IR 	1096 x 565	7,0/9,0kg	31511	89,99	31521	195,99
	Front left, kR + IR 	1096 x 565	7.0/9.0 kg	31510	89,99	31520	195,99
	Rear Right, kR 	1169 x 521	7,0 kg	31523	95,90		
	Rear Left, kR 	1169 x 521	7,0 kg	31522	95,90		
	Rear Right, IR 	1296 x 521	7,5 kg	31513	95,90		
	Rear Left, IR 	1296 x 521	7,5 kg	31512	95,90		
MB Vito as of 2015	Front Right, kR + IR 	1100 x 570	5.0 kg			31597	195,99
	Front Left, kR + IR 	1100 x 570	5.0 kg			31596	195,99
	Rear Right, mR (5.14m) 	1195 x 531	7,5 kg	315970	89,99		
	Rear Left, mR (5.14m) 	1195 x 531	7,5 kg	315960	89,99		

TINTED SAFETY GLASS WINDOWS

for Citroën Jumpy 3/Spacetourer, Peugeot Expert 3/Traveller, Toyota Proace 2/Proace Verso and Opel Vivaro/Zafira Life, from model year 2016 onwards



Position, wheelbase	Overall dimension W x H (mm)	Weight Rigid/sliding	Rigid windows Part no.	Price	Sliding window Part no.	Price
Front Right, kR + IR 	1100 x 541	8,5 kg			31701	253,90
Front left, kR + IR 	1100 x 541	8,5 kg			31700	253,90
Rear Right, kR 	1175 x 534		31705	104,99	31703	229,90
Rear Left, kR 	1175 x 534		31704	104,99	31702	229,90
Rear door left 	735 x 495		31706	149,-		
Rear door right 	675 x 495		31707	149,-		

You will find many more Carbest windows on our homepage: www.reimo.com











TINTED SAFETY GLASS WINDOWS

for Ford Transit Custom and Renault Trafic -
for retrofit glazing of panel vans



Figure window Renault Trafic



Vehicle	Position, wheelbase	Overall dimension W x H (mm)	Weight Rigid/sliding	Rigid windows Part no.	Price	Sliding window Part no.	Price
Renault Trafic My. 2002-2015	Front Right, kR + IR 	1193 x 665	9,0kg			316012	196.-
	Front left, kR + IR 	1193 x 665	9,0 kg			316011	196.-
Renault Trafic as of 2015	Front Right, kR + IR 	1116 x 598	7,0/7,5 kg	316010	95,90	31593	216,90
	Front left, kR + IR 	1116 x 598	7,5 kg			31592	216,90
	Rear Right, kR 	919 x 571	8,0 kg	31602	84,90		
	Rear Left, kR 	919 x 571	8,0 kg	31601	84,90		
Renault Trafic My 2002-2019	Rear door right, 	670 x 623	6,0 kg	315913	93,90		
	Rear door left, 	670 x 623	6,0 kg	315914	93,90		
Ford Transit Custom from as of 7/2013	Front Right, kR + IR 	1199 x 566	7,0 kg			31595	196.-
	Front Left, kR + IR 	1208 x 566	7,0 kg			31594	196.-





























Recommended accessories:

① Edge protector	294541	19,21
② Cleaner	29415	23,12
③ Adhesive set (you need 2x per window)	294841	33,71
② + ③ Window accessories set (2x glue set + cleaner)	294000	82,90

TINTED SAFETY GLASS WINDOWS FOR MAXI VANS

NEW
2022



Vehicle	Position, wheelbase	Overall dimension W x H	Weight Rigid/sliding	Rigid windows		Sliding windows	
				Part no.	Price	Part no.	Price
VW Crafter as of year 2018	Front Right 	1492 x 713 mm	13,5 kg			31710	237,90
	Front left 	1488 x 713 mm	13,5 kg			31711	237,90
	Center Right 	1455 x 637 mm	13.0 kg			31712	237,90
	Center Left 	1455 x 702 mm	13,5 kg			31713	251,90
	Rear Right 	883 x 682 mm	8,5 kg			31714	232,90
	Rear Left 	883 x 682 mm	8,5 kg			31715	232,90
	Rear door right 	776 x 649 mm	6,5 kg	31716	115,90		
	Rear door left 	776 x 649 mm	6,5 kg	31717	115,90		
Fiat Ducato, Peugeot Boxer, Citroën Jumper from 2007 onwards	Front Right, L2 / L4 / L5 	1400 x 665 mm	9,5/10,0 kg	316190	104,90	31619	199,90
	Front Left, L2 / L4 / L5 	1434 x 665 mm	10.0/10.0 kg	316200	104,90	31620	199,90
	Center Right, L2 / L4 / L5 	1360 x 585 mm	9.0/9.0 kg	316220	104,90	31622	199,90
	Center Left, L2 / L4 / L5 	1360 x 665 mm	9,5/9,0 kg	316210	104,90	31621	199,90
	Rear Right, L5 	1126 x 665 mm	8.0/8.5 kg	316230	104,90	31623	196,-
	Rear Left, L5 	1128 x 665 mm	8.0/8.5 kg	316240	104,90	31624	199,90
	Rear door right 	826 x 665 mm	5.0 kg	31625	84,90		
	Rear door left 	826 x 665 mm	5.0 kg	31626	84,90		
	NEW: Rear door right* 	826 x 665 mm	5.0 kg	31627	84,90		
	NEW: Rear door left* 	826 x 665 mm	5.0 kg	31628	84,90		
Mercedes Sprinter from year 2007 and identical vehicles (VW Crafter My. 2007-2018)	Front Right, kR + IR 	1405 x 766 mm	13,5 kg			315002	242,90
	Front Left, kR + IR 	1408 x 766 mm	13,5 kg			315003	242,90
	Center Right, kR + IR 	1416 x 706 mm	12.0 kg	315001	126,90		
	Center Left, kR + IR 	1422 x 766 mm	12.0 kg	315000	126,90		
Mercedes SprinterMy. 2007-2018 (VW Crafter My. 2007-2018)	Rear door right 	818 x 800 mm	7,5 kg	315004	126,90		
	Rear door left 	818 x 800 mm	7,5 kg	315005	126,90		
Mercedes Sprinter as of year 2019	Rear door right 	775 x 775 mm	7,0 kg	315006	126,90		
	Rear door left 	775 x 775 mm	7,0 kg	315007	126,90		

* With recess for the 270° door hinges

¹For models 15M3/13M3/11M3 / ²For models 15M3/13M3 / ³For models15M3

SLIDING AND EXCHANGE WINDOWS

Universal sliding window

- Can be used universally on any vehicle
- Gives the vehicle a noble character and visually turns the box into a station wagon
- Tinted safety glass
- With E-mark

CARBEST
INNOVATIONS FOR MOBILE LIFE

NEW
2022

Overall dimension (W x H in mm)	Item no.	Weight	Price
460x280	31720	1,3 kg	134,90
500x350	31721	1,7 kg	159,-
500x450	31722	2,2 kg	164,90
600x350	31723	2,1 kg	169,90
800x340	31724	2,6 kg	179,90
800x450	31725	3,5 kg	189,-
900x450	31726	3,9 kg	194,90



Genuine glass sliding windows in exchange for fixed panes in OEM quality

- Fresh air in the vehicle
- Tarpaulin surface with closed window
- Green glazed replacement windows for common vehicle models
- Panes are glued in place

Replacement sliding window for VW T5/T6/T6.1

Length: 1136 Height: 581mm, Opening sliding window W: 450 x H: 370mm

Left side **31860 617,-** Right side **31861 617,-**

Replacement sliding window for Ford Transit Custom

Length: 1200 Height: 560mm, Opening sliding window W: 360 x H: 300 mm

Right side **31865 625,-**

Replacement sliding window for Mercedes Vito

Length: 1108 Height: 569mm, Opening sliding window W: 400 x H: 380 mm

Left side **31862 618,-** Right side **31863 625,-**

Replacement sliding window for Renault Trafic

Length: 1160 Height: 590mm, Opening sliding window W: 360 x H: 300 mm

Left side **31866 625,-** Right side **31867 625,-**



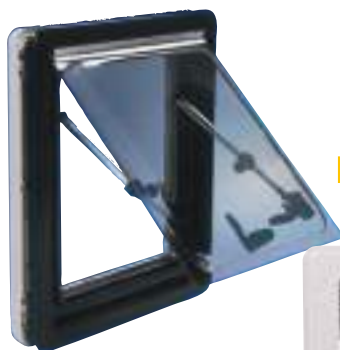

Opening window CLASSIC

- Integrated blackout system (pleated blind)
- Integrated insect screen
- Manual telescopic shutters
- Double glazed
- UV-resistant
- For wall thicknesses of 30 mm ± 1.5 mm
- Scope of delivery incl. inner frame with blackout system, insect screen and screw cover

Window and interior frame in a set

Size	Cut-out dimension	Opening angle	Overall dimension	Kg	Item no.	Price
500 x 300 mm	502 x 322 mm	32°	529 x 329 mm	ca. 3,8	318581	254,90
500 x 350 mm	502 x 352 mm	60°	529 x 379 mm	ca. 4,0	318580	275,90
500 x 450 mm	502 x 452 mm	70°	529 x 479 mm	ca. 4,2	31858	374,90
700 x 400 mm	702 x 402 mm	70°	729 x 429 mm	ca. 5,5	31859	338,90
900 x 450 mm	902 x 452 mm	70°	929 x 479 mm	ca. 7,0	31857	391,90
900 x 500 mm	902 x 502 mm	70°	929 x 529 mm	ca. 7,3	318582	376,90
1100 x 450 mm	1102 x 452 mm	70°	1129 x 479 mm	ca. 8,5	31855	433,90
1200 x 500 mm	1202 x 502 mm	78°	1229 x 529 mm	ca. 9,2	31868	465,90
1450 x 550 mm	1452 x 552 mm	70°	1479 x 579 mm	ca. 11,5	31869	497,90



ELEGANCE vent window

- Window glass is flush with the window frame on the outside
- Pane cambered on the inside
- Thermally insulated acrylic glass pane
- Plastic frame incl. inner frame
- For wall thicknesses from 25 to 40 mm
- With blackout, mosquito protection and night locking system
- Integrated blackout system (pleated blind)

Acyl glass pane is flush with the frame on the outside

Window and interior frame in a set

Size	Cut-out dimension	Opening angle	Overall dimension	Kg	Art. No.	Price
500 x 350 mm	502 x 352 mm	45°	529 x 379 mm	4,3	318500	316,90
500 x 450 mm	502 x 452 mm	45°	529 x 479 mm	5,0	318501	333,90
900x350 mm	902x352 mm	45°	929x379 mm		318507	347,90
900 x 450 mm	902 x 452 mm	45°	929 x 479 mm	7,4	318502	439,90
1100 x 450 mm	1102 x 452 mm	45°	1129 x 479 mm	10,4	318503	486,90
1200 x 300 mm	1202 x 302 mm	12°	1229 x 329 mm	8,0	318504	452,90
1200 x 500 mm	1202 x 502 mm	45°	1229 x 529 mm	10,0	318505	537,90
1000 x 800 mm	1002 x 802 mm	50°	1029 x 829 mm	12,2	318506	672,90



NEW
2022

Windows	DOUBLE GLASSED	CE (E13)	INSECT-PROTECTION	Alu	Inner frame (optional)			
					Cut-out W x H (mm)	Overall W x H (mm)	Opening angle	Weight approx.
350x500					318009	159,-	3180090	76,90
460x220					318010	146,91	31800100	72,90
500x300					318011	152,90	31800110	73,90
500x350					318000	232,89	3180000	68,00
500x450					318001	232,89	3180010	74,40
600x450					318012	204,89	31800120	88,90
700 x 300					318013	189,-	31800130	89,90
700 x 400					318002	275,90	3180020	83,90
700x450					318014	239,90	31800140	96,90
800x450					318015	262,89	31800150	104,90
900 x 450					318003	316,90	3180030	95,90
900x500					318016	304,90	31800160	114,89
1000x500					318017	324,91	31800170	117,91
1000 x 800					318004	507,90	3180040	121,90
1100x 450					318005	399,90	3180050	111,90
1200 x 300					318006	359,90	3180060	104,90
1200x500					318007	345,90	3180070	116,91
1450 x 550					318008	395,90	3180080	121,90

Vent window RW STYLE

- High quality, black aluminium frame
- Double-walled, UV-protective acrylic glass, black tinted
- Pane is curved inwards and closes flush with the window frame on the outside
- Top insulation due to double glazing
- Aluminium inner frame with pleated blind and mosquito net as option
- For wall thickness 30 mm



For thinner vehicle walls, we recommend mounting a wooden frame.

Vent window RW VAN

- Soundproofing & insulation due to double glazing - Infinitely adjustable Telescopic display unit
- Pane is curved inwards and closes flush with the window frame on the outside
- Lightweight aluminium frame, pre-curved, ideal for panel vans
- Curvature radius 5000 mm, wall thickness: 32 mm

NEW
2022
MORE SIZES TO CHOOSE FROM!



Curved Aluminium-Frame

Windows	DOUBLE GLASSED	CE (E7)	INSECT-PROTECTION	Alu	Inner frame (optional)			
					Cut-out W x H (mm)	Overall W x H (mm)	Opening angle	Weight in kg
280x380					31911 *	226,90	319111	89,90
490x500					31912*	259,90	319121	115,89
500x300					31924	211,90	319241	109,90
500x500					31919	246,90	319191	124,90
600x450					31917*	283,90	319171	99,90
600x600					31925	299,-	319251	139,90
750x455					31913*	294,91	319131	136,90
800x500-					31927	316,90	319271	134,90
818x315					31914**	263,89	319141	116,91
900x400					31918*	327,90	319181	132,90
900x450					31916*	339,90	319161	132,90
900x500					31928	339,-	319281	144,89
960x450					31910*	362,90	319101	136,90
985x465					31915*	373,90	319151	143,89
1100x 600					31926	425,90	319251	139,90

* Stainless steel telescopic stage, infinitely variable
* 3-stage plastic display unit

RW COMPACT and RW VAN can be combined well with each other on the vehicle because they have the same look.



Vent window COMFORT

- High-quality, black aluminium frame
- Flat, tinted double acrylic glazing, infinitely adjustable
- Top insulation due to double glazing
- Optional inner frame with pleated blind and mosquito net
- Opening angle up to 60° (depending on window size)

NEW
2022

High insulation
through double
glazing



WINDOWS



INNER FRAME (OPTIONAL)



Cut-out WxH (mm)	Overall WxH (mm)	Opening angle	approx. kg	Item no.	Price	Item no.	Price
350x500	380x530	60°	2,2	318100	149,-	3181000	72,90
500x300	530x330	2/17/30°	2,3	318101	134,90	3181001	65,90
500x350	530x380	2/17/30°	2,2	318102	147,91	3181002	72,90
500x450	530x480	60°	3,0	318103	174,89	3181003	85,89
600x450	630x480	60°	3,4	318104	199,-	3181004	97,90
700x300	730x330	2/17/30°	3,5	318105	174,89	3181005	85,89
700x400	730x430	2/17/30°	3,7	318106	205,91	3181006	102,90
700x450	730x480	60°	4,0	318107	224,90	3181007	96,90
800x450	830x480	60°	4,5	318108	254,90	3181008	109,-
900x450	930x480	60°	4,7	318109	279,-	3181009	119,-
900x500	930x530	60°	5,0	318110	295,91	3181010	126,90
1000x500	1030x530	60°	5,4	318111	322,89	3181011	137,90



Vent window RW COMPACT

- High-quality, black aluminium frame
- Flat, tinted double acrylic glazing, infinitely adjustable
- Pane is curved inwards and closes flush with the window frame on the outside
- Top insulation due to double glazing
- Optional inner frame with pleated blind and mosquito net
- For wall thickness 30 mm, corner radius 75 mm

High insulation
through double
glazing



WINDOWS



INNER FRAME (OPTIONAL)



Cut-out WxH (mm)	Overall WxH (mm)	Opening angle	approx. kg	Item no.	Price	Item no.	Price
350x500	378x528	63°	2,2	31890*	169,90	318901	79,90
500x300	528x328	38°	2,3	31891**	158,90	318911	78,90
500x350	528x378	40°	2,6	31901	169,-	319011	84,89
500x450	528x478	57°	3,0	31892*	193,90	318921	81,90
600x450	628x478	57°	3,4	31899*	203,89	318991	89,90
700x300	728x328	48°	3,5	31893**	193,90	318931	95,90
700x400	728x428	54°	3,7	31900*	216,90	319001	95,90
700x450	728x478	57°	4,0	31902	242,90	319021	96,90
800x450	827x478	57°	4,5	31894*	272,90	38941	105,90
900x450	928x478	57°	4,7	31895*	272,90	318951	103,90
900x500	928x528	64°	5,0	31896*	283,90	318961	113,89
1000x500	1028x528	57°	5,4	31897*	295,91	318971	115,89

* Stainless steel telescopic stage, infinitely variable
** 3-stage plastic display unit



EXCLUSIVE

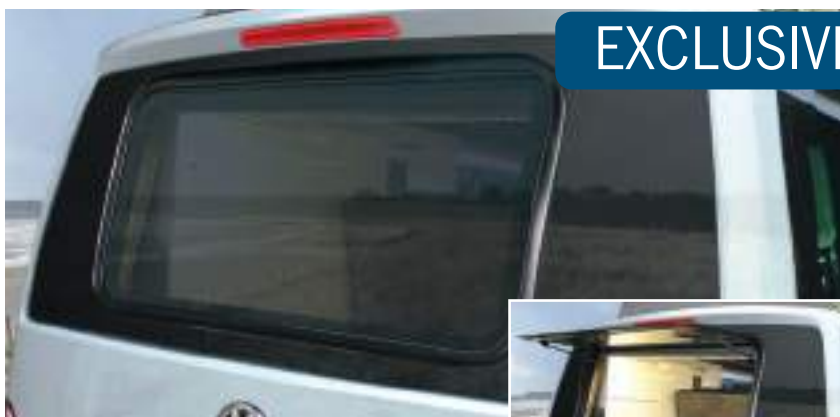

Interior trim not included, we recommend trim panels, see page 180

Reimo VW T6 & T5 rear window frame incl. S7P vent window

A hinged window especially for the VW T6 station wagon and panel van. Instead of the rear window, a GRP cover, in which the window is already installed, is glued. A possibly existing rear wiper is omitted. Excellent heat insulation through double, dark tinted acrylic glazing. Delivery only via a Reimo specialist dealer.

Folding window Seitz S7P incl. installation cover f. **VW T6/T6.1** **31299** **747,93**
Folding window Seitz S7P incl. installation cover for **VW T5** **31286** **683,73**

Duet honeycomb blind and insect screen for S7P 5000

Cosy honeycomb blind and tight flyscreen. Flat lying cassette infinitely adjustable. One-hand operation of both roller blinds
 Dometic blackout system **31324** **393,-**

Opening window for Fiat Ducato, Citroën Jumper + Peugeot Expert from 7/06 onwards



- **Optimally adapted to the contour of the vehicle**
- **Very good visual protection due to black tinting**
- **Low loss of brightness in the interior**
- **No protruding fittings - greatest possible security**
- **Thermal protection through acrylic insulating glazing**

Scope of delivery: glass, exhibitor, bolt locks as well as rubber profile

- ① Sliding door window 1051x650mm for cut-out size: 985x465mm
 2 locking bolts **32200** **419,-**
 Side window (not shown) 816x650mm for cut-out size: 750x465mm,
 2 locking bolts **32204** **307,-**
- ② Side window 566x650mm for cut-out size: 500x520mm
 2 locking bolts **32201** **245,-**
 frosted glass **32202** **257,-**
- ③ Rear window 816x650mm for cut-out size: 550x490mm
 1 locking bolt **32203** **302,-**

The above windows are suitable for panel vans
 (not suitable for replacing the original glazing)

Vent window RW REAR





- **Lightweight design without frame/suspended**
- **Best insulation due to double tinted acrylic glass**
- **Double glazing reliably protects against noise**
- **3-stage aluminium telescopic uprights**
- **Opening max. 60**
- **Optional inner frame with roller blind and mosquito net**



CARBEST
 INNOVATIONS FOR MOBILE LIFE



WINDOWS

Position	Cut-out dimension W x H (mm)	Overall dimension W x H (mm)	Opening angle	Kg	Item no.	Price	Item no.	Price
Page 	260 x 560	340 x 653	60°	1,6 kg	31920	179,90	319201	95,90
Tail 	620 x 560	700 x 653	60°	4,1 kg	31921	216,90	319211	102,90
Page 	735 x 560	814 x 653	60°	4,6 kg	31922	249,90	319221	111,90
Sliding door 	970 x 560	1050 x 653	60°	5,8 kg	31923	295,91	319231	114,89

INNER FRAME (OPTIONAL)

Rainscreen – Rain protection for sliding windows

- Transparent rain cover for side sliding windows
- Provides optimum ventilation even in rainy weather
- Can be mounted on the right and left side of the vehicle (when stationary)
- Can be used for left and right-hand drive vehicles
- Can be mounted on vehicles with or without Multirail (mounting with enclosed Velcro tape on vehicles without Multirail)
- Particularly small packing size 61 x 24 x 2 cm

Suitable for the following vehicles:

VW T5 + T6/T6.1 KR + LR estate, Caravelle, Multivan, California (all)
 Renault Trafic, Nissan Primastar/NV 300 each from 2001, Fiat Talento,
 Opel Vivaro (2001 to 6/2019), each KR + LR Citroën Spacetourer/Jumpy,
 Peugeot Traveller/Expert, Toyota ProAce Verso/ProAce, each from 2016,
 Opel Vivaro/Zafira Life, from 9/2019, all 3 body lengths, Mercedes Vito +
 V-Class, all 3 body lengths, Marco Polo, each from 2003 onwards

904494 29,90



Airvents – Ventilation systems for Carbest sliding windows

- Precisely fitting ventilation grilles for the Carbest sliding windows 31590/31591 for VW T5/T6
- Effective ventilation inside the vehicle Simultaneous rain protection - water runs off outside
- Numerous ventilation slots for optimal air circulation
- Stable and can only be operated from the inside
- Integrated mosquito net

Precisely fitting ventilation grilles for the Carbest sliding windows 31590/31591 for VW T5/T6. The ventilation insert is simply inserted into the window frame and then locked in place. A completely circumferential rubber piping ensures a perfect seal of the window. Attractive design in matt black.

Airvent left, suitable for Carbest sliding window 31590 (left side)
 461600 132,28

Airventright, suitable for Carbest sliding window 31591 (right side)
 461601 132,28



Frame colour:
 Silver grey



Aluminium
 high roof pop-up window

- Real glass pane in sturdy outer frame
- Ideal for alcove vehicles, very good ventilation
- Wall thicknesses from 30-35 mm - Cut-out size 460 x 160 mm

Replacement sash for window 34432 34433 189,-

Porthole acrylic glass -
 RW NAUTIC Ø 295 mm

- High-quality, powder-coated aluminium frame
- Tinted, double acrylic glass
- Fastening by gluing
- For wall thickness 40mm



Rigid version (cannot be opened and ventilated) Easy installation, durable and reliable. Cut-out dimension: Ø 295 mm, complete dimension: Ø 320 mm

32263 101,90

ROOF LIGHTS



Without Fan

Weight: 2.1 kg

from 68,90

In the colors
White and Crystal

VENT 28 with hood

- Fresh air for the bathroom and kitchen of your motorhome
- Ideal for small rooms
- Aerodynamically shaped outer dome for more contact pressure
- High quality, shockproof and UV-resistant
- Permanent ventilation

Technical data: Cut-out dimension: 28x28 cm, outer dimension: 35x34,5 cm, roof thickness: 2,5-5 cm, height above roof 9 cm, dimensions of inner frame: 32x32 cm. Assembly according to the sandwich principle: no drilling on the roof, inner frame is screwed directly to outer frame.

White	36033	68,90
Crystal (slightly translucent)	36038	82,10

DOMETIC



from 165,--

Mini Heki STYLE 40 x 40 cm Small roof hatch - great light incidence

- Can be opened in 3 positions: fully open, half open, bad weather position
- Double acrylic glazing
- Aerodynamically shaped glass dome
- With blackout blind and fly screen
- Suitable for roof thicknesses of 25 to 42 mm or 43 to 60 mm
- With handle
- For motorhomes and caravans
- Fits perfectly into a standard opening

Conveniently sets up the dome using just one **adjustment bracket**, 3 **grid positions**: Fully open, fan position and bad weather position. Maximum opening angle: approx. 50°

Mounting: Clamping principle, outer frame is put on and sealed. The inner frame is simply clipped into place.

Technical data

Cut-out dimension: 400 x 400 mm, outer dimension: 520x535 mm
Opening angle: 50°, weight: 3.3 kg, colour: cream white

With forced ventilation

for roof thickness 25-42mm	38080	165,-
Pallet with 40 pieces	380801	on request
for roof thickness 43-60mm	38081	165,-
Replacement glass with forced ventilation	380891	89,90

For the installation of the HEKI's you need approx

1 cartridge butyl sealant, white	38062	13,44
Gasket for glass MINI HEKI, rm	38063	6,90

Recommended top speed 130 km/h, depending on vehicle body and installation position. We recommend the installation of a spoiler (art. no .36044 or 36047)

HIGH-QUALITY ROOF BONNETS IN A NEW DESIGN



CARBEST
INNOVATIONS FOR MOBILE LIFE

- In 2 sizes: 70x50 or 45x40 cm
- Double glazed dome surface
- Integrated blackout system
- Integrated insect screen
- Built-in LEDs
- Maximum opening up to 60
- Easy operation with gas springs
- For roof thicknesses of 25-60 mm
- Roof hood height 90 mm

① Panorama roof hood 70x50 cm

Cut-out dimension: 702x502 mm

Total dimension: 818x617 mm

Without forced ventilation, with LED

31878 418,90

With forced ventilation, with LED

318780 444,-

② Roof hood 45x40 cm

Cut-out dimension: 452x402 mm

Overall dimension: 577x577 mm

Without forced ventilation, with LED

31877 279,90

With forced ventilation, with LED

318770 295,91

① 70x50 cm

② 45x40 cm



Integrated insect screen and blackout system in the inner frame.

4 integrated LED lights in the inner frame with ON/OFF switch.

MaxxFan Deluxe Roof Hood with Raincover

- Ventilation when outer hood is open
- Roof ventilator with closed outer hood
- Protection against rain even when open
- Patented, shock-resistant and UV-resistant outer hood
- Temperature selection by electronic thermostat
- Remote control or manual control in case of power failure
- 3 colours available
- Can be supplemented with a blackout blind (with or without LED lighting)

Equipment: 12 V ball bearing motor, 2 opening levers, mosquito net, remote control, manual control

MaxxFan Deluxe clear glass	398192	429,99
MaxxFan Deluxe White	39819	429,99
MaxxFan Deluxe Smoke	398191	429,99

Blackout blind for MaxxFan Deluxe roof hood Without LED lighting

398193 71,69

With LED lighting (not shown) 398194 98,12

MaxxFan Deluxe Clear Glass

MaxxFan Deluxe White





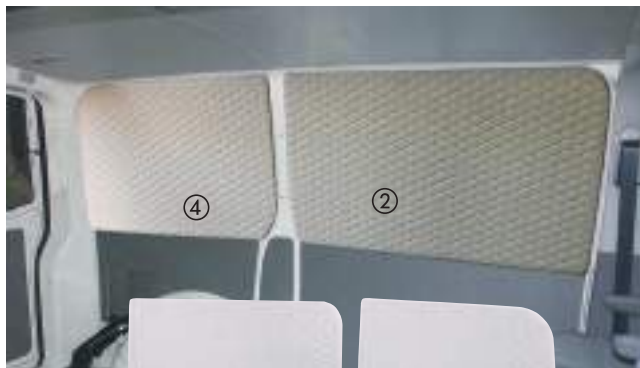

CARBEST
INNOVATIONS FOR MOBILE LIFE

Quilted interior trim for VW T5/T6/T6.1 buses without windows

- Cosy ambience in VW T6 without windows
- Chic imitation leather look with quilting
- Fixing material included in delivery

Easy to attach with dowels in the existing holes in VW T5/T6 (without glazing) or with Velcro. Incl. fixing material. The material is colour-coordinated with the VW interior colours.

① 1x panel for sliding door	32000	139,-
② 1x panels for side opposite sliding door	32001	144,-
③ 1x panel for rear right side window	32002	139,-
④ 1x panel for rear left side window	32003	139,-

FITTING:

Imitation leather, grained, for other interior trim (e.g. spars)

Light grey, laminated with 3 mm foam	510211	41,90
Light grey, unlaminated	510211-1	30,50



Volkswagen window bags

- Large storage volume with 2 interior compartments
- Easy installation without tools and modification to the vehicle
- Blackout function
- Robust, easy-care and odourless imitation leather.

Window bag with handle for VW T5/T6/T6.1 California Ocean, Coast and Beach from year 2003, rear right side window

1 net and 1 closed outside pocket for phone, glasses etc.

Dimensions: approx. 80 x 46,5 x 12 cm **919169** **89,90**

Window pocket systems



- ① **Window panels** For darkening and holding the window pockets
All VW T5/T6/T6.1 KR station wagons without comfort trim and California Beach/Multivan Startline KR up to 2009
- | | | | | | |
|------|----------------|--------------|-------|----------------|--------------|
| Left | 9191680 | 64,99 | Right | 9191681 | 64,99 |
|------|----------------|--------------|-------|----------------|--------------|
- (VW T5/6 LR in preparation)

Mercedes Vito "long" without Comfort trim, glazed

Left	9191684	64,99	Right	9191685	64,99
------	----------------	--------------	-------	----------------	--------------

Renault Traffic KR and identical vehicles such as Opel Vivaro, Nissan NV 300, Fiat Talento) glazed, without comfort paneling

Left	9191686	64,99	Right	9191687	64,99
------	----------------	--------------	-------	----------------	--------------



Window pockets To be attached to the sturdy window panels by means of Velcro. The pockets for the window panels can be combined very well:

② large bag 28 x 48 x 9 cm	919162	49,90
③ medium bag, 45 x 26 x 6 cm	919161	39,90
④ small bag, 36 x 20 x 5 cm	919160	24,89



ACCESSORIES

FOR MINICAMPERS AND CAMPING BUSES

- CONTENTS -

VENTILATION GRILLE/WIND DEFLECTOR	222-223
MOSQUITO NETS/DARKENING OF DRIVER'S CAB.....	224-227
INSULATION/WEATHER PROTECTION	228-229
ACCESSORIES FOR MULTIVAN/CALIFORNIA BEACH	230-231
ACCESSORIES FOR CALIFORNIA OCEAN/BEACH	232-233
ACCESSORIES FOR CITROEN SPACETOURER	234-235
WATER SYSTEMS/SETS COOKING & COOLING	236-237
COMPRESSOR COOLERS	238-239
SOLAR SYSTEMS/SOLAR ACCESSORIES.....	240-243
BATTERIES AND CHARGING TECHNOLOGY	244-247
INVERTERS	248-249
PARKING HEATERS	250-251
GAS DETECTORS/ALARM SYSTEMS	252-253
LIGHTS	254-257
GUTTER HIGHRAIL/MULTIRAIL	260-261
SUN SAILS/TAIL TENTS/APRON TENTS	262-269
AWNINGS	270-277
BICYCLE CARRIER	278-279
CAMPING FURNITURE/HOUSEHOLD/ORGANIZER	280-284
DRIVE-ON WEDGES/COMFORT	285-287
HOLIDAY TRAVEL COLLECTION	288-292
VW COLLECTION	293

VENTILATION GRILLE / WIND DEFLECTOR

Wind deflector

- Ventilation even in the rain, water runs off outside
- Aerodynamic shape
- No whistling when the window is open
- Transparent, slightly grey tinted
- TÜV approved / with KBA test number
- One set for driver and passenger door
- Mounting without drilling
- Also fits power windows



VW T5/T6 year 03 onwards	36405	64,95
VW T4 from My.90	36421	59,-
VW T3 year 80 - 89	36420	59,-
VW T2 year 70 - 78	36404	47,60



Ford Transit from 01/07	36427	66,95
Ford Transit from 2014	36428	66,95
Ford Transit Custom, My. from 2013	364271	67,95



Exclusive

- Burglar-proof ventilation for the cab doors
- Optically high-quality execution
- Colour: anthracite
- Set of 2, driver and passenger side



Standard

VW Transporter

VW T5/T6 from 2004		
Standard	461629	102,49
Exclusive	461630	118,21



VW T4 1990-2003	46145	97,34
VW LT 1996-2006	46155	80,98
VW T2/T3 1980-1989	46144	78,28
VW Caddy 2004-2020	46208	123,21
VW Amarok per pair	462066	81,93



VW T5/T6



VW T4



Ventilation grille

- Fresh air in the living room,
- Effective aeration and deaeration
- Stable and burglar-proof
- Quick to install, locks into the sliding window
- With mosquito net
- Rain protection - Water runs off the outside

① AIRvent - Ventilation grille for sliding window VW T5/T6 design in exclusive structure with complete circumferential rubber piping for perfect sealing of the window

Left	461631	127,83
Right	461632	133,28

② AIRvent large ventilation grille for sliding window VW T4

right side	46159	127,83
Left	46160	100,86

③ AIRvent small ventilation grille for sliding window VW T4

right side	46161	50,58
Left	46162	60,56

④ AIRvent ventilation grille for sliding window VW Caddy My. 2004 - 2020 standard: top surface smooth black sheet metal

right side	46087	104,82
Left	460871	107,41

Ventilation grille for living area

(not shown)

Fiat Scudo

Right	461891	117,81
Left	46189	117,81

Opel Movano B

Left	461972	70,77
------	--------	-------

VENTILATION GRILLE / WIND DEFLECTOR



Wind deflector			
Mercedes Sprinter	until year 06	36417	74,51
Mercedes Sprinter, VW Crafter	from year 04/06	36416	74,51



MB Sprinter	until 2006, per pair	46153	78,28
	from 2007 on, per pair	46149	78,28
VW Crafter	from year 2007, per pair	46155	80,98



Ventilation grille			
Ford Transit Custom and Tourneo Custom, with mosquito net			
from year 2013	per pair	461571	78,23
Tourneo Connect from year 01/2014 (for rear rear window)		460856	79,97



Ford Transit from year 2000			
from year 2000	per pair	46157	80,98
from year 2014	per pair	460854	79,88



Fiat Ducato, Boxer, Citroën Jumper			
With 3 ventilation slots for driver / passenger side			
My. 94 - 02	per pair	46152	78,28
My. 02 - 06	per pair	46156	78,28
from 2007	per pair	46148	77,97
from My.4/2014	per pair	461480	80,88

5 ventilation slots - 50 % more ventilation area
from Bj. 07 - 3/14 Driver. 461482 42,90



AIRvent for original sliding window.			
Fiat Ducato from 2007			
Provides air exchange and prevents the interior from overheating			
from 2007, driver.		461483	108,81
from 2007, passenger's side		461484	108,81

Ventilation grille



Fiat Ducato, Peugeot Boxer, Citroën Jumper			
Year 1994 - 2006		36402	67,95
Fiat Ducato, Peugeot Boxer, Citroën Jumper			
from 2007 onwards		36403	74,51

Wind deflector



Opel Vivaro, Renault Trafic, Nissan NV 300			
until 2014	per pair	46197	81,88
from year 2014	per pair	460852	79,88



For sliding window Opel Vivaro, Renault Trafic			
left from 2014		461973	142,43
right from 2014		461974	142,43



Renault Master, Opel Movano			
as of 2011		36432	67,95
Renault Trafic, Opel Vivaro, Nissan Primastar			
Year 2010 - 2014		36431	67,95
from 2014		36408	67,95

MOSQUITO NETS



VW Caddy sliding door



CitroënSpaceTourer



VW Caddy tailgate

Mosquito nets for VW Caddy & Citroën SpaceTourer

- Fine-meshed, flexible insect protection net
- Simple and secure fastening with elastic, magnet or Velcro tape
- No modification to the vehicle necessary
- Integrated, central door opening
- Zipper opening can be conveniently operated from the inside and outside

The nets for the sliding doors can be used on the right and left. The integrated elastic band makes attachment simple and reliable (no Velcro, no snap fastener). The net closes reliably at the bottom of the sill with a lead tape. The respective zipper doors can be opened/closed from the inside and outside. The tailgate net with 2 zippers can be rolled up and fixed. Rear doors can be closed with net. For the journey we recommend to remove the net.

For VW Caddy /Caddy Maxi up to year of construction 2020 sliding door or tailgate (with and without glazing)

Mosquito net for right or left sliding door Fastening with elastic band **46283** **159,-**

Mosquito net for tailgate Fastening **46284** **159,-**

For Citroën SpaceTourer/Jumpy and other models
Types: Peugeot Traveller/Expert, Toyota Proace Verso (all from 2016), Opel Zafira Life/Vivaro C (from 2019) with tailgate

Mosquito net for tailgate, fastening with elastic band **461333** **169,-**

Mosquito net for sliding doors, fixing with magnet **461334** **169,-**

Mosquito nets for Ford Transit



- With mounting hardware

For year 2000 - 6/2012

Sliding door **46451** **159,95**
 Rear door **46136** **150,-**

As of 7/2012

Sliding door **461404** **145,95**
 Tailgate **461405** **145,95**

REMIcare Van -

sliding insect screen door
For Ford Transit Custom V362
35069 329,95

Renault Trafic, Opel Vivaro B, Nissan NV 300



Sliding door **from 2002 to 2013** **46141** **149,95**
 Sliding door **from My.2007 to 2013** **461411** **155,95**
 Slidingdoor **from My. 2014** **461412** **149,95**
 Rear door **from 2014** **461413** **159,95**

Mosquito nets for Fiat Ducato, Peugeot Boxer, CitroënJumper from 2007 onwards

Insect screen sliding doors from REMIcare

For high door cut-out box/station wagon L2 /L4 /L5 wheel base height: 1710 x width 1250 mm

35068 327,95

For low door cut-out, short wheel-base box/station wagon L1 wheelbase height: 1435 x width: 1080 mm

35066 329,-

For lowdoor cut-out, medium wheel basepanel/station wagon L2, height: 1435 x width: 1250 mm

35067 329,-



Mosquito net for sliding door, door height: 1480mm Suitable for high roof type H1 flat roof and H2 high roof, width 1075 mm. Front entry, from 2007 **46240 161,99**

Mosquito net for rear door (not shown) Entry in the middle, Door height: 1790mm, High roof type: H2 from 2007 **464521 161,99**



Mosquito nets for rear doors

Fine mesh insect screen net with 2-way zipper allows passage from inside and outside without removing the net. It is also possible to open only the upper part of the net. Reliable attachment with Velcro tape on body panel or rubber cord around rear door seal. Sealing at the bottom by lead tape. Rear doors can be closed with net. For driving we recommend to remove the net

Fiat Ducato (fastening with Velcro tape) **461730 199,-**

MB Sprinter with standard high roof, from 2006 and VW Crafter with standard high roof from 2006 to 2016:

Sliding door right (fastening with magnet) **464524 189,-**

Rear doors (fastening with elastic band) **461736 199,-**

VW Crafter from year of construction 2017:

Sliding door right (mounting with magnet) **464523 189,-**

Rear doors (fixing with rubber band) **464502 194,-**



Fiat Ducato rear door



VW Crafter rear door



Mosquito nets for Mercedes Sprinter



Mercedes Sprinter with mounting material not suitable for standard high roof sliding door **46143 149,95**

Mercedes Sprinter NCV3 wheelbase: 3665 and 4325 mm, not suitable for standard high roof sliding door **46450 166,95** Rear door **464501 166,95**

Mosquito nets for Mercedes Vito

Mercedes Vito until 2003: sliding door **46139 149,95**
Rear door **46142 149,95**

Mercedes Vito/Viano from 2004: sliding door **46140 149,95**
Rear door **461401 129,95**

Mercedes Vito from 2014: sliding door with comfort paneling **461402 149,95**
Rear door **461403 149,95**



Mosquito net for tailgate

- Simple attachment
- With blackout curtain

The mosquito net is stretched around the tailgate seal by means of a rubber cord and lies tightly at the bottom with lead tape. A large door with two-way zipper allows passage from inside and outside without removing the net.

Mercedes Vito 461332 179,90



MOSQUITO NETS FOR VW TRANSPORTER



Mosquito net for VW T3/T4/T5/T6 and Crafter

For VW buses T3 from year of construction 1980 - 1989 without comfort panelling **46130 139,96**

For VW buses T4 up to year of construction 2003 without comfort cover For station wagon, box, Multivan Startline and California Beach **46132 144,89**

For VW buses T5/T6 from 2003 on without comfort paneling For station wagon, panel van, Multivan Startline and California Beach without side-mounted air conditioner **461351 169,90**

For VW buses with comfort trim Multivan/Caravelle T5/T6 from 2003, (not Startline until 06/2010) **461350 173,89**

For California T5/T6 from 2003 (not California Beach until 06/2010) **461353 172,90**

For VW LT up to 2006 not for standard high roof **46143 149,95**

For VW Crafter from 2007 on wheelbase: 3665 + 4325mm, not for standard high roof **46450 166,95**

REMIcare mosquito net sliding door for VW Kombi/Multivan sliding door

- All-round insect protection
- Now the sliding door is also tight
- All-round frame
- Cosy honeycomb decor
- Light and air are provided
- Perfect closure

REMIcare Van - Volkswagen T5/T6 Transporter and Transporter station wagon

Startline versions

35062 399,-

Multivan and Caravelle

35063 425,95

VW Crafter from 2006-2016

For low sliding door

with surrounding frame Height: 1650 x Width: 1360 mm

35070 349,-



Mosquito net for sliding door of VW T5/T6

Tight mosquito net gives even the smallest mosquitoes no chance. Frame adapted to the sliding door opening of the VW bus. Elegant design - perfect fit. Integrated honeycomb blind.

- Version for left-hand drive **46131 499,-**
- Version for right-hand drive **461311 499,-**



Mosquito net tailgate for VW T4/T5/T6

The mosquito net is stretched around the tailgate seal by means of a rubber cord and lies tightly at the bottom with lead tape. A large door with two-way zipper allows passage from the inside and outside. The tailgate can be closed easily, for the journey we recommend to remove the net.

VW T4 until 2003 estate and box, **46133 144,89**

VW T5/ T6 from year 03 estate, box, Multivan, California and California Beach with and without pop-up roof **46135 139,90**

Mosquito nets for tailgate VW T5/T6

- Simple attachment
- With blackout curtain

The mosquito net is stretched around the tailgate seal by means of a rubber cord and lies tightly at the bottom with lead tape

A large door with two-way zipper allows passage from inside and outside without removing the net. The blackout curtain is simply rolled up. The tailgate can be closed without any problems, for driving we recommend to remove the net.

461331 169,90



Mosquito net for windows of VW T4

Station wagon / Bus My. until 2003 for original sliding windows **46134 47,90**

DARKENING OF THE DRIVER'S CABIN

DOMETIC FP300 - Roller blind system for Fiat Ducato

- Double pleated Duette honeycomb material for maximum insulation against heat and cold
- Operation from bottom to top - optimal privacy protection
- Lightning fast installation - no need to remove existing components!
- Slim top panel - leaves room for a lift bed
- Infinitely adjustable - lets light into the vehicle or darkens the cockpit completely
- Specially designed for vehicles without rear view mirror and side airbag
- Also suitable for vehicles with rain sensor box
- Colour Beige

Windscreen FP300	37463	404,-
Side windows SP200	374395	473,-



Perfectly matched to the Fiat Ducato models X250 and X290 as well as the identically constructed Peugeot Boxer and Citroën Jumper models. Not suitable for vehicles with rear view mirror or side airbag.



ASSEMBLY? MINUTES! Neither the A-pillar nor the sun visors need to be removed.

EASY INSTALLATION Without removing the interior trim - unobstructed view of the entire exterior mirror

PERFECT CLOSURE Operation from bottom to top - optimal privacy protection

BEST SOUND QUALITY Side panels with cut-outs for the speakers in the A-pillar



VW cab darkening, pleated blind for windscreen

Heat + view protection in one. The blind is unlocked with double lock from the A-pillars and brought together at the handles to the middle. The closure takes place there via magnetic tapes. The mirror can remain at the windscreen. Mounting only possible with handles on the A-pillar!

May not be used on vehicles with AIRBAGS in the A-pillar.

For T4, My. 2003 until end of 2009	37409	269,-
For T5, My. 2010 until 07. 2015	374090	289,-



Side curtains as a set for driver's cab VW Transporter T5/T6

2-piece, for driver and passenger door, suitable for front window pleated blind, Myfrom 2003 onwards

19241	175,-
-------	-------

INSULATION / WEATHER PROTECTION



Climacover weather protection cover

Ideal protection against rain, snow, ice and dirt. With windows and ventilation openings. Mounts over the complete roof.

Climacover for VW T6.1/T6/T5 from 2003 onwards

For KR, Easy Fit roof and California, front high	37391	456,90
For LR, Easy Fit roof, front high	37394	499,-
For KR, super flat sleeping roof, front high	37393	445,90
For KR, sleeping roof SCA 194, front high	37360	445,90

NEW: Climacover for EasyFit-roof front high with high scissors from 2021

For VW T5/T6 KR/California/California Beach as of 2003	373941	449,-
For VW T5/T6/T6.1 LR	373940	439,-
For MB Vito long	373942	439,-



Sleeping roof tent bellows insulation inside

Protection from intense heat or cold. Can be opened by means of a zipper on the windows. Additional ventilation opening with zip.

Mounting: by means of Velcro straps and Velcro discs (enclosed).

Interior insulation for VW T6.1/T6/T5

For KR, super flat roof, front opening	37396	399,-
For KR, super flat roof, rear opening	37385	388,90
For KR, EasyFit SD, front opening	37398	399,-
For LR, super flat roof, rear and front opening	37397	399,-
For LR, EasyFit SD, front opening	37388	399,-
For California from 2003, California Beach 06/2010	37389	399,-

NEW: Insulation for EasyFit roof front high with high scissors from 2021 onwards

For VW T5/T6/T6.1 KR	373981	419,-
For VW T5/T6/T6.1 LR	373881	409,-
For MB Vito long	373882	399,-



Thermocover for sleeping roof Campster from Pössl

Thermocover outside for sleeping roof of CitroënCampster. Thickness 8 mm. Is fastened with velcro tape.

37461 229,-



Outdoor thermo cover

Luxurious window cover for the cab window. Also covers the side windows. Hooks onto the side doors. A viewing window is closed with Velcro and can be opened if required. Supplied with packing bag

Vehicle type no.	Year of manufacture	Price	Item
Fiat Ducato	94-02	37438	119,90
Fiat Ducato	02-06	37435	119,90
Fiat Ducato	06-14	37436	119,90
Fiat Ducato	from 15	37437	119,90
Ford Transit	07-14	37442	119,90
Ford Transit	from 15	37443	119,90
Merc. Sprinter	06-14	37444	119,90
Merc. Sprinter	from 15	37445	119,90
Ren. Master	08-10	37446	119,90
Ren. Master	10-14	37447	119,90
Ren. Master	from 15	37448	119,90
Citr. Campster	from 16	37460	119,90
VW T4	90-03	37449	119,90
VW T5	06-15	37450	119,90
VW T6/T6.1	from 15	37451	119,90

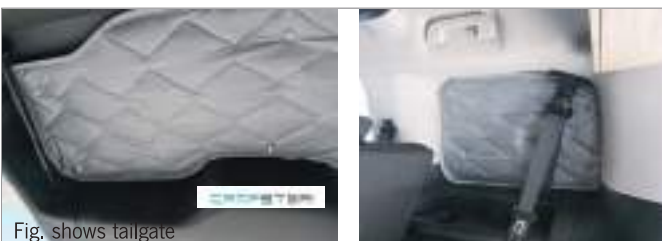

Fig. shows tailgate

Thermal mats inside for CitroënCampster from Pössl from 2017 onwards

Cab	3-piece	37346	59,99
Living area + tailgate	4-piece	37347	79,99
Complete set	7-piece set	37348	139,90



Thermal mats T5/T6/T6.1

For VW T5/T6 all models from 03
cab 3-piece from 2003

37281 59,90

For panel vans, Multivan Startline, California Beach up to 6/2010
with hard fibre panelling Living area 4-piece short wheelbase

37296 72,90

Living area 4-piece long wheelbase 37297 82,90

Tailgate 1-piece 37283 29,90

Tailgate 2-piece 37282 29,90

Caravelle, Multivan. California with comfort interior trim

Living area 4-piece short wheelbase 37311 79,90

Living area 4-piece long wheelbase 37312 82,90

Tailgate 1-piece 37306 29,90



Thermomats T4

VW T4 from year 90 Cab 3-parts 37232 49,94

VW T4 from year 90 Rear window 1-piece 37233 26,91

VW T4 - low doors from year 90 Rear wing door 2-pcs. 37234 32,90

VW T4 - KR from year 90 Living room 4-piece 37235 92,90

VW T4 - LR from year 90 Living room 4-piece 37236 92,90

VW T4 - KR from year 90 Living room air-conditioned roof 37252 72,90



Thermomats T3

VW T3 9/79 - 7/90 Driver's cab 3-parts 37230 49,99

VW T3 9/79 - 7/90 Rear window 1-piece 37231 29,99

VW T3 9/79 - 7/90 Living room 4-piece 37237 72,90



Thermal mats VW Caddy and Nissan

VW Caddy from 09 Driver's cab 3-piece 37226 62,90

VW Caddy Complete set 8 pieces 37228 140,90

VW Caddy Maxi from 09 Complete set 8 pieces 37227 139,90

For Nissan NV200 5-ply material

Driver's cab 5-piece 37320 52,90

Living area 5-piece 373201 94,90



Thermal mats Mercedes Sprinter / VW Crafter / LT

3-piece set for driver's cab, 7-layer Isoflex material for high heat insulation in summer and cold insulation in winter. Incl. suction cups

Mercedes Sprinter until 04/06 37242 52,90

Mercedes Sprinter from 05/06, VW Crafter from 07 372421 52,90

VW Crafter from 2016 372422 59,99

VW LT until 96 37238 57,91

Mercedes Vito from 2015 372693 65,90



Thermal mats

Ford Transit 86-89 Rear window 1-piece 37233 26,91

Ford Transit from 00 Driver's cab 3-pcs. 37269 52,90

Ford Transit 07-14 Driver's cab 3-pcs. 372691 52,90

Ford Custom from 15 Driver's cab 3-pcs. 372692 67,90

Renault Kangoo until 07 Complete set 8-pcs. 37229 139,90

Renault Kangoo from 08 Complete set 8 pcs. 372291 139,90

Renault Trafic, Opel Vivaro, Nissan NV300, Primastar, Fiat Talento

02-14 Driver's cab 3-pcs. 37273 59,90

from 15 3-piece driver's cab 372731 67,90



Thermal mat accessories

① **Thermomat foil Isoflex, 8-ply**
1,60 m wide, grey. Outside aluminized (sun reflection)
Price per running metre (rm) 37365 15,99

② **Edging tape 40/20**, price per
Grey 55920 0,80 Black 559207 0,80

③ **Eyelets** with washers for inserting suction cups in fabric,
Ø14 mm 90211 10,90 Ø11mm 90210 8,90

④ **Pushbuttons** to screw on 10 pcs 56230 9,90

⑤ **Suction cup Ø40 mm**, 10 pcs. SB-packed 37277 8,-

VW MULTIVAN/CALIFORNIA BEACH ACCESSORIES



The Reimo camping box!

- ① **Kitchen box for vehicles with 3-person bench** With 12-litre fresh water and 5-litre waste water system, shower head with hose, stainless steel sink, compartment for the gas cartridge cooker and storage compartment for (cooking) crockery and cutlery. As a prefabricated unit with mounted technology. Wood decor: High-gloss white/olive For VW T6/T5 Multivan, California Beach **13203 982,22**
- ② **Seat/storage box 60 litre** installation right, seat upholstery upholstered with fabric Wood finish: high-gloss white/olive **13207 825,-**
- ③ **Floor plate** required for construction of bed Decor Granitto For VW T6/T5 Multivan, California Beach **13212 309,47**

Lounger mat EVEN

- More sleeping comfort in the Multivan or California Beach
- Compensates for the different heights in the bench seat
- Consists of two chambers

Dimensions: approx. 198 x 152 x 7 cm. Packing size: Ø28x 70 cm
93075 189,-



Couch mat in the Multivan



Couch mat in the California Beach

Utensilo set for cab seats

- 2 or 3 bags with holding mat
- The bags are fastened with velcro to the holding mat
- Also suitable for California Ocean & Coast

Scope of delivery for passenger seat: holding mat, 1x bag 36 x 20 x 5 cm, 2x bags 45 x 25 x 6 cm **919165 189,-**
Scope of delivery driver seat: holding mat, 1x bag 36 x 20 x 5 cm, 1x bags 28 x 48 x 9 **919164 149,-**



NEU

Sliding door shelf

Useful shelf made of weather-resistant HPL for additional storage space next to the seat (e.g. for mobile phone, glasses, toys). Fastening by means of Velcro tape, without modification to the vehicle. The delivery is disassembled for self-assembly, effort approx. 15 min

For T5/T6 California Beach / Coast / Ocean, Multivan KR
(not Multivan Startline and Calif Beach until 6/2010)

Dimensions: L 390 x W 200 x H 370 mm **13226 199,-**

For T5/T6 Caravelle KR

Dimensions: L 490 x W 200 x H 367 mm **13229 199,-**

For station wagon, KR, with Reimo-V 3000 bench:

Without plastic trim rear right.

Dimensions: L 630 x W 210 x H 370 mm **13227 199,-**

With plastic panelling rear right

Dimensions: L 495 x W 200 x H 370 mm **13228 199,-**

9 litre compressor cooler VAN S

- Fits between driver and passenger seat
- With drink holder, interior light and ice cube tray
- Incl. carrying strap and 2 lashing points for fastening

Cooling capacity: -18°C to 10°C Dimensions W x D x H: approx. 210 x 459 x 320 mm. Weight: approx. 8,5 kg Connection: 12, 24 Volt, power consumption approx. 35 Watt **713541 419,-**





Porta Potti box with upholstered cushions

Practical storage box for the Porta Potti Qube 335. HPL laminate

High gloss white	10698	369,-
Anthracite	106981	359,-

Toilet Porta Potti Qube 335

- **Integrated WC lid lock, manual piston pump**
- **Practical vent button**

Holding tank 10 litres, flush water tank 10 litres. Dimensions: W342 x H315 x D382, seat height 308 mm. Weight 3,3 kg

660102	144,95
---------------	---------------

Window pocket for side window rear right

- **Large stowage volume with 2 interior compartments**
- **Per 1 mesh and closed outer pocket for phone, glasses etc**
- **Easy installation without tools and changes to the vehicle**
- **With carrying handle**

Robust, easy-care and odourless material
Dimensions: approx. 80 x 46,5 x 12 cm

919169	89,90
---------------	--------------



Awning Mauritius L

Water column: 2000 mm, material: 300D RipStop Polyester, steel poles

Dimensions: W 510 x D 300 cm	900573	139,-
-------------------------------------	---------------	--------------



Thermal mats for VW T6/T5

- **Heat and cold protection for your Multivan or California**

Driver's cab 3 parts VW T6/T5 from 2003 onwards **37281** **59,90**

For Multivan Startline, California Beach until 6/2010
with hardfibre cladding

living area 4-piece short wheelbase **37296** **72,90**

Living area 4-piece long wheel **37297** **82,90**

For Caravelle, Multivan, California with comfort interior panelling

Living area 4-piece short wheelbase **37311** **79,90**

Living area 4-piece long wheelbase **37312** **82,90**



Floor mats for driver's cab and side door

- **Stops dirt and water**
- **Is simply inserted in the entrance step, no additional fastening**
- **3 piece set**

Material: 100% Polypropylene, Anthracite
1 pair cab + 1x sliding door

51670	59,-
--------------	-------------

Ventilation grille T5/T6

- **Effective ventilation for the cab doors**
- **Optically high-quality execution**

e.g. for VW Multivan & California **461630** **118,21**



Insulation driver's cab for VW T5/T6

① **Complete protection** windshields and side windows, all vents and radiator grille are well packed. Lowers the temperature in summer up to 10° C below the outside temperature. Simple attachment: Elastic strap to hang on driver and passenger door **90786** **169,99**

② **Thermal mat for windscreen and side windows**
Eight-layer fold-out mat **90923** **224,90**



VW CALIFORNIA OCEAN/COAST/BEACH ACCESSORIES

Climate protection hood for sleeping roof

- Ideal protection against rain, snow, ice and dirt
- Includes window and ventilation openings

For VW California with sleeping roof **37391** **456,90**



Tent bellows insulation for sleeping roof

- Heat and cold protection for your California Ocean or Beach
- Including windows and ventilation openings
- Fastening with insertion straps

For VW T5/6 California as of 2003 and California Beach as of 6/2010 **37389** **399,-**
 For VW T4 California **37399** **399,-**



Mosquito net for sliding door

- Close-meshed net with zipper and lead tape
- Fastening with Velcro and press studs



For VW buses T4 up to 2003 without comfort trim

For Multivan Startline and California Beach **46132** **144,89**

For VW buses T5/T6 from 2003 without comfort trim

For Multivan Startline and California Beach **461351** **169,90**

For VW buses with comfort trim Multivan/Caravelle T5/T6 from 2003,

461350 **173,89**

For California T5/T6 from 2003 (not California Beach until 06/2010)

461353 **172,90**

Mosquito net rear door on p. 185

CampSleep small additional bed for driver's cab

- Comfortable additional bed with 10 cm thick mattress
- Wooden plate reinforcement on the upper body side
- Stabilization by belt from bed to handle (passenger)

Additional bed for the driver's cab, 2 foldable, weight approx. 6kg
42174 **246,-**



Wind deflector driver's door T6.1/T6/T5

- Effective ventilation for the driver's cab doors
- Optically high-quality execution

For VW California Ocean, Coast, Beach **461630** **118,21**



Stainless steel load sill protection

- Noble protection of the sensitive bumper
- Optical upgrading of the vehicle
- High fitting accuracy due to CNC milling

VW T5 from 2003 - 2015 with tailgate (also Multivan and Caravelle) **46397** **112,-**
 VW T6 with tailgate (also Multivan and Caravelle) **46398** **116,30**



Van Organizer

With 1 large and 8 smaller pockets. Fastening with press studs. Approx. dimensions: W74 x H32 cm.

Grey/blue **919233 14,99**
 Grey/Green **919232 14,99**



Storage boxes with lid

The boxes are foldable with fixing brackets and lids to lock in place. With 4 wheels. Material: TPR/PP.

Large S: capacity 30 litres, dimensions: L 54.5 x W 40 x H9.6/27.5 cm, colour: grey with lime **940292 19,99**

Large M: Capacity 45 litres, Dimensions: L 61 x W 45 x H 10/30.4 cm Colour: Grey with Petrol **940293 24,99**

Large L: capacity 65 litres, dimensions: L 72 x W 53 x H 10/31 cm Colour: White with grey **940294 29,99**



Floor mat for VW T6/T5 cab

- Very high quality material
- Edges edged

Material: 620 g/sqm, TPO coating, black
 4 fastenings

515821 159,-



Floor mats for driver's cab and side door

- Stops dirt and water
- Is simply inserted in the entrance step, no additional fastening
- 3 piece set

Material: 100% Polypropylene, Anthracite
 1 pair cab + 1x side door

51670 59,-



5-piece aluminium pot set

- Made of high quality aluminium with foldable handles
- Can be stacked inside each other to save space

Set consists of:

1 pot with lid Ø approx. 17cm
 1 pot with lid Ø approx. 19cm
 1 pan Ø approx. 19cm



92303 59,99



9 litre compressor cooler VAN S

- Fits between driver and passenger seat
- With drink holder, interior light and ice cube tray
- Incl. carrying strap and 2 lashing points for fastening





Cooling capacity: -18°C to 10°C Dimensions W x D x H: approx. 210 x 459 x 320 mm. Weight: approx. 8,5 kg Connection: 12, 24 Volt, power consumption approx. 35 Watt

713541 419,-



CITROËN SPACETOURER ACCESSORIES

also for Pössl Campster, Pössl Vanster, Peugeot Traveller, Toyota Proace Verso, Opel Zafira D Life.

Grey Anthracite

Floor mats for Citroën Campster from Pössl
Mats for the footwell under the dashboard, entrance or boot. Material: synthetic fibre 1900 g/m² in grey and anthracite, each with black stripes

Cab		
Grey	51686	39,95
Anthracite	51687	39,95
Cab entrance (2 pieces)		
Grey	51688	14,99
Anthracite	51689	14,99
Living room without rails		
Grey	51690	39,95
Anthracite	51691	39,95
Living room with rails		
Grey	51692	49,99
Anthracite	51693	49,99
Trunk without rails		
Grey	51694	34,99
Anthracite	51695	34,99
Trunk with rails		
Grey	51696	44,99
Anthracite	51697	44,99



Fig. shows tailgate



Thermal mats inside for Citroën Campster from Pössl from 2017 onwards

Driver's cab 3-piece	37346	59,99
Living space + tailgate 4-piece	37347	79,99
Complete set 7-piece set	37348	139,90

NEW: Thermal mats inside for Citroën Vanster from Pössl >2017

Driver's cab 3-piece	372811	59,99
Living room + rear window 5-piece	372812	79,99
Complete set 8-piece set	372813	139,90

Outdoor thermal cover (not shown)

Citr. Campster from year 16	37460	119,90
NEW: Citr. Vanster	37467	119,99



Thermocover for sleeping roof Campster from Pössl

Thermocover outside for sleeping roof of Citroën Campster. Thickness 8 mm. Is fastened with velcro tape.

	37461	229,-
--	--------------	--------------

Multirail

for Citroen Spacetourer/Jumpy, Peugeot Traveller/Expert, Toyota Proace, all from 3/2016; Opel Vivaro C/Zafira Life from autumn 2019 and Pössl Campster/Campi.

- Rain gutter for sun awning and roof rack
- Easy attachment of awning and awning with clamping rod or pull-in keder
- Easy mounting of the self-adhesive spoiler profiles
- The aluminium rail is already pre-drilled
- Absorption of roof loads up to 100 kg
- For keder thickness 7-8.5 mm

The Multirail is attached to the vehicle with a special adhesive (Sikaflex 252i, see left side). **The matching spoiler set with screws and assembly instructions must be ordered separately.**

Body length M (4,95 m)

Multirail right side (passenger side)	90178	279,-
Multirail left (driver's side)	901780	279,-



Multirail

Front spoiler



Rear end

Image similar

CITROËN SPACETOURER ACCESSORIES

also for Pössl Campster, Pössl Vanster, Peugeot Traveller, Toyota Proace Verso, Opel Zafira D Life.

Vertic Traffic - rear tent without poles

Also suitable for Citroen Spacetourer, Jumpy, Campster, Peugeot Traveller, Expert, Toyota Proace, all from Bj. 2015 and Opel Vivaro C, Opel Zafira Life from autumn 2019.

- Rear tent with doors in both side walls
- With window in the roof as a skylight

Inconspicuous rear awning as the base area does not protrude over the Vehicle contour. Simply pull the rear tent over the open tailgate and fasten it to the ground. Colour: grey.

Scope of delivery: tent skin, storage bag

93797 159,-

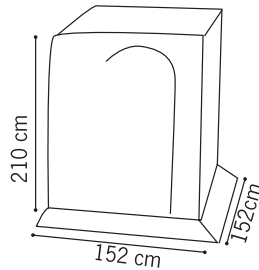
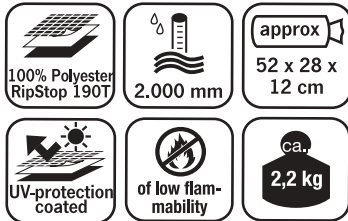

Trapez Traffic - Rear tent without poles

- Both side walls and rear wall with door
- Tinted windows with inner cover
- Mosquito net window
- With window in the roof as a skylight

With extra large interior, for camp bed, bicycles or similar. Simply pull the rear tent over the open tailgate and fasten it to the ground. The rear wall with mosquito net window can also be used as a sun sail.

Scope of delivery: Tent skin, storage bag included

93796 189,-

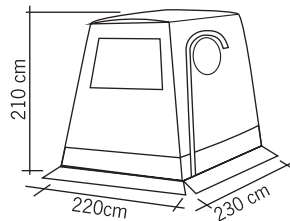
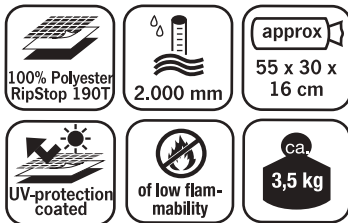

Privacy screen/shower curtain for van tailgate

- Shower without getting the rear wet
- Suitable for almost all panel vans (details at www.reimo.com)

The privacy screen can be used with or without a rear awning (no tight seal). Simply fasten it over the tailgate with the adjustable strap and fix it to the bumper with plastic hooks if required. Water column 2,000 mm, dimensions: 153 x 186cm, colour grey

936287 29,90



For Citroen SpaceTourer/Jumpy and baugl. Types

Peugeot Traveller/Expert, Toyota Proace Verso (all from 2016), Opel Zafira Life/Vivaro C (from 2019) with tailgate

Mosquito net for tailgate,
fastening with elastic band

461333 169,-

Mosquito net for sliding doors,
fastening with magnet

461334 169,-



Canister water system with 19 l canister and waste water boy - complete set

1 x 19 litre canister (60013), waste water boy (60021), submersible pump 12 l, water tap (63002), fresh and waste water hose, small parts and 12 V connection.

60000 109,-



Kitchen part compact with 2 x 12 l canisters and sink

Dimensions 37 x 37 cm

2 x 12 litre canisters (60028), submersible pump 12 l, water tap (63000), sink 37 x 37 cm stainless steel (70120), fresh and waste water hose, small parts and 12 V connection

60007 299,-



Kitchen part Cityvan with 2 x 13 l canisters and sink

2 x 13 litre canisters (60011), submersible pump 15 l, water tap (63000), sink 325 x 176 mm stainless steel (70122), fresh hose and waste water hose, small parts and 12 V connection.

60004 209,-



Hygiene set as a set - cleaning, disinfection, descaling

It contains the disinfectant cleaner DEXDA® CLEAN and KXpress descaler, as well as one or two silver pads for fresh water preservation. Suitable for motorhomes, caravans and boats. The cleaners can be used together to save time and effort. The silver pad effectively protects the fresh water from germs.

HYGIENE set	up to 80 l tank size	613013	44,90
HYGIENE set	up to 160 l tank size	613012	69,90



Town water connection from CARYSAN

- Can be mounted anywhere on the caravan or motorhome
- No reinforcement on the wall necessary
- No sawn out edges to be seen in the interior
- Flap is lockable

Scope of delivery
Template, 4 stainless steel screws, inner retaining frame. Cut-out dimensions: 135 x 99 mm for a wall thickness of 16 to 40 mm (Not for supply centre)

65208 89,90

Lightweight complete set for indoor and outdoor

With lightweight plastic basin, Submersible pump (62070), watertap LONDON chrome/white, fresh and waste water hose with screw connection DIN 96, small parts and 12 V connection with plug. Water canisters for fresh and waste water are not included. All canisters with DIN 96 fit.

60099 112,95



12V



CAMPING BUS SETS COOKING & COOLING



Camping bus set 40 E

Dometic stove 2 flame 460 x 335 mm Height 80 mm. With ignition fuse, but without piezo ignition, power 3.2 kW, gas consumption 233 g/h, 30 mbar, weight 4 kg.

Dometic sink 410 x 335 mm, height 124 mm stainless steel, drain type A included. Installation dimension W 400 x D 325 mm, weight 4 kg

Carbest 40 litre built-in refrigerator With 34 l refrigerator compartment and 6 l freezer compartment. Cooling capacity: refrigerator 0-10°C, freezer compartment max. -12°C. Dimensions: WxHxD 380 x 510 (+30 mm feet) x 508 mm. Weight: approx. 15 kg **70551 1189,90**



REIMO SET PRICE 1059,--

Camping bus set 40 K

Can cooker-sink combination with 2 cookers Sinkright. Piezo ignition. Cutout on sink for faucet (faucet not included). "Smoke" glass cover. Dimensions: W 716 x D 340 x H 100 and 50 mm. Power: 1 x A (Auxiliary), 1 x SR (Semi rapid) .Sink dimensions: W 298 x D 238 x H 150 mm

Carbest 40 litre built-in refrigerator With 34 l refrigerator compartment and 6 l freezer compartment. Cooling capacity: refrigerator 0-10°C, freezer compartment max. -12°C. Dimensions: WxHxD 380 x 510 (+30 mm feet) x 508 mm. Weight: approx. 15 kg **70552 1059,-**



REIMO SET PRICE 1079,--

Camping bus set 50 KC

Can cooker-sink combination, 2 flame 2 flame cooker-sink combination with glass cover. Piezo ignition. Power: 1 x A (Auxiliary), 1 x SR (Semi rapid). Cut-out on sink for water tap (water tap not included). "Smoke" glass cover. Dimensions W765x D355 x H50/100mm

Carbest 50 litre built-in refrigerator CV50L - 12V /24 V With 42 l refrigerator compartment and 4.5 l freezer compartment. Cooling capacity: refrigerator 5-15°C, freezer compartment max. -18°C. Dimensions: WxHxD 380 x 530 x 490 mm. Weight: approx. 17 kg **70553 1079,-**



REIMO SET PRICE 1249,--

Camping bus set 50 KD

Dometic cooker-sink combination with 2-piece glass cover Sink right, stainless steel, 2 flames, with ignition fuse. Hole Ø 39 mm for water tap (water tap not included), power 1 x 1 kW, 1 x 1.8 kW ,gas consumption 204 g/h, 30 mbar, installation dimension W 742 x D 283 mm ,external dimension W 760 x D 325 x H 179 mm,weight 6 kg.

Carbest 50 litre built-in refrigerator CV50L - 12V /24 V With 42 l refrigerator compartment and 4.5 l freezer compartment. Cooling capacity: refrigerator 5-15°C, freezer compartment max. -18°C. Dimensions: WxHxD 380 x 530 x 490 mm. Weight: approx. 17 kg **70554 1249,-**



12V

CARBEST
INNOVATIONS FOR MOBILE LIFE

Undercabinet exhaust hood stainless steel

Stainless steel housing, with lighting 2 x 1.5 W LED (2 x 80 lumen), warm white (3000 Kelvin), equipped with 2 exhaust fans. Suction capacity 98^{m3}, 12 V. Dimensions W 40 x D 27 x H 5 cm
Weight 1.8 kg. Only intended for mobile homes and caravans

31852 275,90



Integrated LED spots



Switch light & fan



Twin exhaust fan



9
LITERS



i From now on the 230V connection cable is available separately.

For VW T5 / T6

12V
24V
230V

9 litre compressor cooler VAN S

- Fits between driver's seat and passenger seat VW T5/T6
- With cup holder, interior light and ice cube tray
- Incl. carrying strap and 2 lashing points for fastening

Ø Power consumption: 35 watts .Connection: 12, 24 and 230 V, temperature range: +10°C to -18°C, dimensions: W x D x H 210 x 459 x 320 mm

Weight: approx. 8.5 kg.

713541

419,-

220-240 V adapter cable

Allows the cooler to be operated with 230V voltage

713540

29,90



16
LITERS



i From now on the 230V connection cable is available separately.

For Fiat Ducato

12V
24V
230V

16 litre compressor cooler VAN M

- Fits between driver's seat and passenger seat Fiat Ducato
- With interior light & ice cube tray
- Carrying strap included

Ø Power consumption: 40 watts . Ø Powerconsumption: approx. 0.35 - 0.53 kwh, connection: 12, 24 and 230 V .Temperature range: +10°C to -18°C ,dimensions: W x D x H approx. 230 x 532 x 384 mm, weight: approx. 10 kg,

713542

459,-

220-240 V adapter cable

Allows the cooler to be operated with 230V voltage

713540

29,90



PowerCooler compressor coolers - The high-quality all-rounders

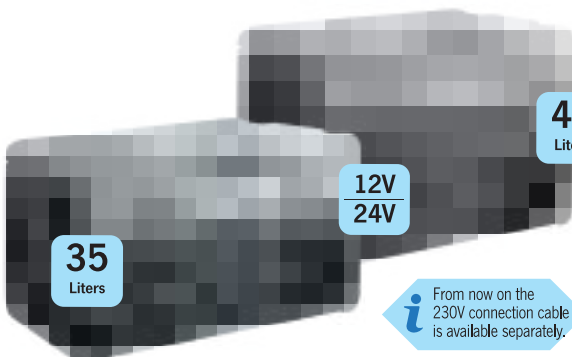

35
Liters

12V
24V

45
Liters

i From now on the 230V connection cable is available separately.



- Cooling capacity -18°C to +10°C
- Robust housing with sturdy Carrying handles
- Integrated lashing eyes for fastening of a carrying strap
- Electric thermostat with digital temperature display
- Three-stage battery protection to protect the vehicle battery
- Color: Black/Grey

Product	PowerCooler 35	PowerCooler 45
Useful capacity (litres)	Refrigerator/freezer 4.5 L/30.5 L	Refrigerator/freezer 7.0 L/38 L
Supply voltage	12/24 Volt DC	
Ø Power consumption	12V: 55W, 4,6A / 24V: 55W, 2,3A	12V: 65W, 5,4A / 24V: 65W, 2,7A
Temperature range	+10 °C to -18 °C	
Noise emission	45 dB	
Dimensions (LxWxH) mm	650 x 400 x 395	650 x 400 x 465
Weight approx.	17,1 kg	18,5 kg
Item number	714102	714103
Price	419,-	489,-



100-240V AC adapter cable allows the coolers to be operated with 230V voltage

714101

29,90

CampCooler - The new compressor cooler series for camping, outdoor and leisure

NEW
2022

- Cooling and freezing from -20°C to +10°C
- Robustly constructed with reinforced handles and base corners
- Digital control panel and LED interior lighting
- Integrated battery protection

The new powerful compressor coolers from Carbest offer a cooling capacity down to -20°C. The temperature is set via a digital control unit and can be selected between the MAX or ECO power settings. The removable basket insert in the main compartment allows for easy cleaning. The 12/24V connection cable is included, the 100-240V AC adapter cable is available separately



Model	35 liters	45 liters	55 liters
Useful capacity (litres)	35 L	45 L	55 L
Temperature range	+10 °C to -20 °C		
Supply voltage	12/24 Volt DC		
Ø Current consumption	12V: 5,0A / 24V: 2,5A		
Noise emission	< 45 dB		
Dimensions (LxWxH) mm	690x345x382	690x345x462	690x345x524
Weight (approx.)	12,1 kg	12,9 kg	13,8 kg
Item number	71456	71457	71458
Price	379,-	429,-	499,-

100-240V AC adapter cable, enables operation of the coolers with 230V voltage

	714499	19,90
--	--------	-------



50 L refrigerator in noble optics

- Powerful, low-noise compressor
- Operation via LED display
- Particularly economical LED interior lighting
- Installation frame available separately

The temperature can be regulated via an LED display, which is flush-mounted in the inner wall of the refrigerator. Integrated LED lighting in the interior. Door hinged on the right (cannot be moved)

Ø Power consumption: 40 watts
 Temperature range refrigerator: +5°C to +15°C
 Temperature range freezer compartment: max. -18°C
 Volume total/refrigerator/freezer: 46,5/42/4,5 L
 Dimensions: W 380 x D 490 x H 530 mm
 Weight: approx. 17 kg **713572** **679,-**



MOBILE SOLAR SYSTEMS

Powerful, foldable solar modules for on the road

①

120 W



NEW
2022



②

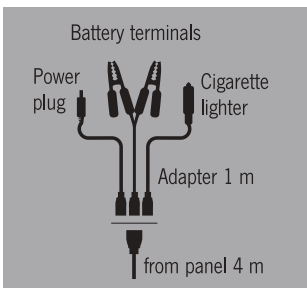

① Foldable solar panel with 120 Watt and charge controller

- 36 powerful Sunpower cells
- Built-in charge controller with additional USB output
- 4 m connection cable with 3 adapters for different connection options
- Folds into a bag

With USB charging output 5 V/1.2 A in the charge controller. Includes 3 connection adapters with crocodile clips, plug for cigarette lighter socket and 12 V power supply plug (e.g. for EFOY GO). Adapter cables can be stowed in the attached pocket. Dimensions when open: 1462 x 560 x 4 mm. Folded dimensions: 440 x 560 x 20 mm. Weight: approx. 2.3 kg. 120 W panel, rated voltage 20.88 V/rated current 5.97 A

82506 329,-

② **Connection cable 50 cm** For direct connection of the Carbest Folding Panel to the Carbest Energy Station 813740 (page 14). Cable length 50 cm, 1x solar connector (only suitable for Carbest Folding Panel 82506 or Solar Case 825030), 1x 50 A high current battery connector

850921 29,90

③

120 W



③ Solar case 120 Watt

- Mobile charging of your 12 V battery
- Monocrystalline cells
- 10 A charge controller integrated
- 3 adapter cables with 1 m length each
- Charge controller incl. USB connection (for charging mobile phones & co.)
- Foldable feet
- Incl. robust hard case



Rated voltage/rated current	19.1 V/6.28 A
Efficiency	20,4%
USB port	5 V/1.2 A
Connection cable	4 + 1 m
Dimensions open in mm	1010x690x30
Dimensions closed in mm	505 x 690 x 60
Weight	12 kg
Art. No.	825030
Price	269,-

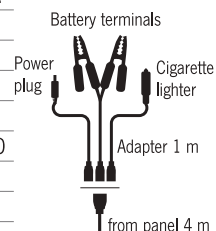

NEW
2022

④ **Connection cable 50 cm** For direct connection of the Carbest Folding Panel to the Carbest Energy Station 813740 (page 14). Cable length 50 cm, 1x solar connector (only suitable for Carbest Folding Panel 82506 or Solar Case 825030), 1x 50 A high current battery connector **850921 29,90**

⑤ 50 W



⑤ Foldable solar panel with 50 W power

Easy and small to stow away and can be used anywhere. With 9 solar cells. Includes eyelets at the corners for quick attachment. Integrated bag. Weight: approx. 2.5 kg. Dimensions: 960 x 680 x 8 mm. Folded: 220 x 320 x 60 mm **82501 169,-**
Connecting cable for linking up to 3 panels **82504 11,50**

ULTRA-FLEXIBLE SOLAR MODULES

Solar complete sets with ultra-flexible high-performance solar modules

- Sets include solar panel with pre-installed 8m cable, high quality MPPT charge controller, roof feed through
- Power from 80 to 160 Watt

Complete set Power Panel Flex 80 white Optimal for silent consumers and for low energy demand, e.g. for mobile phone charging and other USB devices such as battery packs or cameras, light and water pump, battery maintenance and compensation of silent consumers

Complete set Power Panel Flex 110-130 white or black Set with the Carbest 130 W solar module. For example for light, water pump, compressor cooler, occasionally heating

Complete set Power Panel Flex 150/160 white or black Set with the Carbest 150/160 W solar module. e.g. E.g. for light, pump, TV/Sat, heating and compressor fridge

All sets included for gel, AGM, acid or LiFePO4 batteries (battery type adjustable).

Mounting Notice:

All flex modules must be fully glued (without air pockets). Subsequently, all module edges must be completely sealed up to the top cover layer.

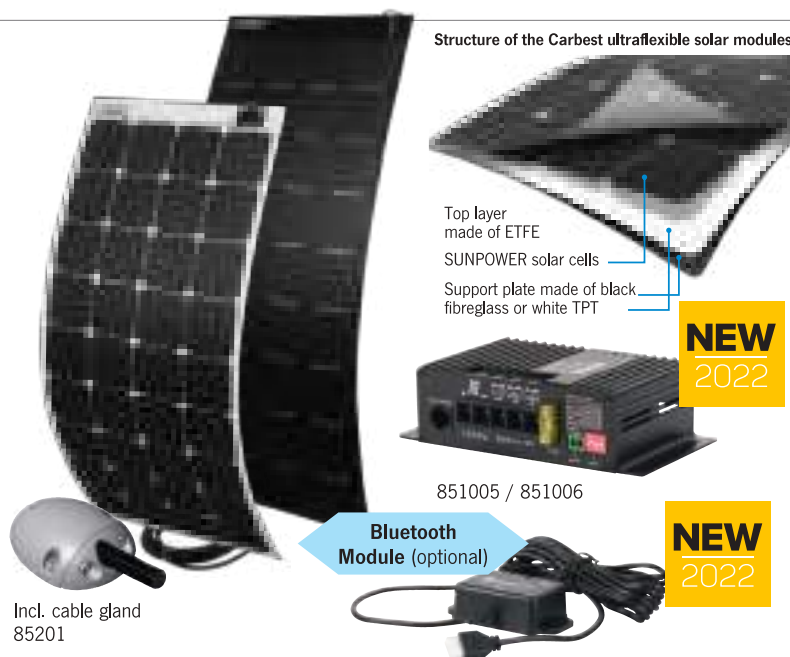

	Complete set Power Panel Flex 80 white	Complete set Power Panel Flex 110 Pro black	Complete set Power Panel Flex 110 white	Complete set Power Panel Flex 125 Square black	Complete set Power Panel Flex 130 Square white	Complete set Power Panel Flex 150 Pro black	Complete set Power Panel Flex 160 white (rear connection box)
Solar module power	80 W	110 W	110 W	125 W	130 W	150 W	160 W
Solar module	1 x 85319	1 x 853172	1 x 853170	1 x 853173	1 x 851563	1x 85329	1x 85333
Cable (2 x 2.5 mm ²)	8 m preinstalled	8 m preinstalled	8 m preinstalled	8 m preinstalled	8 m preinstalled	8m preinstalled	8m preinstalled
MPPT solar charge controller	851005	851005	851005	851005	851005	851005	851006
Controller power	165 W	165 W	165 W	165 W	165 W	165 W	350 W
Cable gland	85201	85201	85201	85201	85201	85201	85201
Item no.	85270	85271	85272	85273	85274	85275	85276
Price	299,-	379,-	369,-	439,-	419,-	549,-	529,-

Ultra-flexible high-performance solar modules from 80 to 150 watts

- Sunpower cells: Significant increase in power output even at a less than optimal angle to the sun
- Only 3 mm thin! Enables bending radii of up to 20°
- Approx. 5 x lighter than conventional modules
- Can be walked on when glued over a wide area
- Compact connection (size approx. 90x75mm, height approx. 22mm) with pre-installed 6/8 m cable (2x 2.5 mm²)
- High-quality ETFE surface
- Ideal also for maritime use

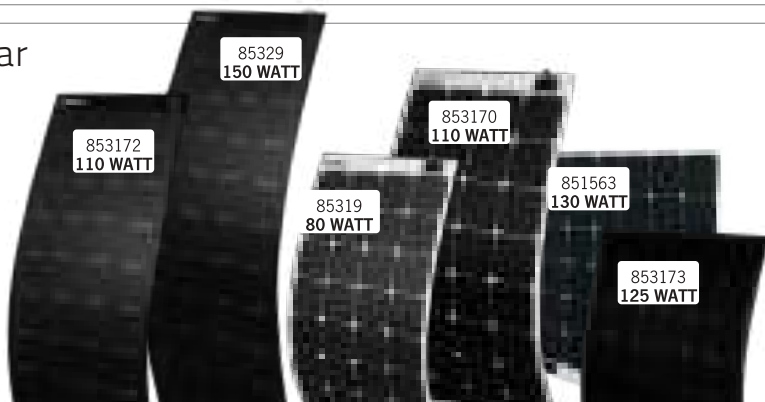

	Power Panel Flex 80 white*	Power Panel Flex 110 Pro black	Power Panel Flex 110 white	Power Panel Flex 125 Square black	Power Panel Flex 130 Square white*	Power Panel Flex 150 Pro black*
Power / Number of cells	80 W/56 cells	110 W/32 cells	110 W/32 cells	125 W/36 cells	130 W/36 cells	150 W/44 cells
Material top layer	ETFE	ETFE	ETFE	ETFE	ETFE	ETFE
Material carrier plate	TPT	Fiberglass	TPT	Fiberglass	TPT	Fiberglass
Efficiency	20,8 %	22,5 %	22,6 %	22,5 %	23,7 %	23,7 %
Short circuit current (Isc)	2,8 A	6,88 A	6,32 A	6,94 A	6,37 A	6,32A
Open circuit voltage Voc)	36.5 Volt	22.77 Volt	21.9 Volt	23.36 Volt	25.42 Volt	30.1 Volt
Rated voltage (Vmp)	30.8 Volt	17.6 Volt	18.6 Volt	19.8 Volt	21.6 Volt	24 volts
Rated current (Imp)	2,6 A	6,25 A	5,97 A	6,31 A	6,01 A	5,97 A
Dimensions mm LxWxH (Box H)	1000 x 550 x 3 (22)	1100 x 540 x 2,5 (22)	1125x540x3 (22)	840x800x2,5 (22)	860 x 800 x 3 (22)	1470 x 540 x 3 (22)
Cable (2 x 2.5 mm ²)	8 m	6 m	8 m	6 m	8 m	8 m
Weight incl. cable	approx. 2,1 kg	approx. 4,0 kg	approx. 3,2 kg	approx. 4,3 kg	approx. 3,9 kg	approx. 5,6 kg
Art. No.	85319	853172	853170	853173	851563	85329
Price	229,-	309,-	289,-	349,-	337,-	469,-

SOLAR MODULES WITH ALUMINIUM FRAME

Full-Black or Aluminium-Silver Solar Complete Sets from 100 to 140 Watt



	Complete set 100W All-Black	Complete set 120W Full-Black	Complete set 140W Full-Black	Starter complete set CB-100B (without MPPT solar charge controller)	Complete set CB-100	Complete set CB-100 Slim	Complete set CB-120	Complete set CB-140
Solar module power	1x 100 W	1x 120 W	1x 140 W	1x 100 W	1x 100 W	1x 100 W	1x 120 W	1x 140 W
Solar module	1x 85229	1x 85239	1x 85240	1x 85226	1x 85226	1x 85285	1x 85227	1x 85250
Charge controller	851005	851005	851005	85135	851005	851005	851005	851005
Controller power	243 W	243 W	243 W	180 W	165 W	165 W	165 W	165 W
Cable (2x 2,5mm ²)	10 m	10 m	10 m	10 m	10 m	10 m	10 m	10 m
Cable gland	850493	850493	850493	85049	85049	85049	85049	85049
Mounting spoiler	850909	850909	850909	850906	850906	850900	850906	850906
Art. No.	840313	840314	840312	851061	851071	851072	851073	851074
Price	279,-	329,-	329,-	239,-	259,-	289,-	289,-	319,-



HIGH PERFORMANCE SOLAR MODULES WITH ALUMINIUM FRAME FROM 100 TO 140 WATT FROM 100 TO 140 WATT

- Solid aluminium frame (CB series: Silver / Full Black series: Black coated)
- Monocrystalline cells
- Tempered glass
- Protected connection with 1m cable (2x 2.5 mm²)
- Power: 100 to 140 Watt
- 25 years performance guarantee (After 25 years still 80% performance)

	CB-100	CB-100 Slim (slim Design)	100W Full-Black	CB-120	120W Full-Black	CB-140	140W Full-Black
Power / Number of cells	100 W/36 cells	100 W/36 cells	100 W/36 cells	120 W/36 cells	120 W/36 cells	140 W/36 cells	140 W/36 cells
Efficiency	20,2%	18,5%	20,7%	20,2%	20,7%	20,2%	20,7%
Short circuit current (Isc)	5,83 A	5,66 A	5,85 A	6,6 A	6,63 A	7,75 A	7,77 A
Open circuit voltage (Voc)	22.82 Volt	22.74 Volt	22.8 Volt	23.51 Volt	23.47 Volt	23.3 Volt	23.28 Volt
Rated voltage (Vmp)	18.35 Volt	18.94 Volt	18.32 Volt	19.43 Volt	19.39 Volt	19.26 Volt	19,21 Volt
Rated current (Imp)	5,45 A	5,28 A	5,46 A	6,18 A	6,19 A	7,27 A	7,29 A
Dimensions in mm LxWxH	1200x545x35	1580x410x35	1200x545x35	1400x545x35	1400x545x35	1640x545x35	1640x545x35
Weight	approx. 7,5 kg	approx. 7,5 kg	approx. 7,5 kg	approx. 9.0 kg	approx. 9.0 kg	approx. 10,5 kg	approx. 10,5 kg
Art. No.	85226	85285	85229	85227	85239	85250	85240
Price	179,-	189,-	199,-	219,-	229,-	239,-	259,-



REIMO BEST PRICE 34,90

Solar charge controller 12V/24V - 15 A. Optical capacity display. Reliable and inexpensive charge controller for solar systems up to 360 watts charging power.

85135 34,90



MPP 165 Duo Digital
12 V, charging programs for all battery types, also LiFePO4, 10-30% higher charging current, connection for solar computer, solar module output 40-165 Wp, max. solar module voltage 50 V, charging current max. 12 A. Dimensions: W 131 x D 77 x H 40 mm, weight 190 g.

851307 102,99



NEW 2022

Bluetooth-enabled MPPT charge controller, data display via app or separate monitor

- Improved version: from now on, the fuse is accessible from the outside
- Bluetooth function only in conjunction with Bluetooth module 851007 (Free app for Android and iOS)
- Battery type adjustable: GEL, lead-acid, AGM, LiFePO4 batteries
- Two battery outputs
- Max. Input voltage is 50V

① Charge controller 12V/12A/max. 165W	851005	69,90
① Charge controller 12V/25A/max. 350W	851006	99,90
② Bluetooth module with 3m cable	851007	34,90
③ Separate solar monitor, consisting of mounting frame and 5m cable with connector.	851003	59,90
Temperature sensor with 3m cable (not shown)	851004	6,90

SCANSTRUT
CANALOCK TECHNOLOGIES

Professional roof ducts

- Extremely high-quality maritime designs (sea-water-resistant)
- Can be used as wall or roof culvert
- Protection class IP 68 (waterproof, dustproof)
- Also without perforation for individual self-drilling



	Width Ø in mm	Opening max. Ø in mm	Height mm	Cable Ø in mm	Material	Item no.	Price
① DS16	39	16	19,0	2 - 8	Black box	85257	22,90
② DS-H10	43	10	28	6 - 10	Black box	85258	44,90

CARBEST
INNOVATIONS FOR MOBILE LIFE



Inexpensive cable bushings

For safe cable routing through roofs or walls. Small, compact, watertight. For gluing on with Sikaflex incl. PG 13.5 cable gland for cables Ø 6-12 mm.

① White, single (L12,0 x D6,5 x H3,8cm)	85049	10,90
② Black, 1-fold (L12,0 x D6,5 x H3,8cm)	850493	10,90
③ White, 2-fold (L12,4 x D9,3 x H3,8cm)	850491	12,90
④ Black, 2-fold (L12,4 x D9,3 x H3,8cm)	850494	12,90



CARBEST
INNOVATIONS FOR MOBILE LIFE

Stable aluminium spoiler profile

- 2-part, can be shortened as required
- Fastening by gluing and / or screwing
- Suitable for Carbest solar modules
- Scope of delivery: extruded profile, plastic caps, installation instructions

Aluminium profile bars 550 mm 2 pieces (suitable for Carbest modules 85226, 85227, 85229, 85239, 85240, 85250)

Colour white	850906	49,90
Colour black	850909	49,90

Aluminium profile bar 410 mm 2 pieces (suitable for Carbest module 85285)

Colour white	850900	44,90
--------------	--------	-------



BÜTTNER ELEKTRONIK
SOLAR SYSTEMS

MT bonding set for solar systems

Contains everything needed to fix the MT mounting profiles to the solar module and to glue the profiles: MT Cleaner 205, MT Primer 210, Sikaflex 252 i, stainless steel screws, accessories, instructions.

MT bonding set I for 1 module* 85074 59,90
MT Bonding Set II for 2 modules* 850741 64,90

Bonding of aluminium possible without primer



MS adhesive with high tack
DEKAsyl MS-5 Polymer
Adhesive with high adhesion and high initial strength for structural bonding of brackets, side skirts, frames and wheel covers, climate boxes, solar or SAT systems. Due to the high strength, fixing times can be reduced.

290 ml

Black, 290 ml	500304	21,71
	GP* 74,86 / 1 liter	
White, 290 ml	500305	21,71
	GP* 74,86 / 1 Liter	



Lithium Iron Phosphate Batteries (LiFePO4) The batteries have high capacity and load tolerance and require no maintenance. They are also up to 60% lighter than gel batteries, charge 3-10 times faster and offer smaller footprints than standard batteries. The integrated battery management system BMS protects the battery from excessive charging currents or voltages, protects it from harmful operating temperatures, provides data on the state of charge and balances the individual cells. **For more information on the individual products on this page,**

please visit www.reimo.com

CARBEST
INNOVATIONS FOR MOBILE LIFE

Lithium iron phosphate batteries (LiFePO4) with battery management

- Super-compact, very durable!
- Battery protection through integrated battery management
- Reliable and powerful battery technology for tough continuous use!
- Up to 90% current drain (short term)
- 3 times less weight - therefore more payload
- 5-10 times longer life (approx. 2000-5000 cycles)
- 3-10 times faster charging
- Battery with M8 thread connection

Carbest LiFePO4 Batterieserie

Leichte, kompakte und sichere Lithiumbatterien mit integriertem Batteriemangement. Ideal für Freizeit, Hobby, Wohnmobil und Caravan. Ladung mit AGM- oder besser Lithium-Ladegeräten.

Type	Volt (V)	Ah*	Length mm	Width mm	Height mm	Weight kg	Art.no.	Price
① 60	12	60	195	165	180	7,2	81208	549,-
② 100	12	100	305	170	210	13	81209	949,-
③ 150	12	150	485	170	240	18	81238	1499,-
Bluetooth batteries								
④ 100BT	12	100	330	170	195	12	81413	1199,-
⑤ 100BT	12	100	305	170	210	13,5	81410	999,-

*Power available at 90%



Lithium battery with Bluetooth technology

- Battery and charge status can be called up at any time via smartphone or tablet
- Free app for smartphone & tablet available online

AGM Green-Power - The proven batteries for motorhomes

EXCLUSIVE

12V

- Powerful solar and residential batteries
- In use for 5 years with very good experience
- Installation in the living space according to EC regulations possible
- Absolutely maintenance-free and environmentally friendly, also ideal for solar heating
- High cycle stability,
- 24 months warranty
- Shipping possible, as no dangerous



Type	Ah2 (100 h)	Ah3 (20 h)	Length mm	Width mm	Height ¹ mm	Weight kg	Art.no.	Price
GP 60	65	60	250	160	200	19,0	850519	199,90
GP 80	90	80	350	165	205	24,8	85051	239,-
GP 80S	90	80	265	165	245	23,4	850511	239,-
GP 90	100	90	306	169	225	26,0	850521	249,-
GP 100	110	100	328	172	230	29,4	850512	259,-
GP 100 T54	110	100	335	170	190	29,0	850518	299,-

¹ Height with screws, without battery terminals (+ approx. 25mm height with terminal), ² C100 (value at 100-hour discharge), ³ C20 (value at 20-hour discharge), ⁴ 850518 suitable for Volkswagen Transporter generation 5 and 6 under driver's seat/passenger seat (battery installed laterally)

Carbest Deep-Cycle AGM batteries

EXCLUSIVE

from **199,-**



- Absolutely maintenance-free and environmentally friendly
- Installation independent of position
- High cycle stability, also ideal for solar systems
- 24 months warranty (on production defects)
- Shipping possible, as no dangerous



Type	Volt (V)	Ah* (100 h)	Ah** (20 h)	Length mm	Width mm	Height mm	kg	Art.no.	Price
80 PL	12	90	80	350	167	179	22,5	850529	199,-
100 T5	12	110	100	353	175	190	26,3	850530	239,-
100 PL	12	110	100	330	171	220	29,0	850531	229,-

*C100 (Value at 100 hours discharge) **C20 (Value at 20 hours discharge)

BATTERY MANAGEMENT / LITHIUM BATTERIES



CARBEST
INNOVATIONS FOR MOBILE LIFE

Carbest battery monitor 24 Volt

Increases battery life, disconnects loads automatically when voltage drops below 21V. Connects automatically when 24 V is reached again. Overload/short circuit and reverse polarity protected. With switch, 2 control LEDs. Aluminium housing
24 V (21-32 V) 60 A max. dimensions: 15 x 7 x 5 cm, weight: 0.4 kg

82179 29,90



Bluetooth Battery Monitor

- Battery level on smartphone read
- For Android or IOS
- Small design
- Connection to plus and minus pole of the battery

The small device is connected with the approx. 50 cm long cable to the battery terminals with 6.3 mm ring lugs and protected by a 1 A fuse. Then just load the app.

Dimensions: 60.2 x 44.7 x 14.9 mm, weight: 50 g.
81245 42,80

LPS: Lithium battery, charge booster, sine wave inverter and 230V charger all in one

Technical data

Capacity.....[Ah] 100
Cycle stability [Ah].....2000
Protection class.....IP21
Dimensions [mm].L390 x W244 x H250
Weight [kg].....28
12 VDC output
Continuous power [A].....50
230V/50Hz Output
Continuous power [Wrms]....1300
< 15 minutes [Wrms].....1500
Peak [Wrms].....3000
Operating times [hrs : min]
200 W @ 230 V.....4:30
500 W @ 230 V.....1:45
1000 W @ 230 V.....0:50

Charging times [hrs : min]

50 A (mains/alternator).....1:45
Charger 12 VDC IN50A
Charging by the alternator via the starter battery. Connect 12 VDC IN to the starter battery and the built-in charging current distributor ensures that the starter battery is charged first and the vehicle electrical system is protected
Display panel
With overview of consumption status and remaining operating time as well as charging status and remaining charging time.

LPS 81354 2679,-
Remote control for LPS 813545 122,-



Remote control

- Incl. sine wave professional inverter 1500W
- Fixed installation and portable operation possible
- Charging (230V) at the socket possible
- Charging with built-in 50A booster via alternator or solar possible

EZA: Lithium battery, charge booster, battery manager, solar controller and battery monitor

- Available as 80Ah and 130Ah
- Ultra fast charge in less than 2 hours, by connecting to the alternator and built-in charge booster. 25 A charge in just 15 minutes.
- High level of safety thanks to integrated battery charge management. It protects against overvoltage, undervoltage and reverse polarity
- Fixed installation of the system in the vehicle
- Several units can be connected in parallel to increase capacity (optional)
- App-capable! (Control with mobile devices, e.g. smartphone via Bluetooth)

With integrated 400 Watt solar controller for solar panels, can also be used for wind generators. Charging via alternator, solar and 230V with additional charger possible. With battery monitor (included). This informs in detail about the battery condition (A, Ah, %, V). Dimensions battery monitor: Ø front plate 64mm, Ø body 52mm, installation depth: 79mm.

5 connections are available: **red** - for starter battery - **yellow** - for solar panels - **black** - for residential consumers (input/output) - **blue** - charging input - For an additional charger, such as a generator, or a fuel cell - **grey** - inverter output - For an external inverter 230 Volt consumers EZA80 Special Euro 6 - 12 Volt TTC: Capacity of 80 A/h. Integrated 400 Watt MPPT solar controller. With battery monitor. Installation possible in the seat base of VW T5/T6.



EZA80 180 mm x 300 mm
EZA130 203 mm x 268 mm

EZA80, weight 17 kg, dimensions: H:180 x W:300 x D:260 mm
EZA130, weight 25 kg. Dimensions: H:203 x W:268 x D:360 mm

813491 2715,50
813481 3590,-

BOOSTER

Charge converter, booster, solar regulator and charger - All in One



- With integrated solar regulator and 230 V charger for electronically controlled power charging of the living area battery
- Up to 30 Ah charging power in driving mode
- Three different charging sources possible (12 V, 230 V, solar)
- Five-stage charging process thanks to desulphating function
- Super compact, ideal for intelligent alternators
- Euro 6 ready

PWS GOLD 30-M* suitable for gel, AGM and lead/acid batteries. For alternator output: from 90 A, charging output from alternator: 30 A, max. solar regulator output: max. 250 watts, dimensions (L x W x H) in mm: 228 x 135 x 98, approx. weight: 1.7 kg **800824** **413,-**



Charging booster, optimal charging while driving



- For acid, gel and AGM batteries
- Additionally with special charging programs for modern lithium LiFePO4 batteries
- Especially suitable and recommended for vehicles with EURO6 standard
- Optimises battery charging and compensates for power loss

Powerful charge converter with microprocessor-controlled IUoU characteristic for optimum charging of the battery while driving. Compensates for voltage losses with long cable runs and/or small cross-sections. Suitable for acid, gel and AGM batteries as well as state-of-the-art lithium LiFePO4 batteries. Supplied with temperature sensor.

VCC 1212-30 - 30 A charging capacity **831801** **179,-**

Charging booster for motorhomes

- Charging characteristics for lead-acid, lead-gel, AGM and lithium batteries
- Temperature compensated charging with optional temperature sensor
- Charging current typ. 25 A, short term 30 A
- Charging voltage up to 14.7V (with temperature sensor up to 15.1 V) depends on battery type
- Charging characteristic IU0U



25 A Booster WA 121525 for motorhomes

The Booster WA121525 is used for optimum charging of 6-cell 12 V lead-acid, lead-gel AGM and lithium batteries in motorhomes while driving, regardless of the alternator voltage. The booster WA121525 is a clocked up/down converter that compensates for the fluctuating alternator voltage and provides a high charging current. **Technical data:** Average charging current 25 A, dimensions: 130 x 90 x 47 mm

800243 **135,-**

Thermosensor for battery monitoring

E6741 **18,99**



CARBEST
INNOVATIONS FOR MOBILE LIFE

Reliable professional chargers with 10 A or 20 A

3-step charging, battery type selectable, suitable for gel, AGM, lead acid and lithium batteries. Input voltage: 180-240 V AC, output voltage: Max. 14.6 V DC. Incl. connection cable and battery clamps.

Charger 10 A, weight approx. 1.4 kg
Dimensions: 130 x 150 x 50 mm **80280** **79,90**

Charger 20 A, weight approx. 2.0kg
Dimensions: 160 x 150 x 70 mm **80281** **99,90**



CARBEST
INNOVATIONS FOR MOBILE LIFE



Intelligent charger for all battery types

- LCD display
- Diagnostic and revive function
- For all 6/12V batteries (AGM, Gel, Wet)
- Microprocessor, 5 step charging program
- Controlled trickle charge
- Ideal for winter break

Microprocessor controlled Carbest charger with 4.0 Amp charging power. Technical data: Protection class IP65, battery capacity: max. 120 Ah. Input voltage: 220-240 V AC/ 50 Hz, max. 70 W. Output voltage: max. 14.7 V DC/4.0 A. Dimensions: (LxWxH) 18 x 8 x 5 cm. Weight: 0.5 kg **819010** **35,99**

CARBEST
INNOVATIONS FOR MOBILE LIFE

from **119,-**

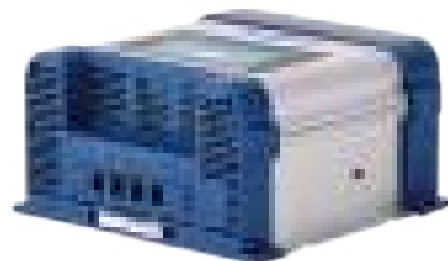

Intelligent battery charger with the latest 7-step charging technology

- Especially for charging lead-acid batteries in dual-battery systems
- Automatic 7-stage charging algorithm delivers a much faster, more efficient and complete charge, without voltage drops
- For charging GEL / AGM / WET batteries
- This intelligent battery charger can be used as a constant power supply for accessories that require a stable and clean DC voltage

Product	Dimensions mm	Art.no.	Price
10 A	226 x 175 x 95	80283	119,-
15 A	226 x 175 x 95	80284	179,-
20 A	226 x 175 x 95	80285	199,-

NDS

Charger with regeneration function

- For acid, gel and AGM batteries
- With switchable desulphation function

LED charging phase indicator. For batteries with a loss of power, the sulphation function can be switched on and the sulphate layer broken up by means of pulse charging. This increases the usable capacity of the battery again. Partially sulphated batteries can thus be considerably regenerated in their performance. However, fully sulphated defective batteries will not be able to be regenerated. Dimensions: (L x D x H) 270 x 165 x 120 mm

80086 **403,-**



SINE WAVE / SINE WAVE INVERTER

CARBEST
INNOVATIONS FOR MOBILE LIFE

200
WATT



400
WATT



600
WATT



E13

Type	① Power Inverter 200 W	② Power Inverter 400 W	③ Power Inverter 600 W
Input voltage DC	12 V	12 V	12 V
Input voltage range	10,5 V-16V	10,5 V-16V	10,5 V-16V
Nominal power	200 W	400 W	600 W
Peak power short time(2S)	400 W	800 W	1200 W
Output voltage (±5%)	220 - 240 V	220 - 240 V	220 - 240 V
Switch-off threshold/undervoltage	10.0±0,5 V	10.0±0,5 V	10.0±0,5 V
Quiescent current	<0,17 A	<0,21 A	<0,3 A
Efficiency	>90%	>90%	>90%
Cooling	Fan	Fan	Fan
Fuse	yes	yes	yes
Connection for remote control	no	no	no
USB 5 V ~ 2.1 A	yes	yes	yes
Socket	1	1	1
Dimensions (W x H x D) in mm	120 x 100 x 50	120 x 100 x 50	150 x 100 x 50
Weight	approx. 0,6 kg	approx. 0,7 kg	approx. 1 kg
Art. No.	82291	82292	82293
Price	40,-	44,90	74,90

230 Volt devices
operate on 12 Volt
with sinusoidal voltage

- Use of many common household appliances
- USB connection 5 V ~ 2.1 A
- Battery protection through undervoltage/overvoltage shutdown
- Reverse polarity protection, overload protection
- Overtemperature shutdown (> 75°C)
- CE and e-mark* certified for installation in vehicles

*approved for installation in vehicles

300
WATT



700
WATT



1500
WATT



E8

1000
WATT

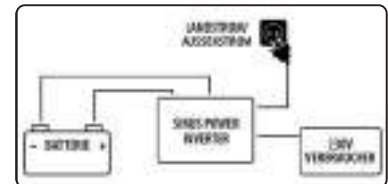

Pure sine wave voltage
for sensitive 230 V devices

Figure	①	②	③	④
Type	PS300U	PS700U	PS1000U	PS1500U
Input voltage DC	12 V	12 V	12 V	12 V
Output voltage (±5%)	230 V	230 V	230 V	230 V
Continuous output	300 W	700 W	1.000 W	1.500 W
Nominal power	300 W	700 W	1.000 W	1.500 W
Peak power shortz.	600 W	2.100 W	3.000 W	4.500 W
Shutdown threshold/under-voltage.	10.0±0,5 V	10.0±0,5 V	10.0±0,5 V	10.0±0,5 V
Quiescent current	≤0,6 A	≤0,3 A	≤0,4 A	≤0,5 A
Efficiency	≥90%	≥90%	≥90%	≥90%
Remote control connection	yes	yes	yes	yes
USB port/ampere	yes/2.1A	yes/2.1 A	yes/2.1 A	yes/2.1 A
Sockets	1	1	1	2 (1x Schuko, 1x Universal)*
Connection cable included	53cm, 4mm ²	2 m, 16 mm ²	2 m, 25 mm ²	2 m, 50 mm ²
Dimension (LxWxH) mm	260x150x60	255x186x90	317x186x90	320x152x105
Weight	1,6 kg	2,4 kg	3,0 kg	4,7 kg
Art. No.	82281	82285	82282	82286
Price	119,-	209,-	349,-	529,-

- Extremely high starting current, up to 3 times the power output
- Convert 12 volt battery current to 230 volt
- No restriction in operation, suitable for measuring computer or microwave oven
- Switch-mode technology: Almost noiseless - Lightweight & compact
- Battery protection by undervoltage shutdown
- Overtemperature shutdown (approx. 60° C)
- Reverse polarity protection, overload protection
- Approval for installation in vehicles (e-mark & CE certified)
- Incl. 12 V connection cable, 2 m (except PS300U)

Automatic load detection - The inverter switches to an energy-saving mode if no power is drawn for one minute .

Fan - When the temperature is too high, the built-in **temperature controlled fan** will automatically turn on for cooling .

Aluminium housing - Suitable for floor & wall mounting

CARBEST
INNOVATIONS FOR MOBILE LIFE

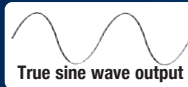

12 V

230V

INTEGRATED
ADVANCED-
SWITCHING

INCL.
CONNECTION-
CABLE

CE
E8

Sine wave inverter
with integrated mains
priority circuit

for sensitive 230 V devices



Watch video



Tested with Nespresso® capsule machine

①
**1000
WATT**

②
**1500
WATT**

④
**2000
WATT**

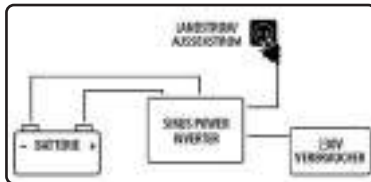

- Conversion of 12 volts to 230 volts pure sinusoidal voltage
- Very high starting current
- Battery protection through undervoltage cut-off
- Reverse polarity protection, overload protection
- Temperature-controlled ventilator, fully automatic switch-on
- Aluminium housing, lightweight yet sturdy
- 2 m connection cable
- Approval for installation in vehicles
- With USB connection + cable remote control

Integrated 230 volt mains priority circuit:

As soon as 230 volt shore power (e.g. from the campsite) is available, inverter operation is automatically interrupted. Inverter operation resumes immediately as soon as no more outside power is available.

Built-in 3-stage battery charger for gel and AGM batteries with 10 A or 15 A (depending on model).

Type	① Sine Power Inverter 1000 W	② Sine Power Inverter 1500 W	③ Sine Power Inverter 2000 W
Input voltage DC	12 V	12 V	12 V
Output voltage (±5%)	230 V	230 V	230 V
Continuous output	1000 W	1500 W	2000 W
Nominal power	1000 W	1500 W	2000 W
Peak power shortz.	2000 W	3000 W	4000 W
Shutdown threshold/undervoltage.	10.5±0.5 V	DC 10.5±0.5 V	DC 10.5±0.5 V
Quiescent current	≤0,45 A	≤0,75 A	≤0,75 A
Efficiency	>90%	>90%	>90%
Switchover time 230 V to 12 V (approx.)	≤ 8 ms	≤ 10 ms	≤ 10 ms
Remote control connection	no	no	no
Socket	1x Schuko, 1x Universal*		
Connection cable included	2 m, 25 mm ²	2 m, 50 mm ²	2 m, 50 mm ²
Battery charger (Gel/AGM)	10 A	15 A	15 A
Dimension LxWxHin mm (approx.)	330 x 230 x 100 mm	400 x 230 x 110 mm	400 x 230 x 110 mm
Weight	approx. 3,6 kg	approx. 5,3 kg	approx. 5,7 kg
Art. No.	82277	82278	82279
Price	389,-	569,-	675,-

SinePower DSP-C Inverter/Charger

- Combination of sine wave inverter and automatic charger
- Clean 230 V output voltage - for sensitive devices
- Smart standby mode - saves energy when the device is not needed



DOMETIC

The Dometic SinePower DSP-C offer maximum independence from the power supply. The intelligent combination of inverter and automatic charger monitors the mains power input and reacts to any situation: either as a supplement to the external power supply or - if required - to charge the vehicle battery. If the external power supply fails completely, the inverter switches on immediately and supplies connected devices with a pure, sinusoidal 230 V AC voltage

A maximum power of up to 2000 W ensures smooth operation of coffee machines, microwave ovens and much more

Type	DSP 1212C	DSP 2012C
Continuous power (W) / Peak power (W)	1200 / 2400	2000 / 4000
Dimensions (W x H x D mm)	284 x 118 x 405	284 x 118 x 481
Max. Charging current (A)	50	100
No-load / wide-range current consumption (A)	3,0 / <0,3	4,0 / <0,3
Connection (V)	12 (10,5-16)	12 (10,5-16)
Item no.	82988	82989
Price	1545,-	1899,-

PETROL/DIESEL HEATERS



from 1009,--



Installation by a specialist workshop is recommended



Control element
Rotary control



Control element
MultiControl

Please note that the standard installation kits do not include parts for warm air distribution

Air Top 2000 STC air heaters, compact for small vehicles

- 2 kW heater with ceramic technology for high efficiency
- Low noise level
- Heating power infinitely variable from 0.9 to 2.0 kW
- Suitable for continuous operation

Technical data: Fuel consumption 0.12 - 0.24 l/h. Rated power consumption 9 - 22 W

Weight incl. dosing pump 2,6 kg.

Dimensions approx. L: 311 x W:120 x H: 121 mm

Air Top 2000 STC-D RV Comfort complete set for diesel engines

Scope of delivery RV Comfort: Comfort package with extended installation kit Standard (parts exhaust gas routing, fuel line, electrical kit, pump, silencer and height adjustment up to 2200 m) for installation inside or outside the vehicle. Includes Multicontrol operating element

48089 1604,--

Air Top 2000 STC-D base for diesel engines 480897 1009,--

Air Top 2000 STC-B base for gasoline engines 480892 1212,--

Scope of delivery base: Heater and metering pump

An installation kit and a control element are still required

The base sets are without height adjustment and without silencer.

Control elements for basic sets (mandatory for basic sets)

MultiControl with timer 480894 102,99

Rotary control 480895 61,90

Installation kits for basic sets (mandatory for basic sets)

Standard (universal set) 480893 204,--

VW T5 / VW T6 with auxiliary heater E1911 272,90

For T5/T6 without auxiliary heater, an additional tank removal set is required

Tank extraction set 90 E1912 35,--



Alpine Kit for altitudes up to 2790 m - Plug and Play

- Applicable for the current version IV of the heaters from Brano as well as for the previous version III (this applies to the versions WIND and BREEZE, generation III and generation IV)
- Control start: approx. 1.400 m [850 hPa(mbar) | 15/EC (288K)]
- End of regulation: approx. 8.000 m [356 hPa(mbar)]
- Consumption: 9,6-12W
- Maintenance free
- The system has been successfully tested at an altitude of 2,790 m (on Europe's highest passable road).

Altitude kit 48013 374,90



VanHeat

Powerful 12 V diesel parking heaters
VanHeat 2.0-DH and
VanHeat 4.0-DH

NEW
2022



- Powerful with 2 kW or 4 kW heating capacity
- Integrated altitude adjustment up to 5,000 m (Alpine kit)
- Control via digital operating panel
- Radio remote control optionally available
- Compact design and robust housing
- Type approval according to UN ECE R122
- Approval by the Federal Motor Transport Authority according to UN ECE R10

The compact parking heaters from Carbest provide cosy warmth in your vehicle by burning diesel fuel. The control takes place via a digital control element. Installation material is included in the scope of delivery (see pictures scope of delivery).

The altitude adjustment (alpine kit) is already integrated in the housing and thus also allows a smooth operation in the high mountains up to 5,000 m.

The parking heater with a heating capacity of 2 kW is ideally suited for vans, camping buses and smaller motorhomes. The parking heater with a heat output of 4 kW is ideally suited for larger camping buses and motorhomes. Both parking heaters have a type approval according to UN ECE R122. Both heaters have approval from the Federal Motor Transport Authority.



- DIESEL
- 12 VOLT
- LCD CONTROL UNIT
- INTEGRATED MOUNTAIN KIT UP TO 5,000 m
- APPROVED
- E1 E13 CE



VanHeat 2.0-DH VanHeat 4.0-DH

Heating type	① VanHeat 2.0-DH	② VanHeat 4.0-DH
Heating cable	2000 W	4000 W
Rated voltage	12 Volt DC	12 Volt DC
Ø Power consumption (approx.)	10 - 29 W	8 - 34 W
Fuel	Diesel	Diesel
Fuel consumption (approx.)	0.12 - 0.24 l/h	0.11 - 0.51 l/h
Dimensions (LxWxH)	315x120x121 mm	380x140x150 mm
Weight heater (approx.)	2,6 kg	4,5 kg
Item number	48182	48183
Price	649,-	699,-

Optional accessories:

- ③ Radio remote control for Carbest parking heaters
Range up to 1,000 m . 48014 279,-
- ④ GSM module 48186 Price on request
- ⑤ Temperature sensor 48187 Price on request
- ⑥ Mounting bracket for VW T5/T6/T6.1
481821 Price on request
- ⑦ underfloor installation box 481822 Price on request



GAS DETECTOR



RELIABLE GAS DETECTORS

GasCube - Gas detector in noble design, now in a new improved version

- Warns of propane/butane gas (LPG) and narcotic gases
- Visual and audible indication of operational readiness, the calibration phase and the alarm
- Blue light = ready for operation / red light = alarm!

Fixed connection to 12 V on-board power supply. Pressure switch. Ready for operation after approx. 3 minutes. With highly sensitive sensor and 80 dB loud siren. Temperature-controlled sensor, which also works reliably above 25°C. Power consumption in standby: 100 mA, power consumption in alarm: 180 mA. Mounting: approx. 100 cm above the ground. Dimensions: 55,6 x 86,7 x 24 mm.

① GasCube Colour: matt white **802482 64,90**

② **NEW: GasCubeTwin** Equipment identical to above mentioned GasCube, but with connection possibilities for two optional additional sensors. These detect the gas concentration in the air just as effectively as the main sensor and provide additional safety in case of rising and falling gases. Cable length is 2.7 m.

There are 3 possible combinations of the additional sensors

1.2x sensor for detection of CO gas (carbon monoxide)

2.2x sensor for detection of LPG gas/narcotic gas

3.1x sensor CO gas + 1x sensor LPG gas/narcotic gas

GasCubeTwin Colour: Matt anthracite **802483 69,90**

③ Additional sensor CO gas (carbon monoxide) **802484 29,90**

④ Additional sensor propane/butane gas (LPG) **802485 29,90**



Feel safe, in any situation -
CNA Gas Detector

EXCLUSIVE

Gas detector GAS3/
Professional

- 2 sensors measure liquid gas, narcotic gas and carbon monoxide
- Two alarm levels
- Gas detector can also be used individually

For propane/butane gas, already below 10% of the minimum explosive gas concentration, carbon monoxide (CO) and anaesthetic gases.

47455 239,-



Gas detector GAS/
SOPOR



- 1 sensor designed for anesthetic gas, also measures presence of liquid gas
- Gas detector can also be used individually

For anaesthetic gases and LPG, already below 10% of the minimum explosive gas concentration. Mounting position: LPG 10-30 cm from the floor, anaesthetic gas next to the bed.

474551 129,-

Gas detector GAS/GPL



- 1 sensor designed for liquid gas, measures also presence of anesthetic gas
- Gas detector can also be used individually

For LPG already below 10% of the minimum explosive gas concentration and Narcotic gases. Mounting position: LPG 10-30 cm from the floor. Anaesthetic gas next to the bed.

474553 129,-

CAN bus alarm system Protect-ON Camper 849

- Digital CAN bus alarm system (2.4 GHz) for Fiat Ducato 5 + 6 with 1x radio contact for window or door and 1x radio remote control
- Expandable up to 24 radio contacts and 4 radio remote controls
- Activation/deactivation via original FIAT ignition key or via optional radio remote control

Protect-ON Camper 849 S

cope of delivery: alarm system, 1x radio magnetic contact switch for window or door, 1x radio remote control, installation material incl. wiring, 2x warning stickers for window pane, instructions

47452 259,-

Accessories:

HPS 55 Volumetr. sensor	47449	54,89
Carbest radio remote control	474481	58,91
Carbest radio magnetic contact	474472	58,80
GPS module for vehicle location (not shown)	472161	379,-
GPS antenna (without picture)	472162	61,30



CARBEST
INNOVATIONS FOR MOBILE LIFE

Super fast installation
thanks to CAN bus connec-

CNA- CAN bus alarm systems

HPS 844N is an alarm system that can be coupled with the original remote control of the vehicle via CAN BUS (Controller Area Network)

This technology not only simplifies and speeds up the installation procedure, but also increases the security of the alarm system.

HPS 844N is a UNIVERSAL alarm system compatible with all motorhomes. In addition to being used with the vehicle's original remote control, another CNA remote control (optional) can be added that has variable and encrypted codes.

The device has several alarm inputs to be able to connect different accessories:
therefore the all-round protection of the vehicle is guaranteed.



Technical data: Current consumption with switched on Alarm <3,5mA, supply voltage 11-15 Volt, operating temperature -40° C - +85° C, Dimensions control unit: 83x62x26 mm, weight 97 g.

① Alarm System HPS844N + HPS55 Ultrasonic

Scope of delivery:

modules, PINtoPIN OBD connector, siren and 4 transmitters 2.4 GHz

HPS 844 Fiat Ducato Euro 5 47444 458,99

HPS 844 Fiat Ducato starter kit, scope of delivery: alarm system, radio remote control, 2 radio magnetic contact switches, 2 batteries for magnetic contact switch, bonnet contact, control LED, wiring, installation material, instructions

474441 269,90

Accessories:

② Radio remote control 2,4 GHz	47448	63,90
③ Wireless sensor with magnetic contact for monitoring windows and garage doors	47447	63,90
④ 2,4 GHz Radio cable loop	474400	94,90



NEU

HPA975B

2,4 GHz-FUNK-Fahrscheife, um auch die
Infrarot-Gitter-Abwehr des Fahrzeuges zu
sichern. Wie z.B. Fahr- und Motorräder,
Schlüsselanhänger, Campingzubehör usw.

LED LIGHTS



A++

ONYX Copilot
LED reading light with switch, black. 12 V/24 V, 0.5 W, 3,200 K, 20 lm, beam angle 120°, energy efficiency A+, service life approx. 20,000 h. Length approx. 460 mm (Photos: Osram)
 2 versions:

① screw mounting	833081	27,91
② cigarette lighter	833082	27,91



A+

ADRIA
With Adria built-in

USB **12V LED**

LED gooseneck light with USB

- Very long, flexible neck
- Ideal for mounting in the sleeping roof

with 2-step switch and 2x USB 5V/ each 1A. Chrome-plated aluminium. 12 V/1.5 W, 4,000 K, 105 lm. Beam angle 90°. Energy efficiency A+.

83321	44,90
--------------	--------------



A+ **12V LED**

Light with night light

- 2.1A USB socket in base
- With blue night light

Ideal for seating area or bedroom with switch. Chrome-plated steel. Normal white / blue night light, 10-14.4 V DC, 1 watt. 2-way switch. Energy efficiency A+

① With movable light, height: 120 mm, Ø 60 mm **832781 23,90**

② With flexible arm (approx. 140 mm), height: 230 mm, Ø 60 mm. 2-way switch. **832771 22,90**

USB port



12V LED **USB** **A++**

LED gooseneck light

Silicone coated, colour: black, 12 V with switch and USB charging socket 1.5 A. Length: 386 mm

① 1,2 W	83590	42,48
② 1,8 W	83591	42,49

USB port



CARBEST
INNOVATIONS FOR MOBILE LIFE

① ② ③ ④ ⑤ ⑥ ⑦ ⑧

TOUCH TOUCH TOUCH

270° swivelling

180° swivelling

12V LED **12V 24V**

12 V & 12 V/24 V LED line lights

① **LED line light 200 mm with touch switch, 12 V** Stylish appearance due to aluminium housing. 3.3 W, 18 LEDs, 185 lumen, 3,000 K, hole spacing: 8 cm. Dimensions: L200 x W30 x H10 mm. **83671 16,90**

LED line light with touch switch, 12 V Elegant appearance due to aluminium housing.

② Length: 400 mm 5 W, 27 LEDs, 360 lumen, 3,000 K **83674 20,90**

③ Length: 600 mm. 7 W, 42 LEDs, 470 lumens, 3,000 K, **83675 28,-**

④ **LED line light Mini with on/off switch, 12 V** Stylish look with aluminium housing. 3.6 W, 18 LEDs, 126 lumen, 3,000 K, plastic end caps. Dimensions: L347x W16 x H21 mm. **835571 31,-**

LED line light with on/off switch, 12/24V Elegant appearance due to aluminium housing. IP65.

⑤ **Length 225 mm:** 2 W, 10 LEDs, 180 lumen, 3000 K. **83241 17,90**

⑥ **Length 470 mm:** 6 W, 30 LEDs, 520 lumen, 3000 K **83242 37,90**

LED line light with on/off switch, 12/24V Stylish aluminium housing, IP 65

⑦ **Length 266 mm:** 3.6 W, 18 LEDs, 340 lumens, 3000 K. **83243 18,90**

⑧ **Length 468 mm:** 7.2 W, 36 LEDs, 570 lumens, 3000 K. **83244 33,90**

*Intended use of all lights and lamps in this catalogue: For exclusive 12V battery operation and use in recreational vehicles.

Professional LED flex bands for effective, individual lighting



- Atmospheric lighting indoors / outdoors
- Pleasant, bright warm white light colour
- All LED flex strips are dimmable
- Self-adhesive, can be shortened after every 3rd LED
- Insensitive to vibrations in the vehicle

12 V LED flexible tape Topview for indoor and outdoor use
 30 LEDs/m, 2.4 W/m, 187 lumen/m, 3,000 K, IP66, energy efficiency A+, warm white, 5 m roll, strip width: 8 mm
83174 22,90

12 V LED flexible strip Topview for indoor use
 60 LEDs/m, 4.8 W/m, 390 lumen/m, 3,000 K, IP20, energy efficiency A+, warm white, 5 m roll, strip width: 5 mm
83172 34,90

12 V LED flex strip Topview for indoor and outdoor use
 60 LEDs/m, 4.8 W/m, 390 lumen/m, 3,000 K, IP67, energy efficiency A+ warm white, 5 m roll, strip width: 8 mm
83171 39,90

12- V LED flex strip Topview for outdoor use
 120 LEDs/m, 9.6 W/m, 780 lumen/m, 3,000 K, IP67, ideal as awning lighting, incl. 1 m connection cable (waterproof), energy efficiency A+, warm white, 5 m roll, strip width: 10 mm
83170 64,90



i In LED strip lighting with 120 LED's the light appears continuous, with 30 or 60 LED's individual points of light are clearly visible.

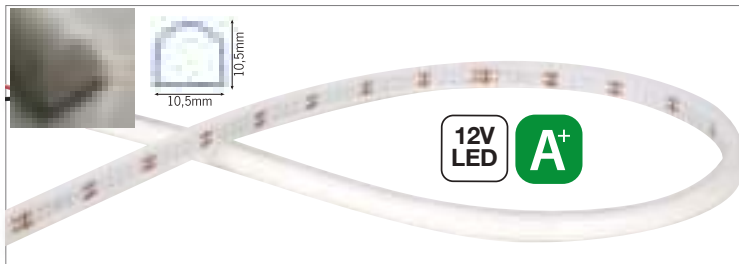

Flexible LED light tube for indoor & outdoor use

Length of light tube: 5 m, width and height: 10.5 mm, 10.8W, 150 LEDs/m, 620 lumen, 3000K. Self-adhesive, dimmable and can be shortened. IP67.

83178 84,89

End cap set for LED rope light 83178, set with 2 pieces
831781 2,50

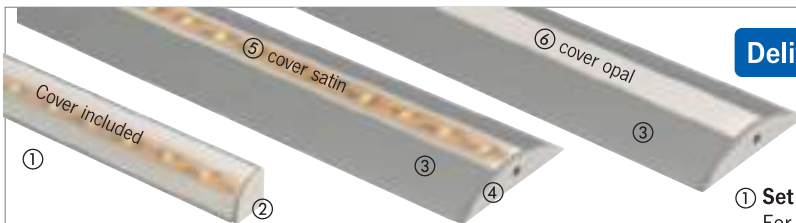

Delivery without LED strips

Stylish aluminium profiles for LED strips

- For atmospheric lighting
- Suitable for our LED strips
- Profile length: 1.5m

The aluminium profiles are a professional solution for the installation of LED strips. Ideal also for furniture construction, e.g. to cover the transition of different wooden panels or to illuminate stylishly.

For the light diffusion you have the choice between the semi-transparent satin cover or the white appearing opal version. 2 end caps are included with each set

- 1 Set of angle aluminium profile incl. cover and 2 end caps**
 For mounting in corners and under cabinets. Length: 1,5m
829991 15,99
- 2 End caps (2 pieces) for 829991 82981 1,99**
Fixing clips (2 pieces) for 829991 (not shown) 829810 1,99
- 3 Set of aluminium profile half-round incl. 2 end caps.** For screwing on and for covering transitions of e.g. furniture panels. Length: 1,5m
829992 15,99
- 4 End caps (2 pieces) for 829992 82982 1,99**
Cover, length: 1,5 m, for 829992
- 5 satin (semi-transparent) 82983 6,99**
- 6 opal (white) 82984 6,99**

For further product information and current prices, see the Reimo Accessories Professional catalogue or www.reimo.com

SURFACE-MOUNTED / RECESSED / OUTDOOR LIGHTS

CARBEST
INNOVATIONS FOR MOBILE LIFE

① 12V LED

Super flat LED panel

- Only 5 mm thick
- Chic silver frame
- Warm white light with 3,000 K

① 12 V/6 W, dimensions: 100 x 200 mm **833691** **34,-**

② 12 V/3 W, dimensions: 100 x 100 mm **83369** **21,90**

2,0 m | 100° | WARM WHITE

12V LED

LED surface light

Made of polycarbonate with removable magnetic frame for concealed mounting. 12 V, 250 lm, beam angle 120°. Dimensions: 100 x 100 x 7 mm

Brushed chrome **83587** **16,90**

① 12V LED

LED recessed/under-cabinet light

Modular system with freely selectable housing shapes

① 12V LED recessed/under-cabinet luminaire, 3,4 W, 240 lumen, 6 LEDs, 3000K. Material: aluminium. Energy efficiency A+. Supplied without connection cable. (The 835802 cable is essential for connecting the luminaire)

② Under-cabinet housing round, flat, colour: matt black, material, plastic, dimensions: 65 x 2,6 mm **83581** **2,99**

③ built-in housing round, high, colour: black matt, material, plastic, dimensions: 65 x 15,6 mm **83582** **2,99**

④ Recessed housing square, flat, color: black matt, material, plastic, dimensions: 65 x 65 x 2,6 mm **83583** **2,99**

⑤ Recessed housing, square, high, colour: black matt, material, plastic, dimensions: 65 x 65 x 15,6 mm **83584** **2,99**

⑥ Connection cable 1000 mm, suitable for recessed/underground light 835801, with snap-in connector **835802** **2,75**

Van-Pro rain gutter with integrated lighting

- Suitable for Fiat Ducato 244-250-290 as well as Peugeot Boxer & Citroen Jumper from 2006 (left-hand drive version)

12V, 8,4 W, 370 lumen, current consumption: 700mA, light colour warm white 4000K, material: aluminium, matt black. The light provides a pleasant light in front of the vehicle and at the same time drains rainwater. It is mounted under the upper pillar of the sliding door. Dimensions: LxWxH 1500x36x7 mm. Weight: 440g. IP65. **83451** **117,-**

12V LED

LED under-cabinet light

Colour: black, with silverf. Edge, 12 V/2 W, with touch switch and USB charging socket 1,5 A. Dimensions (LxWxD): 160 x 79 x 50 mm **83596** **31,94**

CARBEST
INNOVATIONS FOR MOBILE LIFE

12V / 24V

LED awning light for panel van

12/24V, colour: black, length: 231 mm, IP67, 3000K, 4,5W, 9 SMD LEDs, 530 lumen, ABS housing. **833771** **21,90**

For further product information and current prices, see the Reimo Accessories Professional catalogue or www.reimo.com



CARBEST
INNOVATIONS FOR MOBILE LIFE



LED Torch Light with Bluetooth Speaker

Cosy LED light with flame effect and integrated Bluetooth speaker. Volume >90dB. Transmission range >10m. Power supply: 5V 1A. Output power: 5W. 2000mAh Li-polymer battery. Charging via Micro-USB. Material: ABS. Dimensions: Ø 98 x H165 mm

83184 27,99



CARBEST
INNOVATIONS FOR MOBILE LIFE

Rechargeable camping light with insect killer

3.7 Volt, 2000mAh. Li-polymer battery, charging via micro USB. Hook for hanging integrated. Material ABS. Dimensions: Ø 88 x 129 mm. Lighting levels 20% - 50% - 100% - Off. Weight: approx. 200 g

83494 24,99

CARBEST
INNOVATIONS FOR MOBILE LIFE

Powerful COB-LED-technology from Carbest

① **Solar/230V/12V Camping Light**
Rechargeable LED camping light with integrated solar panel from the lid. Charging via solar, 230 V or 12 V adapter. With USB port 5 V / 1 A for charging mobile phone & Co, 500 lumen, 4.000 mAh battery for very long lighting time. 3 light settings: very bright (approx. 4 h) and flashing mode (approx. 8 h). Dimensions: D: 82 x W: 82 x H:82 mm

834871 44,99

② **Battery camping light** Powerful 3 W COB camping light (500 lumen), battery operation (3 x D battery not included), dimensions: 82 x 82 x 182 mm, weight: approx. 394 g, battery life: approx. 4 h

834872 26,99

Connection example 12 V - system with Check - Panel 713

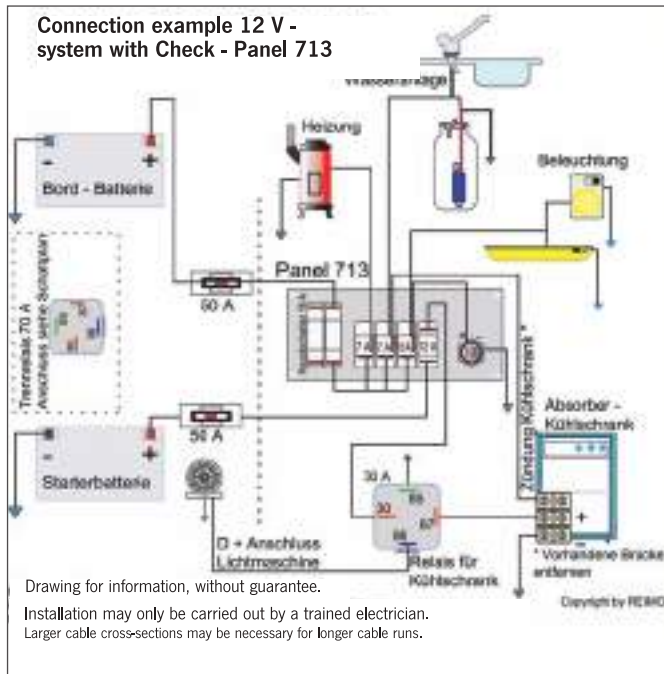

Connection example of a CEE system

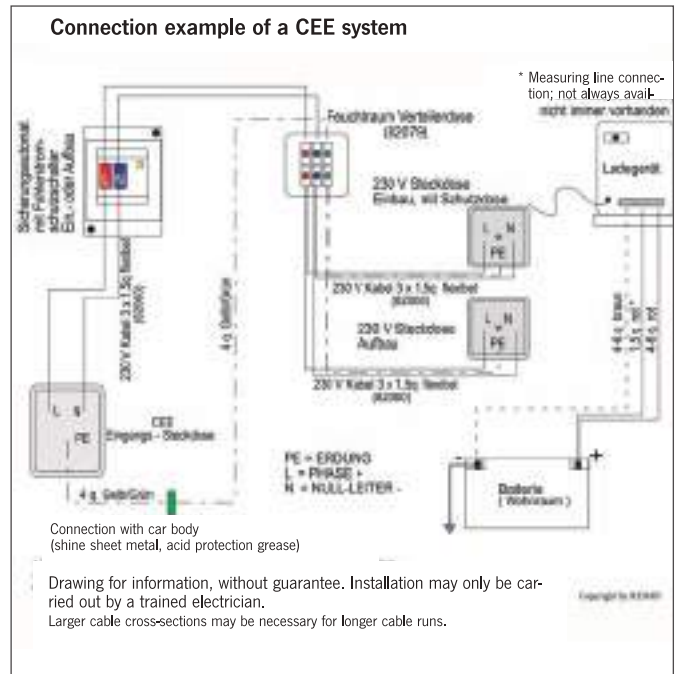

Installation diagram gas system

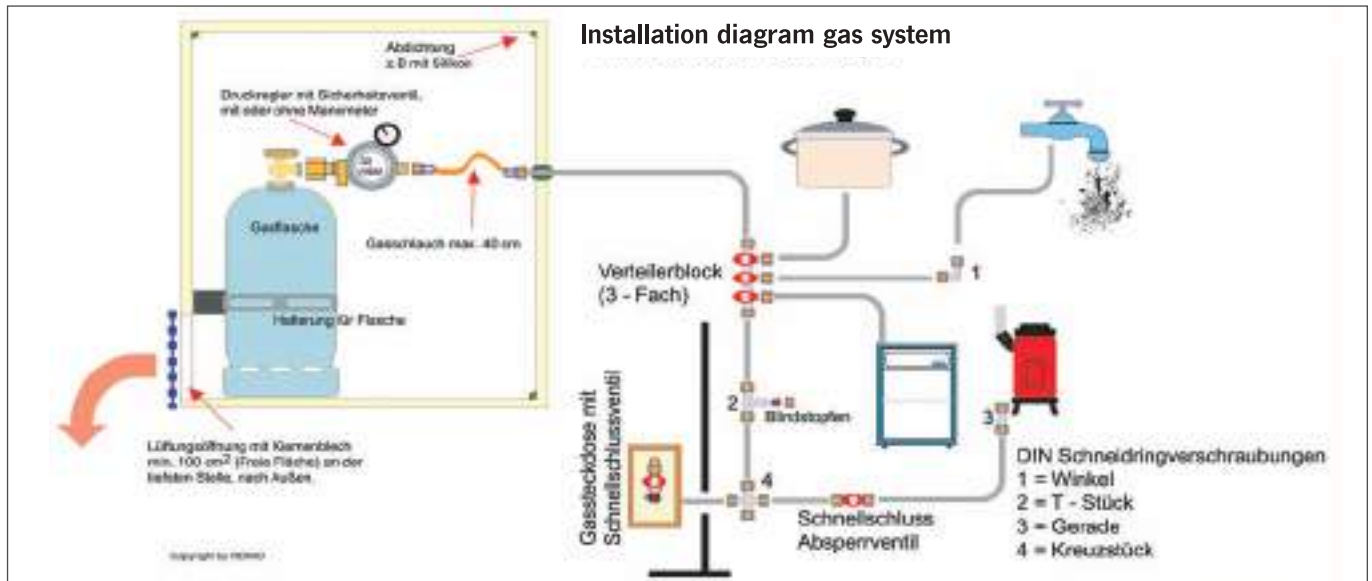

Satellite system with positioner

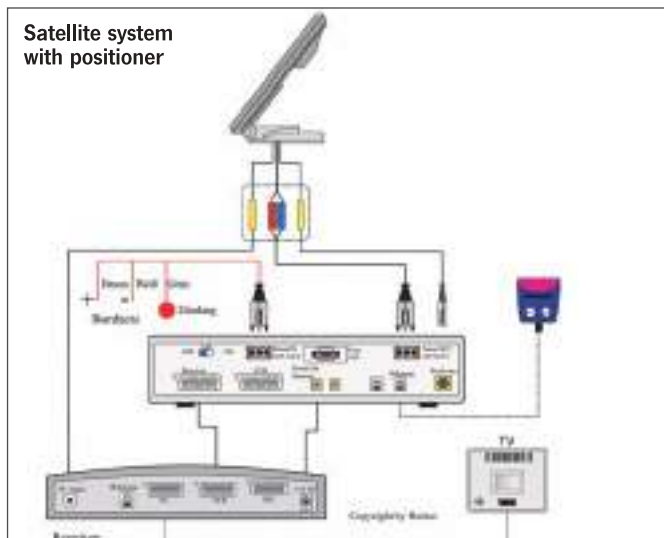

Large solar plant

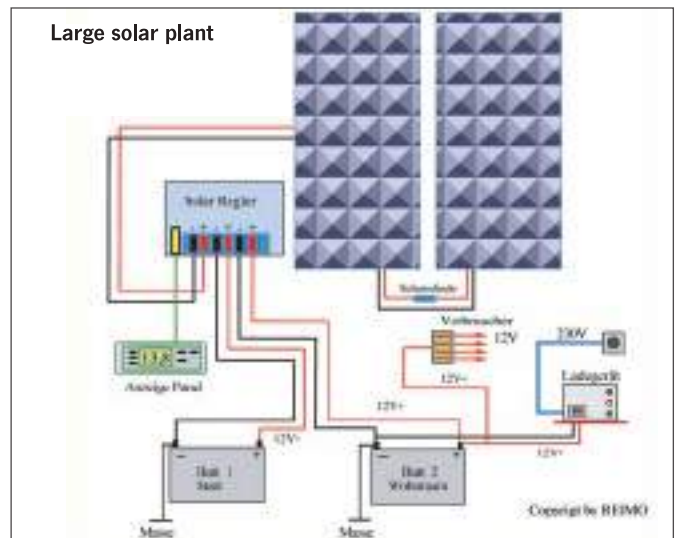

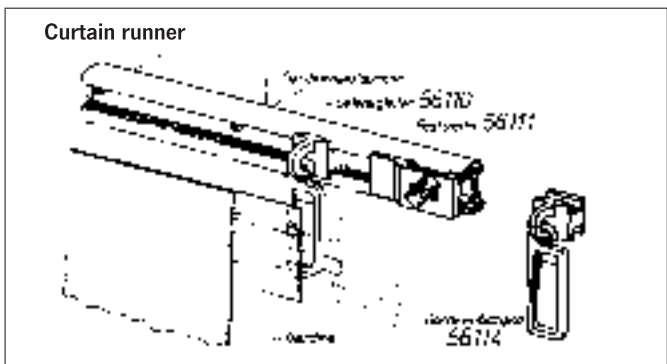
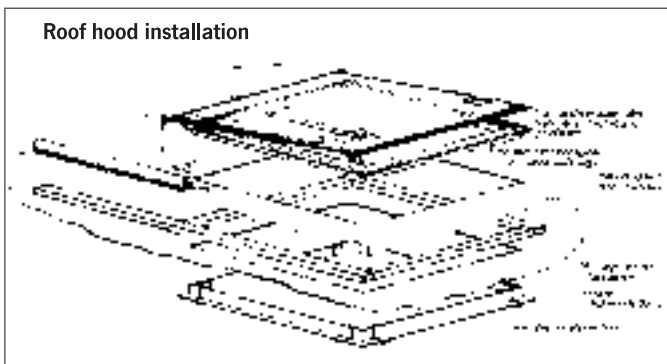
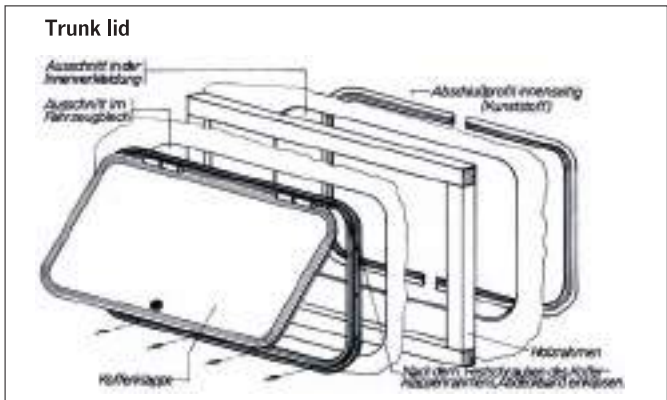
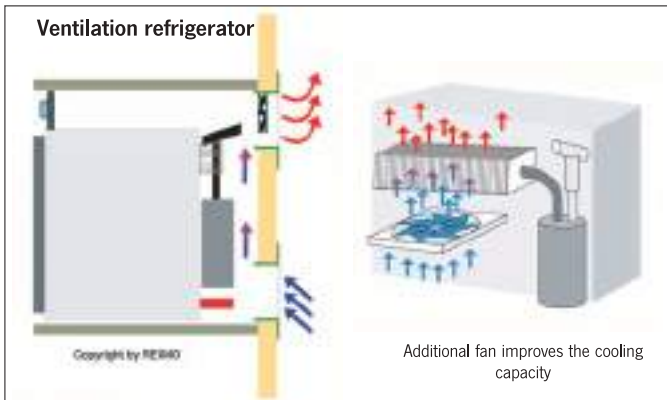
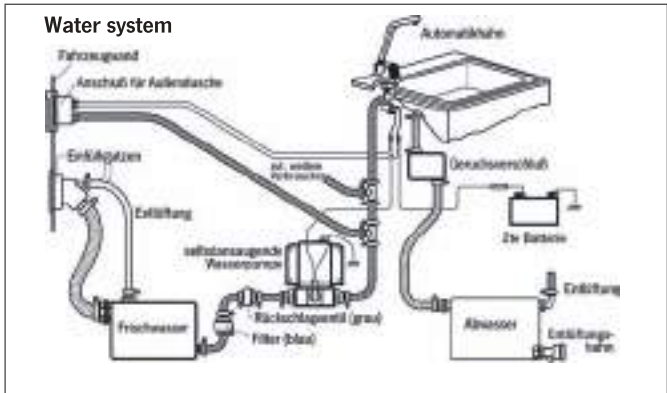
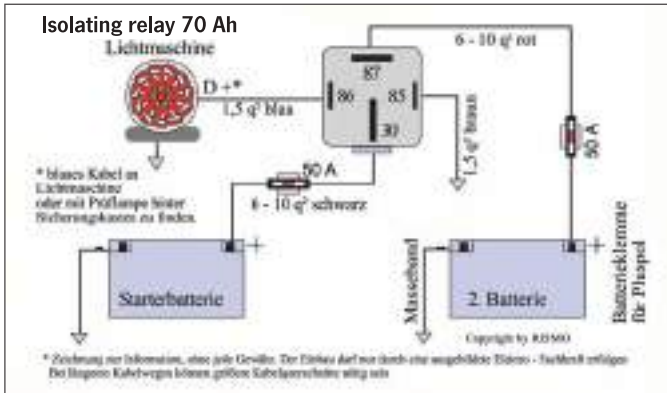
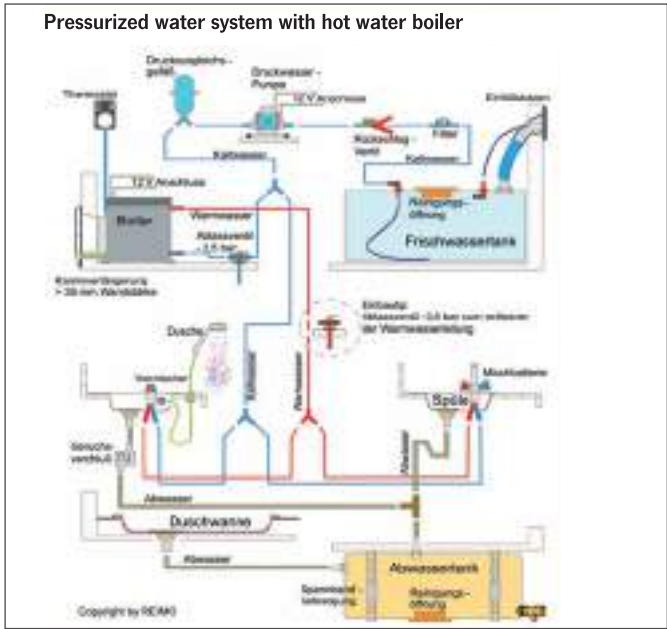
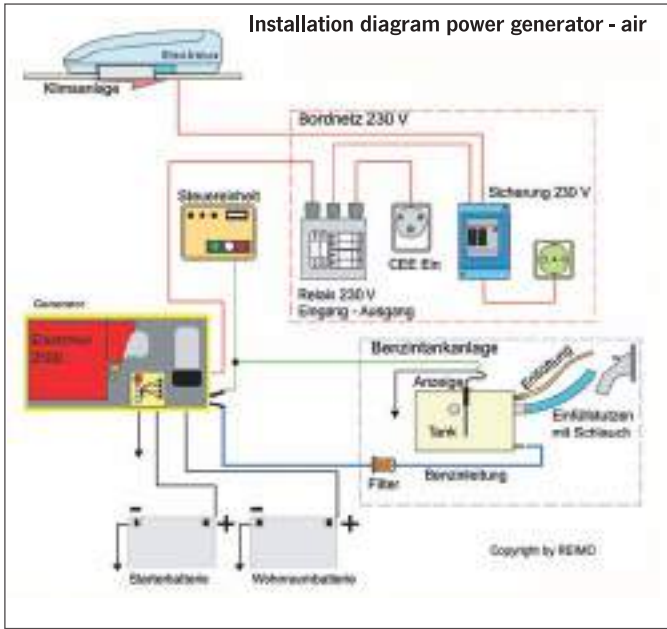

All drawings for information, without any guarantee.

GUTTER HIGHRAIL



The Reimo Highrail, Multirail and Caddy keder rails are suitable for keder rails of Ø 7 mm. Keder rails for Ø 8 mm are fitted as standard on the Volkswagen California



Highrail- profile structure

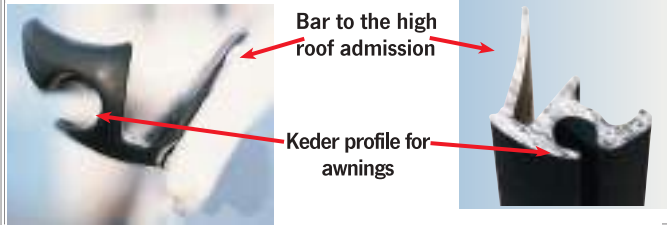

Mounting

- Is screwed to the vehicle with stainless steel screws. In addition, glue the profile to the car body with the TÜV-approved special adhesive.
- The rail is offered in several lengths, some pre-drilled and countersunk
- Separate end piece set includes stainless steel screws and installation instructions
- Special adhesive Sikaflex 252i (Art. No. 294132) is required for installation
- Use Sika adhesive cleaner (29415) or petroleum ether to degrease the contact surface.

CARBEST

INNOVATIONS FOR MOBILE LIFE

Multifunctional rail Highrail with rain gutter -
For high roof mounting VW T4/T5/T6/T6.1

- Ideal for VW T4 (installation on T5/T6 recommended by specialist company)
- As rain gutter and for mounting awnings or sun roofs
- As roof rack mounting only permitted for VW T4
- Well suited as a mount for high roof mounting (without end pieces) for Fiat Ducato, Peugeot Expert, Citroen Jumper with original bodywork
- Made of high-quality aluminium alloy, anodised in black
- Front and rear parts (end pieces) made of PUR (polyurethane) create an elegant transition to the bodywork
- For keder thickness 7-8 mm

① Highrail Black		
Profile rail pre-drilled, black anodized. Accessories see end piece set		
KR Profile length 2750 mm	90149	119,90
LR Profile length 3400 mm	901451	109,90

② End piece set		
(front spoiler and rear end incl. stainless steel screws)		
Stainless steel screws		
black and silver as well as mounting instructions:		
For passenger side right,	90146	80,75
For driver side left,	90147	80,75

Special adhesive - Sikaflex 252i -		
300 ml absolutely necessary for mounting!		
Black, GP* 79,93 / 1 Liter	294132	23,98
Adhesive Cleaner 0,25 Ltr GP* 92,48 / 1 Liter	29415	23,12

Attention for special glue and adhesive cleaner

= Plus freight flat rate Highrail (1 - 10 pieces) V25 25,89



Keder rail- for VW Caddy My. 2003-2020

Rail is glued in. The roof only has to be unlocked to pull the piping into the rail. For keder thickness 7-9 mm . Plastic hard PVC, Length 3 m

901151 19,55

Folding suction cup - Fastening without drilling

- For screwless, horizontal or vertical fastening of canopies, awnings, etc.



- | | | |
|---|--------|-------|
| ① Folding suction cup plastic Ø 100 mm loadable up to approx. 10 kg, 1 pc | 93648 | 12,99 |
| ① Foldingsuction cup plastic Ø 120 mm loadable up to approx. 15 kg, 1 pc. | 936480 | 16,99 |
| ② Folding suction cup cast aluminium Ø 120 mm plate of natural rubber, loadable up to approx. 10 kg, with screw for various fixings, 1 pc | 93647 | 42,60 |
| ③ Folding suction cup for fastening the lock rod Ø 55 mm Loadable 5 - 8 kg, 1 pc | 93646 | 37,49 |



Magnet adapter set (3-piece)

For simple and quick attachment of the awning to the vehicle without Multirail. With the magnetic tape, your awning can be securely attached to the car.

Scope of delivery: magnetic tape with keder profile (length 283 cm), 3x double keder rail 90 cm each, keder tube.
1 set 904490 36,-

Multirail - rain gutter, sun sail and roof rack attachment in one

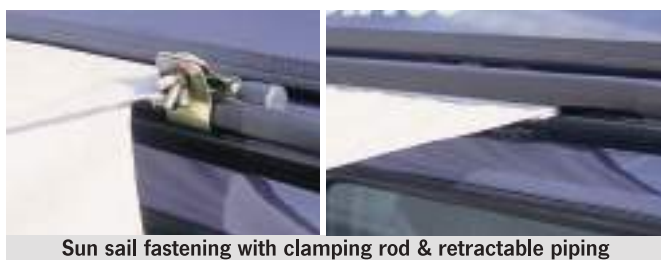

- Rain gutter for awning and roof rack
- Easy attachment of awning and awning with clamping rod or pull-in piping
- Easy mounting of the self-adhesive spoiler profiles
- The aluminium rail is already pre-drilled
- Absorption of roof loads up to 100 kg
- For keder thickness 7-8.5 mm

In combination with conventional roof racks you can transport bulky goods such as kayaks, bicycles or surfboards. The **Multirail** can also be fitted to vehicles with sleeping or pop-up roofs. Here the maximum roof load is 50 kg, approved by VW. The **Multirail** protects you from rainwater running off when the side windows and doors are open by means of the spoiler profile (please order separately)

The Multirail is attached to the vehicle with a special adhesive (Sikaflex 252i, see left side).

Vehicle type	Model	Multirail Art. no	Price 	Spoiler set* Art.no.	Price
For VW T4/T5/T6/T6.1, special version	KR/SWB Left (driver's side)	901561	177,99	90154	66,25
	KR/SWB Right (passenger side)	90156	177,99	90155	66,25
	LR/LWB Left/Right	90157	194,99	90154 Left 90155 Right	66,25 66,25
For Mercedes Vito, Viano, V-Class, Marco Polo, Metris, vehicle length 4990/5140 mm, all from 2003 onwards	Left (driver's side)	901851	249,-	90154	66,25
	Right (passenger side)	90185	249,-	90155	66,25
For Renault Trafic, Nissan NV 300, Fiat Talento, from year of construction 8/2014 and Opel Vivaro B, My. 8/2014 - 3/2019 all KR	Right (passenger side)	90184	174,-	901550	29,90
For Citroën Spacetourer/Jumpy, Peugeot Traveller/Expert, Toyota Proace, all from 3/2016; Opel Vivaro C/Zafira Life from autumn 2019 and Pössl Campster/Vanster/Campy vehicle length 4950 mm	Left (driver's side)	90178	279,-	90154	66,25
	Right (passenger side)	901780	279,-	90155	66,25
Multirail Universal, can be shortened	Left or right	90153	143,99	901550	29,90

 = Plus freight flat rate Multirail(1 - 10 pieces) V25 25,90

* Spoiler set consisting of front spoiler, rear end (self-adhesive), stainless steel screws and assembly instructions. Must be ordered separately.

SUN SHADE



Sun shade Charlyne for Minicamper

Connection keder profile o. with lock rod

Material: 210D Oxford-Polyester

Frame: steel

Size 1 Dimensions: 180 x 240 cm, Pack size: 90 x ø10 cm, Weight: approx. 3.8 kg
90066 79,99

Size 2 Dimensions: 220 x 240 cm, pack size: 110 x ø10 cm, weight: approx. 3.9 kg
90068 84,89



Como - The universal canopy

- Extremely tear resistant
- Weatherproof, waterproof and washable
- Keder connection Ø 5+8 mm

Colour: light grey or anthracite, edging in blue

Scope of delivery: sun shade Size 1 and 2 with two poles, from size 3 with three poles, pegs and guy ropes

Light grey, depth: 240 cm

Size 1 200 cm 2,5 kg **90020 79,90**

Size 2 250 cm 3,0 kg **90021 89,90**

Size 3 300 cm 3,5 kg **90022 99,90**

Anthracite, depth: 240 cm

Size 2 250 cm 3,0 kg **900212 89,90**

Size 3 300 cm 3,5 kg **900222 99,90**



Sun sail Charly for buses

2 telescopic steel erection poles, sewn-on keder profile 6mm

Size 255 x 240 cm **90049 84,99**



Tech-Line Canopy

- Now available in 3 mounting heights
- Side windows to open and roll up
- Side walls with clear windows
- Vehicle connection: 5+7 mm keder profile

Beautifully designed Sun shade with side panels that can be stowed to the side. Easy to set up with only one steel pole

Scope of delivery: sun sail, steel pole, reflective storm lines, pegs, pack sack

Lowline **900161 199,-**

Midline **900162 239,-**

Highline **900163 249,-**

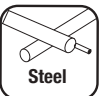

Sun sail Maritius M + L + XXL

Loops for suction cups or keder profile 6mm

Material: 300D RipStop Polyester

Water column: 2000 mm

Frame: steel

M Caddy W 460 x D 300 cm **900575 119,-**

L Bus W 510 x D 300 cm **900573 139,-**

XXL Caravan W 560 x D 300 cm **900572 169,-**

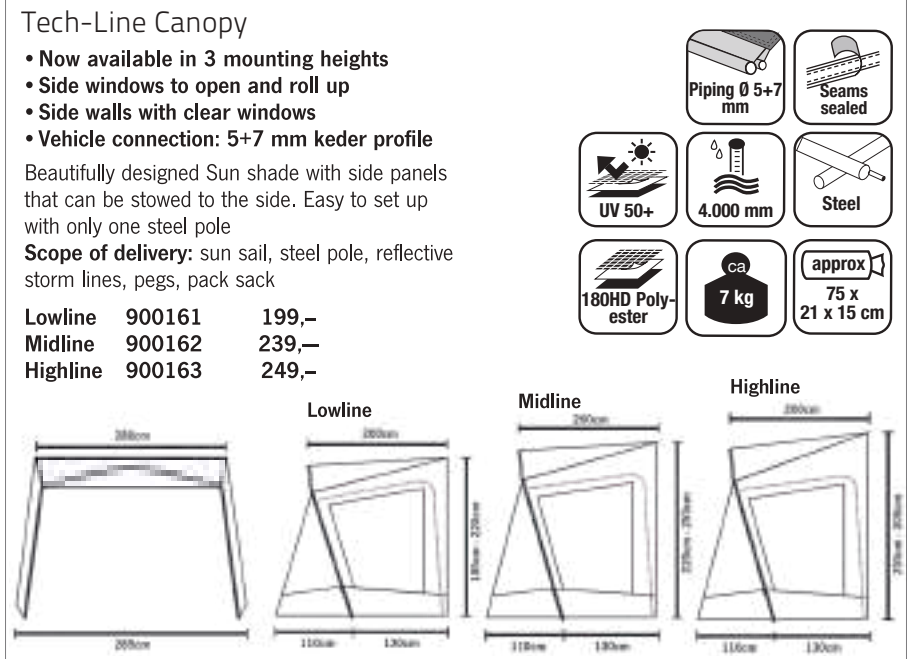

For further product information and current prices, see Reimo accessories professional or www.reimo.com



Sun sail Palm Beach 2 2.6 and 2 3.0

- Robust sail with 240 cm depth - piping connection 5 + 8 mm

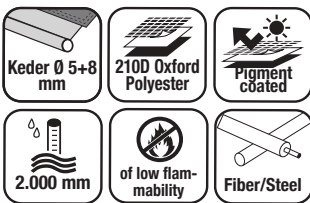

Matching side walls for Palm Beach 2

- With coverable mesh window - attached to the sun sail with Velcro tape

Palm Beach side wall: Bus sliding door can be opened unhindered thanks to its 2.25 m width .Dimensions: W 225 x H 180 cm, weight: 2.2 kg **900153 89,99**

Side wall Palm Beach Space: Side wall can be extended further thanks to the 2 m height .Dimensions: W 240 x H 200 cm, Weight: 2.5 kg **900154 96,-**

Catalina Pavilion 3 x 3 meters

- Incl. 1 closed side panel, 1 closed side panel with door and 2 side panels with mosquito net inserts
- Quickly erected

Tent-pavilion/party-shelter with fibreglass poles for party, beach and holiday. Versatile use - as a decorative eye-catcher, protection from wind, weather or prying eyes
The four side walls can be easily, quickly and simply attached and detached using the zips
Two of the side walls have mosquito net inserts for good ventilation and protection against mosquitoes, even when the walls are closed.

Material: 100% 190T polyester

Poles: PU fibreglass, 8.5 mm

Dimensions: W300 x H220 x D300 cm

Packing size: 62 x 17 x17 cm

Scope of delivery: pavilion, fibreglass poles, 4 side walls

Pavilion Catalina 90556 119,99



Palm Beach 2 2.6:
ca. **5,4 kg**
approx **74 x 16 x 16 cm**
900151 129,-



Palm Beach 2 3.0:
ca. **6.8 kg**
approx **74 x 16 x 18 cm**
900152 139,-

Mauritius Premium - Sun sail with roll-up side walls

- Sun sail with sewn-on side walls that can be tensioned or rolled up as desired
- Dome roof has 2 fibreglass diagonal poles to prevent water bagging
- High quality premium material
- Including 2 locking pieces for keder rail for optimal fixation
- Double piping Ø 5 + 8 mm
- Available in 2 designs: light grey/anthracite or completely anthracite

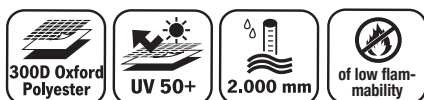

Dome roof, no water pockets

Versions	Color	Weight	Pack size	Ar-No.	Price
Width: 260 cm	Light grey	9 kg	L: 90x Ø 20 cm	900155	229,-
Width: 300 cm	Light grey	10 kg	L: 90x Ø 20 cm	900156	269,-
Width: 260 cm	Anthracite	9 kg	L: 90x Ø 20 cm	900157	229,-
Width: 300 cm	Anthracite	10 kg	L: 90x Ø 20 cm	900158	269,-





Privacy screen/shower curtain for van tailgate

- Shower without getting the rear wet
- Suitable for almost all panel vans (details at www.reimo.com)

The privacy screen can be used with or without a rear awning (no tight seal). Simply fasten it over the tailgate with the adjustable strap and fix it to the bumper with plastic hooks if required. Water column 2,000 mm, dimensions: 153 x 186cm, colour grey,

936287 29,90



Rear tent Vertic Traffic
For Renault Trafic, Ford Transit Custom, Fiat Talento, Opel Vivaro, Nissan NV 300, Citroen Space-tourer, Jumpy, Campster, Peugeot Traveller, Expert, Toyota Proace, all from 2015 and Opel Vivaro C, Opel Zafira Life from autumn 2019. with tailgate

93797 159,-

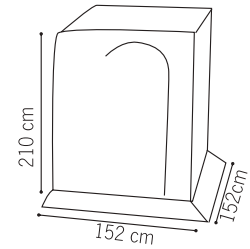
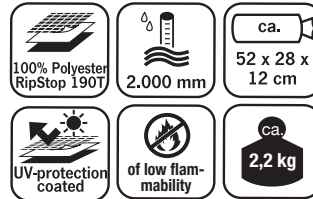

Rear tent Vertic

No poles required, quick set-up.

VW Caddy KR and LR until 2020 **93792 117,91**

VW Kangoo II from 2008 **93795 117,91**

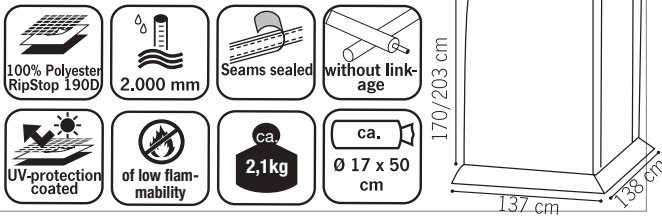

Rear tent trapeze

No poles required, space for camp bed.

For Caddy My, 04 -20, Kangoo, Doblo, Partner, Berlingo, Citan **93791 127,90**

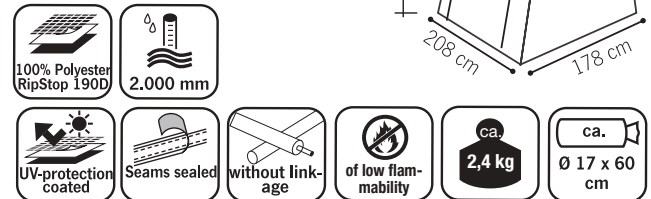
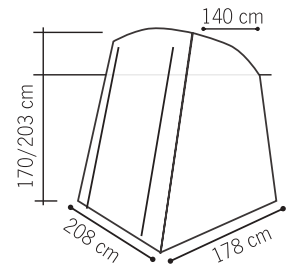

Rear tent Instant

- No poles required
- For VW T5/T6/T6.1 with tailgate

The rear tent is sewn to the tailgate and is attached to the tailgate with press studs (still to be attached). **93790 149,90**

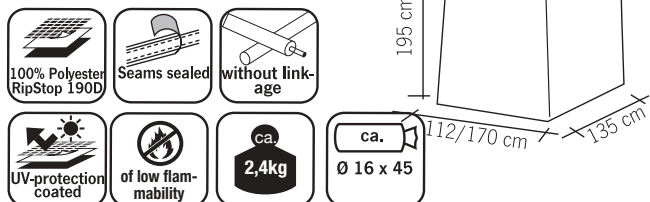

Rear tent Fritz Rear

- For VW T5/T6/T6.1, Vito, Renault with tailgate

The practical small rear tent for vans, buses and small motor-homes. Fastening to tailgate lock and by means of straps.

Scope of delivery: tent skin, tensioning pole, guy ropes, pegs, pack sack

900131 139,90

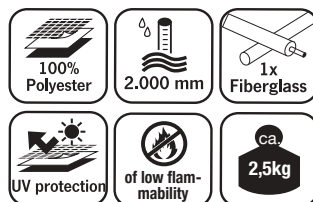

For further product information and current prices, see Reimo accessories professional or www.reimo.com

Upgrade Premium - Rear tent with Premium equipment for VW T5/T6

- All 3 doors with mosquito net zipped doors
- Sewn-in floor pan, closes with rear entrance
- PVC windows in the roof
- Space for a camp bed
- Meets Australia requirements

No poles, small pack size, light weight and easy pitching make the Upgrade Premium rear tent the perfect rear tent for van drivers. New features such as mosquito netting in all zipped doors, skirt to bumper and sewn-in groundsheet provide added comfort. The front door can be set up as a sun awning and the two side entrances have tinted windows

Scope of delivery: rear tent, guy ropes, pegs, 2 poles and pack sack **936286 249,-**

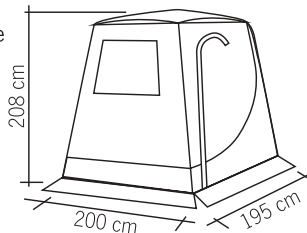

--	--	--	--	--	--	--	--

Upgrade 2 - More living space for VW T5/T6/T6.1

- No linkage required
- Small weight
- PVC windows in the roof
- Space for a camp bed
- Changing room at the bathing lake or shower tent at the rear
- For VW T5/T6 with tailgate

No poles, small pack size and easy set-up make the Upgrade 2 rear tent the perfect choice for all van drivers. Simply put it over the tailgate and there is room for a camp bed, bicycle or simply to get more fresh air in the vehicle. Front can be raised as a sun awning. Tinted windows and entrance in both side walls **Scope of delivery:** Tent, guy ropes, pegs, 2 poles and pack sack . Colour Grey/Anthracite/Lime **936280 149,-**

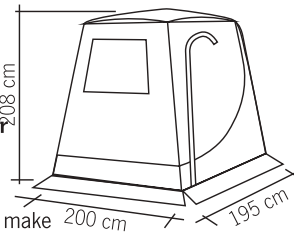

--	--	--	--	--	--	--	--

Trapez Trafic - rear tent without poles

- Both side walls and rear wall with door
- Tinted windows with inner cover
- Mosquito net window
- With window in roof as skylight

Suitable for Renault Trafic and identical vehicles, Nissan NV 300, Citroen Spacetourer, Jumpy, Campster, Peugeot Traveller, Expert, Toyota Proace, from YOC 2015 with tailgate

With extra large interior, for camp bed, bicycles, etc. Simply pull the rear tent over the open tailgate and fasten it to the floor. The rear wall with mosquito net window can also be used as a sun sail.

Scope of delivery: tent skin, including storage bag **93796 189,-**

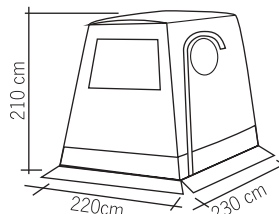

--	--	--	--	--	--

DRIVE AWAY REAR TENTS

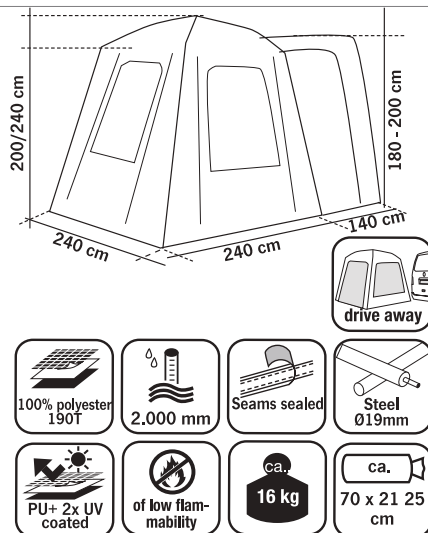

Uni Van - universal rear tent for minicampers and vans

- Side walls and rear wall with door
- Ventilation in roof and floor
- Tinted windows
- Extra long airlock with doors on both sides

Both side walls and front wall with door which can be used as a sun awning Air circulation through ventilation in roof and floor. Extra long airlock with doors on both sides (140/180 cm). Attachment to the vehicle: Simply pull it over the open tailgate and tie it off to the side with pegs

Scope of delivery: tent skin, poles, guy ropes, pegs, pack sack

93798 329,-

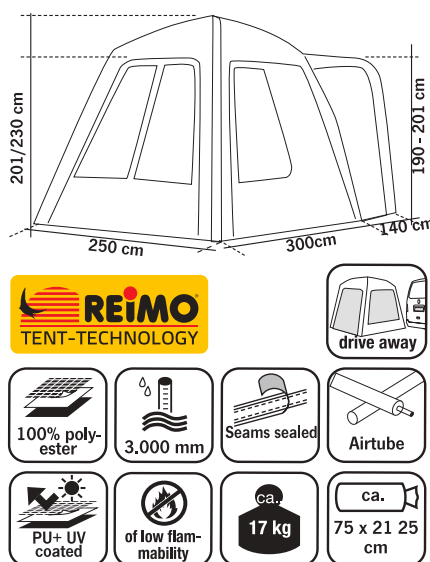

Uni Van Air - Inflatable universal rear tent for buses

- Side walls and rear wall with door, completely removable, with 1/3 mosquito net
- Top vent and tinted windows
- Extra long airlock (140 cm) with doors on both sides
- With tent floor to zip in

Cross dome rear tent with air tube technology, quick and easy to set up! Both side walls and front wall with door, which can be used as a sun awning or removed completely. Air circulation through ventilation in the roof and on the ground. Attachment to the vehicle: Simply pull it over the open tailgate and pull it off to the side

Scope of delivery: tent skin with air tubes, air pump, guy ropes, pegs, pack sack

937981 548,99



Movelite 1 - With new equipment

- Canopy over entrance
- Sewn-in tent floor
- Extension height 180 to 255 cm

The proven Movelite 1 with improved features such as lock with mosquito net door, entrance with sun canopy, roof ventilation on right and left side and both side doors with mesh panels for better ventilation. Seams sealed. **Scope of delivery:** tent with air tubes and floor, fibreglass pole for sun canopy, roof reinforcement, air pump, tension and storm ropes, pegs, pack sack.

936947 879,-

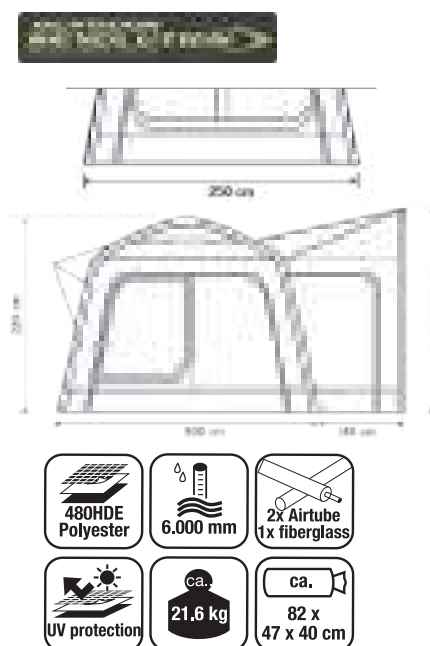

Movelite 1 - Inflatable Rear bus tent
Rear tent with only one inflation point, fits from VW T5/T6 to Fiat Ducato.

Mounting height 180-240 cm

Dimensions see left 93799 749,-

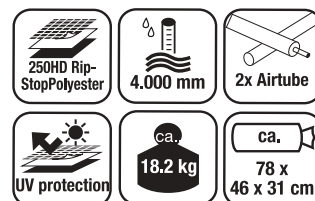



Awning Antigua Air

- Practical sun awning, can also be used as an awning
- Quick assembly with only one air hose
- Large windows with cover inside
- 4 vehicle connections (keder Ø5+8mm, lock rod and loops)
- Including detachable side walls (hooks) and front (zipper)

For camping buses with a keder rail height of 1.80 to 2.20 m. The sun awning becomes an awning through 2 hook-in side walls and a zip-in front wall. Both with windows and inner cover.

Scope of delivery: sun awning with air tube, 2x side wall / 1x front wall, 2x steel roof poles, guy ropes, pegs, packing bag

90688 399,-

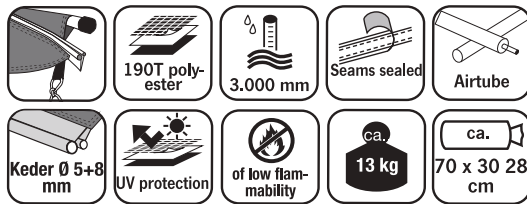

Sun sail Hispaniola

- Practical sun awning, can also be used as an awning
- Separate mosquito nets can be used instead of the tent walls
- Assembly with only one fibreglass pole

Multifunctional awning/ awning for camping buses with a keder rail length from 2.60 cm. The front and side panels are completely removable and can be stowed in the pockets sewn inside. Windows are equipped with tinted film. Fastening with 5+8 mm keder strip, clamping rod or guy ropes.

Scope of delivery: sun awning, fibreglass pole, clamping pole with clamps, guy ropes ,pegs, stuffsack.

90687 239,-

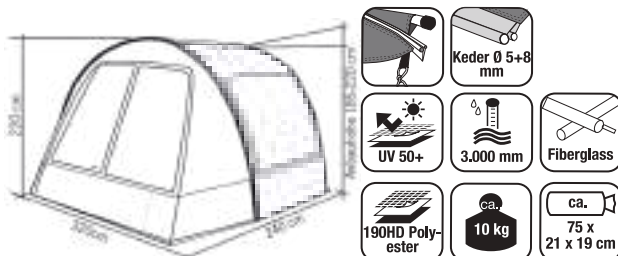

BUS AWNINGS



Tour Easy 4 - Compact COMFORT awning

- Large front and side walls with mosquito nets
- Hook-in floor
- With practical opening for power cable
- Optional inner tent available

1-tunnel bus awning with large door in the front that can also be used as a sun sail. The door in the right side wall can be rolled up or used as a sun sail. Both side walls have large windows with inner cover and floor vents. The airlock to the vehicle has a door on the left side. The front has an additional mosquito net insert, the windows in the side walls are equipped with 1/3 mosquito net and 2/3 transparent PVC windows with inner cover. A power cable can be laid through a practical opening in the floor vent. **Vehicle connection:** Keder Ø 5 or 8 mm, lock rod or loops for fixing with tensioning lines. Mounting height 180 to 220 cm

Dimensions: W 300 x H 210 x D 270+lock 90 cm

936550 299,-

Large selection of other tents and all information about the bus tents on this page can be found in our accessories pro



Tour Breeze Air S, M & L - Perfectly ventilated

- Zippered piping connection for easy removal when tent is left standing
- Freestanding
- Transparent windows with extra large mosquito net inserts
- Front door can be used as awning
- Sewn-in PVC tent floor
- Storm bracing and air pump included
- 5 and 8 mm piping connection, lock pole or loops

Easy and quick to pitch air bus awning. The transparent windows in the front and side are equipped with large mosquito nets for optimum ventilation and with cover on the outside. The back wall of the airlock is also equipped with mosquito nets.

Size S: Attachment height 180 to 220 cm	936551	569,-
Size M: Attachment height 225 to 250 cm	936552	599,-
Size L: Attachment height 250 to 280 cm	936553	649,-

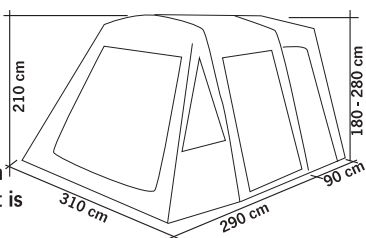

Movelite 2 - Air bus awning in 2 heights

- Only one inflation point
- Freestanding
- Tinted windows with curtains
- Optional awning available
- Sewn-in tent floor
- Storm bracing included
- 5 and 7 mm piping

Bus awning with many practical features such as tinted windows, fully opening front, side inflatable canopy, doors in the airlock, sewn-in floor and curtains. The doors are additionally equipped with mosquito nets.

Scope of delivery: tent with air tubes, air pump, tension and storm ropes, pegs, pack sack

Mounting height 180 to 220 cm	Lowline	936931	749,-
Attachment height 220-255 cm	Midline	936932	769,-

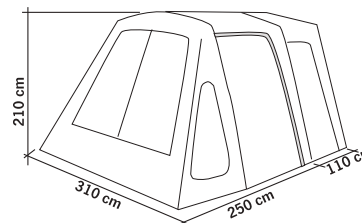



Tour Van Air - Comfortable awning

- Freestanding bus awning with only one air hose for the VW bus class
 - Tinted windows
 - 90 cm airlock with door
 - With floor in tent and airlock
 - Ø 5 + 8mm keder/lock rod or loop connection
- 900179 599,-

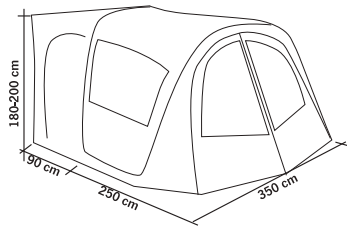

Tour Cap Air II - Large capacity tunnel tent

- Rain canopy over the entrance
- Transparent windows with cover inside
- Air tubes as roof reinforcement
- Sewn-in tent floor in the tent and separate floor to hang in the airlock, incl. windbreak to the vehicle
- With side entrance
- With practical opening for power cable
- 90 cm airlock with doors on both sides

2-tunnel awning with 3 air tubes with external valves. With transparent windows and mosquito nets in the side windows. Front door halo or fully openable. Large rainfly over entrance, side walls with windows, back wall with 1/3 mosquito netting. An inner tent is optional

9001784 638,99



Tour Van High Air

- For example for Fiat Ducato, Mercedes Sprinter
- Bus awning with only one air tube
- Large door with veranda function
- Separate awning - easy to attach with zip fastener over the entrance
- Floor included
- 5 and 8 mm piping/locking rod or loop connection
- Attachment height 225-250 cm

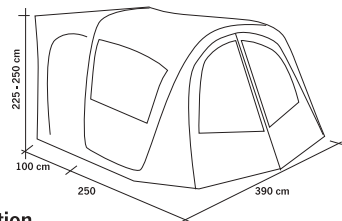

Scope of delivery: tent incl. air hose, air pump, sluice pole, sun awning, floor for sluice, 2 poles, pegs and ground nails, 3 roof poles, guy ropes, carry bag, colour: grey/anthracite/white 9001791 649,-

Optional inner tent 9001792 49,99



One Beam Air High - Only one air tube for quick setup!

- Large windows with privacy screen
- Front comes complete with mosquito netting and roll-up covers inside and out
- Side walls have suction cups for attaching to the vehicle
- Includes practical carry bag and air pump
- Vehicle tie-downs with 5 and 7 mm piping or loops for fixing with tensioning lines.

The motorhome awning with new air technology, only one air hose is required. With external valve. Side walls with doors and windows with curtains provide maximum privacy. Floor only as "frame" under air hoses for quick pitching. Colour: Grey, Anthracite, Lime.

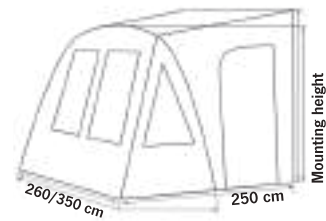

935394 399,-

NEW
2022



Window can be rolled up, incl. mosquito net



PRIVACY ROOM Light

More living space for the F35 PRO with awning retrofit kit

- With Fast Clip fastening system: aluminium profile consisting of two parts into which the side panels can be pulled more quickly Closed, only 120 cm long
- Connection to the vehicle wall by elastic tensioning straps
- Front can be retracted into the awning keder rail
- Front/side sections are connected by zip fasteners
- Door can be retracted on the left or right
- Windows of the front with curtains
- Side windows with mosquito nets
- Incl. Mega Bag light packing bag



Awning retrofit set for F35 Pro

Type	250 VAN	270 VAN	280	310
for awning	F35 (250 cm)	F35 (270 cm)	F35 (270 cm)	F35 (300 cm)
Mounting height	180-220 cm	180-220 cm	240-260 cm	240-260 cm
Weight	8,7 kg	9,1 kg	11,6 kg	11,8 kg
Required accessories			Adapter 434743 (for mounting on F35 270)	Adapter 434743 (for mounting on F35 300)
Art.no.	435638	435639	435636	435637
Price	692,-	695,-	723,-	740,-

Adapter for PrivacyRoom CS Light to F35 Pro

434743 14,30



The small, lightweight awning for vans and mini campers

- Housing in Deep Black or Titanium colour
- Robust, anodised aluminium housing
- Practical roller blind pull-out
- The double channel allows two front parts or accessories to be retracted at the same time
- Lightweight, compact and quick to open and close
- Support feet lie in the awning tube
- Extensive range of accessories

The FIAMMA F35 Pro with a width of 180 cm is ideal for small vehicles. With a weight of only 8.5 kg and a 180 cm extension, it offers a shaded area of 2.9 m²

It can be mounted to almost all roof racks with the specified adapter.

Scope of delivery: awning in housing, pegs and lines for fastening to the ground

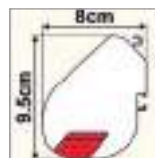

Dimensions

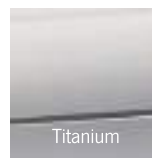

Titanium

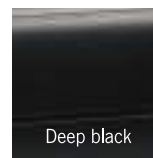

Deep black



Royal Grey



Royal Blue

Cloth colours



Vehicles	F35 PRO - Case Titanium				Royal Grey	Royal Blue	Price
	Wide	Excerpt	Weight	H _{max. front}			
For Caddy KR, Berlingo & Co.	180 cm / 220 cm	180 cm / 225 cm	8,5 kg / 10,5 kg	195 cm / 225 cm	43775 / 43776	43770 / 43771	388,- / 428,-
For vans	250 cm	225 cm	11,5 kg	225 cm	43777	43772	449,-
For vans	270 cm	225 cm	13.0 kg	225 cm	43778	43773	452,-
For vans	300 cm	225 cm	14.0 kg	235 cm	43779	43774	476,-

F35 PRO - Case Deep Black						
	Wide	Excerpt	Weight	H _{max. front}	Royal Grey	Price
For vans	250 cm	225 cm	11,5 kg	225 cm	43780	454,-
For vans	270 cm	225 cm	13.0 kg	225 cm	43781	466,-

You will find suitable vehicle adapters on page 276



Thule Omnistor 4900 complete with mounting adapter

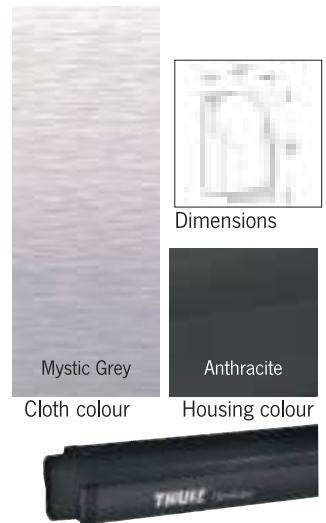

For Ford Custom incl. adapter
Crank awning for Transit/Tourneo Custom



- Awning width 260 cm, extension 200 cm
- Weight 19,7 kg
- Also for buses with pop-up roof
- Screw mounting, awning cannot be removed

Scope of delivery:

Awning 4900 incl. crank and adapter
Housing: Anthracite, Fabric: Mystic grey.

for right side of vehicle	42670 709,-
for left side (UK version)	42671 709,-

For Citroën SpaceTourer incl. adapter
Also for Peugeot Traveller & Toyota ProAce



- Suitable for Pössl Campst
- Vehicle height under 200 cm
- Awning width 260 cm, extension 200 cm
- Weight 21,8 kg
- Awning is removable, screw mounting

Scope of delivery:

Awning 4900 incl. crank and adapter
Housing: Anthracite, Fabric: Mystic grey.

for right side of vehicle	42672 739,-
for left side (UK version)	42673 739,-

For VW T5/T6 incl. adapter
For buses without keder rail or Multirail



- Also for buses with pop-up roof
- Width 260 cm/300 cm, extension 200 cm
- Screw mounting, awning not removable

Scope of delivery:

Awning 4900 incl. crank and adapter
Housing: Anthracite, Fabric: Mystic grey.

For short wheelbase (B 260 cm)

right vehicle side	42674 709,-
left side (UK version)	42675 709,-

For long wheelbase (B 300 cm)

right vehicle side	42676 769,-
left vehicle side (UK version)	42677 769,-



EXCLUSIVE

Thule Rainblocker Set:

consisting of 2x Rainblocker Front XS, 2x Rainblocker Side XS in a high-quality bag

43089	559,-
--------------	--------------



Removable awning with adapter for Reimo Multirail VW T5/T6/T6.1

- Can be quickly and easily removed from the vehicle
- Variants for mounting on the right and left side of the vehicle
- Complete set with Thule awning 4900, mounting adapter, crank handle and sealing rubber
- Total height is not increased with Reimo sleeping roof on the vehicle.

Scope of delivery:

detachable awning 4900 incl. adapter, crank, sealing rubber. Housing: Anthracite,

Thule Omnistor 4900 for short wheelbase

Wide	260 cm		
Excerpt	200 cm		
Weight	17,5kg		
Vers. EU - KR	432080	669,-	
Vers. UK - KR	432081	679,-	

Thule Omnistor 4900 for long wheelbase

Wide	300 cm		
Excerpt	250 cm		
Weight	19,6kg		
Vers. EU - LR	432084	759,-	
Vers. UK - LR	432085	754,-	



Incl. adapter

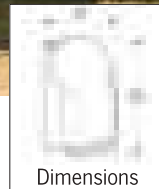

Dimensions



Housing anthracite



Cloth Mystic Grey

Accessories for Omnistor 4900:

REIMO Multirail Page 255

Rain Blocker and Sun Blocker accessories

on page 285

Thule Windscreen

extendable to 300 cm **Windscreen**
height 150 cm **44590 189,-**



The complete awning package - awning + Multirail + VW Bus adapter

- All in one set
- High quality Thule awning TO 4900
- REIMO - Multirail with spoilers front and rear + Adaption for awning

Description and scope of delivery as described above, but including the high-quality rain gutter Multirail for VW Bus T5/T6 KR. The Multirail serves as awning holder. The mounting is done by gluing and screwing

Vers. EU - KR	432086	840,-
Vers. UK - KR	432087	840,-



Scope of delivery:
Multirail
+ adapter
+ awning
= Set for VW Bus T5/T6
(without mounting)



Roof awning F40 van

- Reinforced articulated arms
- Mounting with deep-seated adapters
- Space saving, reduced overhang

Royal grey fabric, Deep black housing. Technical data: Awning width 270 cm, fabric width 257 cm, extension: 225 cm, Weight: 19.0 kg, mounting adapter required.

Awning F40 van **44364** **714,-**

Mounting adapter for F40 van

VW T5 / T6 Transporter and Multivan without C-rail in the roof

- Mounting on existing roof points
- No drilling, no gluing
- Can be removed at any time
- Only for VW without C-rails

2 holders (1 x 20 cm + 1 x 25 cm) Right side of vehicle

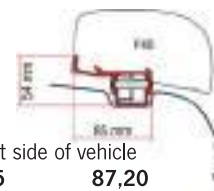

44365 **87,20**

Left vehicle side **UK version** **443651** **87,20**

Sealing tape Rain Guard for F40 van

Sealing between roof and awning

433884 **127,-**

Room Van for VW - Awning for awning F40 van

- No additional poles
- Ripstopmaterial - light and tearproof
- Side parts without window, front with window
- Incl. packing bag

443600 **596,-**



Room Van awning

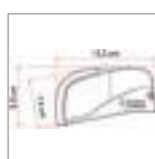

Dimensions

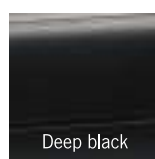

Deep black



Royal Grey

Housing colour

Cloth colour

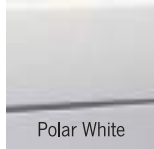

Polar White

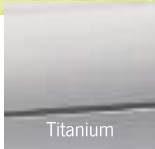

Titanium

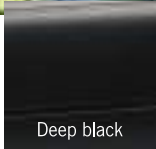

Deep black

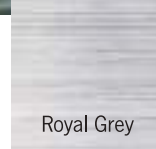

Royal Grey

Housing colour

Cloth colour

Special awning for VW T5 / T6 Multivan and California with VW rails

- With matching adapter and double piping on the front profile
- Awning width 263/308 cm - Extension: 200 cm
- Fabric colour Royal Grey, fabric width 247/292 cm
- Weight: 19.5/22.0 kg

Side wall awning incl. adapter for VW California

For California with sleeping roof and lateral VW keder rail

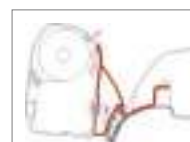

Awning (width 260 cm) for VW California

Housing Polar White **4376709** **698,99**

Titanium housing **4376710** **713,-**

Case Deep Black **4376760** **713,-**

Side wall awning incl. adapter for VW Multivan

For mounting on original VW rail on the roof

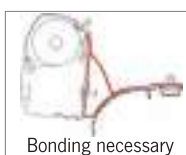

Bonding necessary

Awning (width 260 cm) for VW Multivan KR

Titaniumhousing **4376730** **713,-**

Housing Titanium, UK-Version **4376740** **713,-**

Case Deep Black **4376780** **713,-**

Awning (width 300 cm) for VW Multivan LR

Housing Titanium **E46270** **738,-**

Housing Titanium, UK-Version **4376742** **738,-**



Accessories:

RainGuard sealing rubber closes the gap between awning and vehicle wall

433881 **80,40**

Mounting adapter THULE 3200

Thule 3200



Cloth colour

Housing colours

Dimensions

THULE 3200 - Special awning for vans and camping buses

- Small housing, large extension of 250 cm
- Low height due to design and shape
- Can be rolled out manually - one-man operation
- Fabric tensioning system with ratchet technology
- Quick Lock System for variable height adjustment of the support feet
- Contemporary look, perfect integration on the vehicle

THULE 3200

Wide	190 cm	230 cm	250 cm	270 cm	300 cm
Excerpt	250 cm	250 cm	250 cm	250 cm	250 cm
Weight	12.0 kg	13,8 kg	14,7 kg	15,6 kg	16,9 kg

Housing silver anodized

Uni grey	—	—	42680	42681	42682
Price			479,-	499,-	519,-

Housing Black

Uni grey	42683	42684	42685	42686	42687
Price	449,-	479,-	489,-	509,-	529,-

Scope of delivery:

Awning for manual operation. A vehicle-specific adapter is required for installation (please also order).

Thule Rainblocker Sets T3200

Front set with height 185 cm, Width 250 cm (112+127 cm), 2-piece **430064 219,-**

Front set with height 185 cm, Width 270 cm (112+147 cm), 2-piece **430066 224,-**

Front set with height 185 cm, Width 300 cm (112+181 cm), 2-piece **430067 239,-**



Wall adapter Flat Wall

Also suitable for UK. **42688 35,-**



Roof adapter Roof Rack

Also suitable for UK. **42689 75,-**

VW T5/T6 Fix

For fixed mounting on the VW bus.

42690 99,90
UK 42696 129,-



VW T5/T6 Multirail

For mounting on the REIMO Multirail. short wheelbase

42691 129,-
UK 42697 129,-

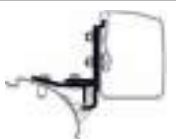

VW T5/T6 Brandrup

For mounting on a Brandrup gutter.

42692 129,-



Citroën Spacetourer

Peugeot Traveller, Toyota Verso and Opel Zafira D.

42693 130,-
UK 42699 129,-



Ford Custom

Fixed mounting on Ford Transit/Tourneo Custom.

42694 129,-
UK 42679 129,-



Renault Traffic

Fixed mounting also on Vivaro/Talento/NV300.

Also suitable for UK. **42695 93,-**

Thule Omnistor 5102



Cloth colour

Housing colours

Dimensions

Special awning VW T5/T6 Transporter or Multivan incl. adapter

- For VW Multivan or Transporter from 2003 onwards
- With 90 cm long crank adapted to the vehicle height
- For flat roof with C-rail on the roof
- Rail can also be retrofitted*

Thule Omnistor 5102 - incl. adapter

Wide	260 cm
Excerpt	200 cm
Weight	19,8 kg
Housing light grey	43207 789,-
Housing anthracite	43208 789,-

Scope of delivery: Awning, 2 adapters for the C-rail (see illustration below). This rail is standard on some models. Not for vehicles with high or sleeping roof



*If original rail VW not available, please obtain from VW dealer.

VW T5 / T6
Screwing to existing points, no gluing. Not for C-rail. 2 holders à 12 cm.
E6413 79,90

VW T5 / T6
For Multivan or Transporter **with roof rail**
Gluing necessary. 2 holders à 12 cm.
43340 76,70

VW T5 / T6
For Multivan/Transporter. **Roof rail gluing** necessary. 2 x 21,5 cm.
433403 86,91
UK 433404 86,91

VW T5 / T6
VW California.
2 holders à 12 cm
433401 78,-

VW T5 / T6
VW bus with Branderup rain gutter
2 holders à 8 cm
433402 72,80

VW T5 / T6/ T6.1
KR with REIMO Multirail rain gutter
2 holders à 8 cm
433405 72,80

Westfalia Kepler
VW T6 LR
for L2, 2 holders à 10 cm.
433406 98,60

VW T4
Adapter setfor flat roof mounting
2 holders à 8 cm
43330 53,60

Also for folding roofs

VW T4
For Brandrup gutters
2 holders à 8 cm.
433201 80,80

Renault Trafic
Until My. 2015
2 holders à 12 cm
433131 68,90

Opel Vivaro
From My. 2015
2 holders à 12 cm
433132 72,99

Mercedes Benz Vito up to My. 2004,
2 holders à 8 cm.
43341 84,20

Mercedes Benz Vito/Viano and V-Class
from 2014, 2 holders à 13 cm. Not with REIMO-SD.
433412 74,90

Mercedes Benz V-Class Marco Polo
from 2014
1 holder à 12 cm and 1 holder à 13 cm
433413 191,-

Westalia
Jules Verne Mercedes Vito
2 holders à 12 cm.
433414 99,-

Kit Nissan NV200/Evalia
For awning br. 220 cm.
2 holders à 8 cm.
433415 86,50

Ford Transit Custom
2 holders à 12 cm
434562 93,50

Dreamer Capland/Capfun
Ford Transit Custom
2 holders à 12 cm.
433416 93,50

Standard
2 holders à 8 cm.
43348 61,20

Kit car for roof rack
2 holders à 8 cm.
43398 72,80

Kit car for roof rack
2 holders à 8 cm.
43398 72,80

F45 Wall mounting adapter for panel vans and buses

Rail
Length 400 cm
E6019 30,20

Wall bracket for smooth, vertical motorhome and caravan walls - Wall bracket series

Kit S 120 Single holder 1 holder à 12 cm +accessories 43481 14,60	Kit S 400 single holder 1 holder à 40 cm + accessories 43482 27,70	AS 300 Complete rail 1 holder, width 300 cm. 43335 148,-
Kit AS 120 holderset 2 holders à 12 cm 1 holder à 8 cm + Accessories Series at 260-400 cm 43480 34,70	Kit AS 400 holderset 2 holders à 40 cm 1 holder 12 cm + accessories Series at 450-500 cm 434821 71,90	AS 350 Complete rail 1 holder, width 350 cm. 433351 168,-
		AS 400 Complete rail 1 holder, width 400 cm. 433352 197,-
		AS450 Complete rail 1 holder, width 450 cm. 433353 245,-

Modular fixings for F45

Ideal for mounting on the high roof

Adapter sets for almost every mounting situation
5 different aluminium profile parts to put together an adapter yourself. The holder parts are 8 cm wide and can be combined with each other (see examples).

T-adapter	43364 12,60
B-adapter	43365 23,80
C-adapter	43367 21,40
D-adapter	43372 10,70
U-adapter	43373 13,40

All 8 cm wide



VW T3
From year '80. With holder for the rain gutter. 2 holders à 8 cm
43312 91,80



VW T5/T6
Bonding necessary. Transporter or Multivan without C-profile. 2 holders each 21.5 cm. Mounting on the vehicle.
right E4631 79,60
left, (UK) E4830 79,60



VW T5/T6/T6.1 KR
With REIMO Multirail rain gutter. Also with sleeping roof.
2 holders à 12 cm
433202 91,59



VW T5/T6
With Brandrup gutter.
2 holders à 12 cm
4440671,-



VW T5/T6
Screwing into the existing mounting points, no gluing necessary. Not for C-rail. 2 holders à 12 cm.
E6413 79,90



VW T4
With Brandrup gutter or REIMO Multirail
2 holders à 14 cm
433201 80,80



VW T4
For flat and sleeping roof
For screwing. 2 holders à 14 cm
43310 93,50

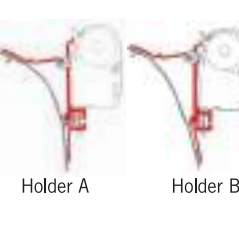

Holder A Holder B
For vans with rain gutter
In set with bracket A + B. Consisting of 2 holders à 8 cm
43311 114,-



Traffic/Vivaro < 2015
For long wheelbase with awning F45 S 260
2 holders à 16 cm
43313 72,80



Renault Trafic, Opel Vivaro, Fiat Talento from 2015
2 holders à 16 cm
433133 76,51



Westfalia high roofs
For Westfalia high roofs with awning preparation.
2 holders à 12 cm
43483 35,70



GFK roofs
For gluing. Especially for high roofs of Mercedes, VW, Renault + Opel, 2 holders à 40 cm
43460 98,60

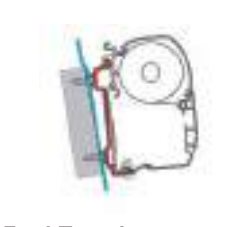

Ford Transit
Ford Transit from 7/06 with standard high roof.
2 holders à 40 cm
43456 72,99

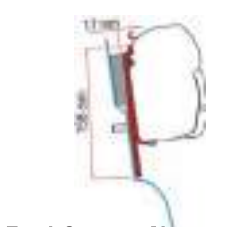

Ford Custom Nugget
Ford Custom Nugget with high roof.
2 holders à 12 cm
434561 101,99

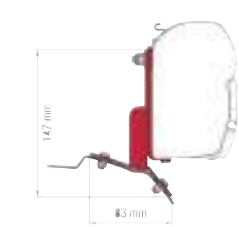

Ford Custom
Ford Custom.
2 holders à 12 cm
45301 101,99



Ducato/Boxer/Jumper
From year of manufacture 1994 to 6/06 for standard high roof, 2 brackets 8 cm each, Bonding necessary.
43324 69,90



Ducato/Boxer/Jumper
From 7/06 for standard high roof H2, 2 holders 8 cm each
Bonding necessary
43316 72,90



Ducato/Boxer/Jumper
From 7/06 for standard high roof H2 with Roof Rail, 3 holders of 12 cm each
44405 69,70



Ducato/Boxer/Jumper
From 7/06 with Roof Rack, 3 holders à 12 cm
43355 64,-



Ducato/Boxer/Jumper HymerCar and Pössl
For vehicles from year of manufacture 07 with standard high roof H2 and folding sleeping roof. 3 holders à 12 cm
444051 156,-



Also for VW LT until 06 and Fiat Ducato until 94 suitable
Sprinter until 06
For Sprinter with year of construction up to 6/06. With holder for the rain gutter. 2 holders à 8 cm
43311 114,-



Sprinter / Crafter
From 7/06 with high roof.
2 holders à 40 cm
43456 72,99



Sprinter / Crafter
From model year 7/06 with high roof H3. Also for Westfalia high roof H3.3 holders à 8 cm
43477 76,51



Mercedes Vito
With original Mercedes roof rack.
2 holders à 14 cm
43317 118,-

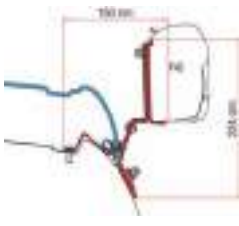

Mercedes Marco Polo
Mercedes Marco Polo from 2014. 1 holder à 12 cm and 2 holders à 13 cm
433413 191,-



EXCLUSIVE

Carry-Bike VW T6 Reimo Deep Black

- Suitable for transporting 4 wheels
- Colour Deep Black
- Rail Premium

The rack is suitable for up to 4 bikes (i.e. telescopic support bar), but is equipped as standard for the transport of 2 bikes.

416,--
440223
416,--



① 440219 VW T5

532,--





② 440221 VW T6

607,--

Volkswagen Carry Bike VW T5 and T6 Pro

- Elegant design, adapted to the vehicle lines
- Easy operation of the tailgate

For 2 bicycles (maximum 4 wheels) For mounting on the tailgate. Sturdy, functional and easy to handle. Shock absorber to absorb shocks and vibrations while driving. Optimal attachment of the wheels by means of precisely fitting locking blocks and quick straps. The frame is extendable for a maximum of 4 wheels. With Bike Block S Pro D1 and S D2spacers

2 rails Premium 128 cm

①	Carry Bike Pro VW T5 tailgate, silver bikes	Weight: 14 kg, for 2 to max. 4 bikes	440219	532,--
②	CarryBike Pro VW T6 tailgate, black	Weight: 14 kg, for 2 to max. 4 bikes	440221	607,--
③	VW T6 (also with raised roof)* silver bikes	Weight: 8,3 kg, for 2 to max. 4 bikes	440222	354,--

Zubehör für 3. bzw. 4. Rad

3.	Fahrradschiene Rail Premium S		440690	82,80
4.	Fahrradschiene Kit Rail Premium 48			
	2-teilige Schiene für VW T5/T6 Pro silver		440692	50,50
	2-teilige Schiene für VW T6 Deep Black		440695	62,70
	Bike Block D2 sw		441364	32,80
	Bike Block D3 sw		441363	35,40

Conversion kit for bike carrier Carry Bike + Carry Bike Pro With these adapters the T5 carrier + Pro can be converted for the T6

④	for T		440723	153,--
⑤	for T6		440230	136,--

Carry-Bike bicycle carrier

① **VW T5 Bus Year of construction 2003 to 2015** Secure bicycle fastening by Rail Quick quick-release fastener with Support on the bumper. For 2 wheels due to extendable frame for max. 4 wheels. Scope of delivery: 2 Rail Quick 128 cm and 1x Bike Block Pro 1 + 1x Pro D 2. for mounting on the tailgate Load capacity 60 kg, weight 8,3 kg

Carry Bike VW T5	440210	336,-
Rail for 3rd or 4th wheel	44426	37,40

② **VW Transporter year 2003 to 2015** with Premium bike rails. Basic equipment for 2 wheels. Extendable up to 3 wheels. Optimal and safe fastening of the wheels by accurately fitting locking blocks for the bicycle rims and quick straps. Mounting without drilling. Max. Max. load 50 kg, weight 9,2kg.

Carry Bike	440700	359,-
Premium rail 3rd wheel	44426	37,40

③ **VW Bus year of construction 1991 to 2003** Inexpensive bicycle carrier for 2 wheels (maximum 3 wheels) for mounting on the tailgate with 2 rails Rail Quick 128 cm and Bike Block 1+3. load capacity 50 kg weight 7,4 kg

Carry Bike VW T4	44500	243,-
-------------------------	--------------	--------------

VW Bus My. 1991 to 1996

Very stable with bumper support for 2 wheels (maximum 4 wheels) For mounting on the tailgate with 2 rails Rail Quick 128 cm and Bike Block 1+3. Load capacity 60 kg. Weight 8,3 kg

Carry Bike VW T3	440840	318,-
Rail for 3rd wheel	44426	37,40

⑤ **VW Bus "Bulli" until 1990** For 2 bicycles (max. 3 wheels). For mounting on the tailgate. 2 rails Rail Quick 128 cm. Load capacity 50 kg, weight 6,5 kg

Carry Bike VW "Bulli"	440693	277,-
------------------------------	---------------	--------------

⑥ **Ford Transit / Tourneo Custom** Secure bicycle transport thanks to special holder. Adapts perfectly to the contours of the vehicle. Secure bicycle fastening with sturdy Rail-Quick quick-release fasteners. For mounting on the tailgate, basic equipment for 2 bikes. Can be extended up to 3 wheels. With bike block. Max. Max. load 50 kg, Weight 8.5 kg.

440679	400,99
---------------	---------------

⑦ **Traffic, Vivaro and Primastar** for tailgate. For 2 wheels. Can be extended to 4 wheels. Mounting without drilling. With Rail-Quick bicycle rail. Load capacity 60 kg

440332	377,-
---------------	--------------

⑧ **Mercedes Benz Vito from 2003 / Viano** for 2 wheels. Extendable to 4 wheels. Mounting without drilling. With Rail-Quick bicycle rail. Load capacity 60 kg

440871	527,-
---------------	--------------

Bike Block for number ① to ⑧

44132	17,30
--------------	--------------

Additional rail for Nr ⑥ to ⑧

44426	37,40
--------------	--------------

⑨ **Bicycle cover** No soiling while riding. Protection against the weather. Bikes are completely wrapped. Backside is closed with velcro. No inflation during the ride. Flexible due to adjustable straps. Made of extra strong nylon.

Colour: Platinum. For 4 wheels.	44470	51,71
---------------------------------	--------------	--------------

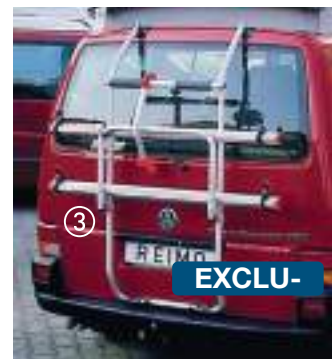

With sewn-in pocket for warning signs



Multi and Multi Dark- Universal tables for campers

- Extremely small pack size, ideal for small camping vehicles
- Loadable up to 30 kg

Table top: 90 x 60 cm, table height: 74 cm. Pack size: L x W x H 90 x 60 x 5 cm. Weight: approx. 6.6 kg.

Multi, colour light grey	910537	83,99
Multi Dark, colour dark grey/black	910527	87,99



Luxury - Folding camping table with living feeling

- Noble wood design
- Especially suitable for minicampers and vans
- Three different heights adjustable
- Table top divided into 3 parts for small pack size
- Practical carry bag included

For 2-4 persons. Dimensions: 100 x 70 cm, table height: 44/60/70 cm. Load capacity: 30 kg. Pack size: 100 x 64 x 25 cm. Weight: approx. 5.5 kg **9105498 139,-**



Duo Classic with height adjustable feet

- Height adjustable feet
- Extra flat scissors for more leg-room
- Small pack size

Aluminium roll table with height-adjustable feet. Table surface: W 70 x 70 cm, table height: 69 cm, load capacity: 30 kg. Pack size: Ø 15, length 72 cm. Weight: 4.5 kg.

910201	49,90
---------------	--------------

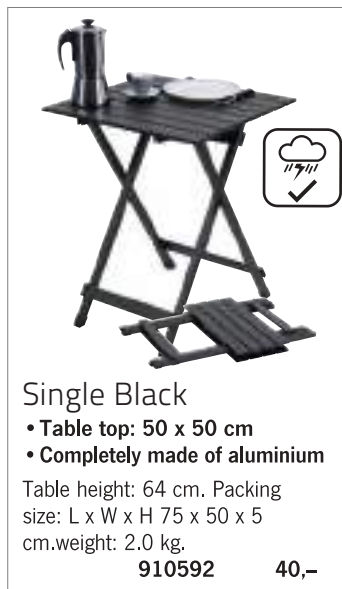

Single Black

- Table top: 50 x 50 cm
- Completely made of aluminium

Table height: 64 cm. Packing size: L x W x H 75 x 50 x 5 cm. weight: 2.0 kg.

910592	40,-
---------------	-------------



Big Butler

- MDF table top: 60 x 40 cm
- Only 1,6 kg light

Table height: 65 cm. Pack size: L x W x H 80 x 60 x 6 cm.

91060	36,99
--------------	--------------



Lightweight camping table Tyresta - Table tops in trendy wood look

- Weatherproof table top with noble wood decor
- Plate feet prevent sinking in, loadable up to 80 kg
- Quickly height-adjustable with a handle, 59-72 cm

Table top: 100 x 68 cm made of PP honeycomb, glass fibre and resin. For 2-4 persons. Weight: 4,3 kg. Packing size: 100 x 68 x 6 cm.

910574	109,-
---------------	--------------



Director's chair Maxi

- Black aluminium frame
- With practical side table

Seat W46 x D38 cm, seat height 46 cm, total height 87 cm, loadable up to 100 kg, pack size: 85 x 50 x 17 cm, weight approx. 3,4 kg
961004 49,99



Folding chair Bungee - pure relaxation

- With rubber lacing and high backrest
- Very comfortable thanks to elastic lacing

Colour black, with 2 cords in peppy lime green or classic black, cords easily replaceable by yourself. With locking lever. Max. load approx. 120 kg. Dimensions 81 x 71 x 99 cm, flat packing size: 10 x 71 x 104 cm, weight: approx. 4,2 kg

910836 64,99



Toscana Luxury

Seat surface: W 56 x 56 cm, seat height: 47 cm, backrest: 25 cm, total height: 81 cm, load capacity: 100 kg, aluminium frame, pack size: Ø 27 x H 94 cm, fits the VW tail-gate bag. Weight: 2,0 kg. Material: 100% polyester. Colour: black
910971 59,99



Folding chair Salamanca

- Comfortable straight seat
- With practical drink holder
- Extra wide feet

W 65 x D 60 x H 90 cm, seat W 48 x D 50 cm, seat height 45 cm, backrest 50 cm. Loadable up to 100kg. Packing size approx. 100 x 24 x 23cm. Weight: 4,8 kg
 Colour: Anthracite/Lime

92047 44,90



La Palma

With fixed armrests. Backrest multiple adjustable. Bottle holder. Frame in aluminium. Cover: 100% polyester. Seat surface: W 53 x D 46 cm, seat height: 50 cm, backrest: 68 cm, total height: 98 cm, load capacity: 120 kg, pack size: (LxWxD): 97x30x21 cm, weight: 4,8 kg. Black

92030 67,98



Campfire - Enamel tableware set

- 6 pieces, for 2 persons
- Cult enamel tableware with long life
- Very light and unbreakable

Crockery set consists of
 2 dinner plates Ø 25,5 cm, height 2 cm
 2 bowls Ø 15,5 cm, height 6 cm, 550 ml
 2 mug Ø 8 cm, height 8 cm, 350 ml Not suitable for the microwave. Dishwasher safe at low temperature. Weight: 1,2 kg **930968 29,99**



FITTING:

Stainless steel wine goblet, approx. 230 ml
 Stainless steel is especially food safe and easy to clean. Ø Top 6,3/Bottom 5,7 x H 14,5 cm
set of 2 930938 14,99



2 in 1 silicone bowl and sieve

Foldable silicone bowl incl. foldable silicone strainer, each with 2 handles. When stacked and folded, the bowl with strainer can be stored in the motorhome or caravan to save space. Dimensions: bowl: 25.6x20x5.6/11 cm, colander: 24x19x4.8/10 cm, weight approx. 0.5 kg. Packing size: 26x20x6 cm
Anthracite/Lime 94108 14,99



Camp4 Silicone Folding Kettle

Stainless steel bottom suitable for gas & stove top. Attention: Always remove kettle from stove with heat protection! Capacity approx. 0.8 l. Dimensions: Ø 13 cm, H 5,5/13,5 cm. Weight 0,3kg.
940850 18,99



Foldable silicone coffee filter

- Small pack size
- With stainless steel filter insert: no paper filter necessary

Dimensions: Ø 11,5 x H 1,5/8,5 cm **940846 9,98**



Flextrash bin

- Made from recycled PET bottles
- Washable

Practical trash can with many mounting options.

① 3 litres **9156292 22,96**
 ② 5 **9156291 27,95**
 ③ 9 lit **915629 32,95**

④ **Flipclips for headrest**
 Simply attaches to the metal headrests of your car
915621 7,45

⑤ **Table holder** Suitable for all tables between 0,5 and 4 cm.
915653 7,95

⑥ **Tubeclips**
 For 20 to 30 mm thick tubes. Includes strap with Velcro fastener.
9156533 5,95

⑦ **Campstick** 75 to 90 cm with storage bag
9156531 11,95

⑧ **Vacuclip** 3M folding suction cup for easy attachment to smooth surfaces
9156532 7,95

⑨ **Flextrash bin liners** Package contains 10 bin liners
 3 litres **9156295 4,75**
 5 litres **9156294 4,75**
 9 litres **9156293 9,95**





Cook'n'Fold - Cartridge cooker with folding feet and ignition safety device



- For screw cartridge
- Space-saving with retractable / extendable feet
- With ignition fuse
- Incl. practical storage case

Nominal heat load 2,4kW/Hs, gas consumption 175g/h, dimensions: W30 x D22,5 x H12/23cm, weight: 1,8kg
706622 64,99

Suitable gas cartridge from Coleman: Performance C500, 440g gas
942580 8,98



Skotti Grill
stainless steel

- Light & handy
- Fast & safe
- High quality & clean

Skotti weighs only 3 kg including the bag and fits flat into a 25 l backpack. It can be assembled and disassembled in just 1 minute and is extremely safe and stable. Skotti is made of stainless steel, a clean solution for the environment and easy to clean.

914459 159,-

SmartSpace Stackable Pot Set
10 pieces

Practical square aluminium pot set with matching stainless steel lids. The silicone mats in the respective pot size serve as trivets or protection from damage when stacking. The revolutionary handle is removed or secured with the simple push of a button.

10-piece set consisting of: 1 x 1,5 l pot: W 16.2 x L 16.2 x H 10.6 cm
 1 x 2,0 l pot: W 18,5 x L 18,5 x H 12,4 cm
 1 x 3,0 l pot: W 21 x L 21 x H 14 cm
 3 x matching stainless steel lids
 1 x removable handle
 3 x silicone mats as coasters
 Weight 3,3 kg
 Colour: Grey

92192 199,-

Camper Vans TESTSIEGER 1/21
 PREMIUM PRODUCT

Elite - 5-piece aluminium pot set - Ideal for van campers

- Made of high quality aluminium - very light
- Fill quantity indicator in the pot
- Foldable & lockable handles
- Stackable into each other to save space, incl. carrying bag

Set Elite for 1-2 persons, consisting of:
 1 pot with lid Ø approx. 16 cm, 1,7 l, 1 pot with lid Ø a. 18 cm, 2,7 l
 1 pan Ø approx. 19 cm, 1 l Thanks to the fold-down handles, the pot set can be stored in a very space-saving way.
 Colour of pot: Anthracite, colour of handle: Lime
 Weight approx. 0.8 kg **92303 59,99**

Set Elite L for 2-4 persons, consisting of:
 1 pot with lid Ø approx. 19.5 cm, 2,7 l, 1 pot with lid Ø approx. 21 cm, 4,2 l, 1 pan Ø approx. 22 cm, 1,5 l weight approx. 1.2 kg
923031 70,-

For 1-2 persons
For 2-4 persons

Incl. transport bag
 Compact storage



Camp4
OUTDOOR FASCINATION

65
LITERALLY

45
LITERALLY

30
LITERALLY

Storage boxes with lid and wheels

The boxes are foldable and with the fixing brackets the lid holds firmly on the box. With 4 wheels. Material: TPR/PP.

Large S: capacity 30 litres, dimensions: L 54.5 x W 40 x H9.6/27.5 cm, colour: grey with lime **940292 19,99**

Large M: Capacity 45 litres, Dimensions: L 61 x W 45 x H 10/30.4 cm, Colour: Grey with Petrol **940293 24,99**

Large L: capacity 65 litres, dimensions: L 72 x W 53 x H 10/31 cm, Colour: white with grey **940294 29,99**

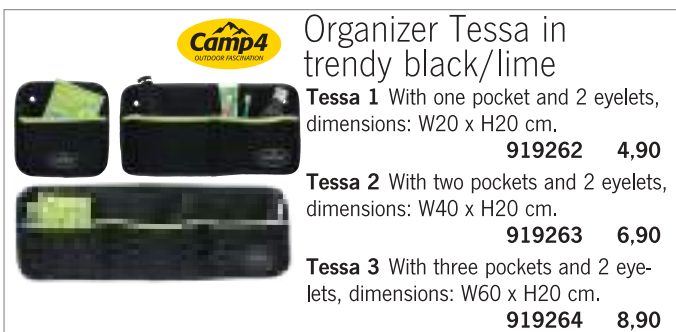

Camp4
OUTDOOR FASCINATION

Organizer Tessa in trendy black/lime

Tessa 1 With one pocket and 2 eyelets, dimensions: W20 x H20 cm. **919262 4,90**

Tessa 2 With two pockets and 2 eyelets, dimensions: W40 x H20 cm. **919263 6,90**

Tessa 3 With three pockets and 2 eyelets, dimensions: W60 x H20 cm. **919264 8,90**



Bag for tailgate VW T5/T6

- For VW T5/T6 station wagon tailgate (with hard fibre cladding)
- For mounting on the tailgate (screws included)
- Suitable for 2 folding chairs Toscana Luxus, item no.: 910971
- With Velcro strap securing for the chairs
- Material: robust imitation leather

Right and left version, depending on the position of the furniture row

For left-hand drive vehicle	11001	98,27
For right-hand drive vehicle	11001R	93,10

Utensilo set for passenger seat



- 2 or 3 pockets with holdingmat for the back of the FH seats
- The pockets are firmly sewn to the
- Fastening by means of metal eyelets on the seats
- e.g. for VW T5/6, MB Vito as of 2014

Utensilo passenger seat with 3 pockets

consisting of: 1x bag (36 x 20 x 5cm) and 2x bags with mesh pocket (45 x 25 x 6cm)

919165 189,-

Bag for passenger seat

- Retaining mat with 4 pockets for driver and passenger seat-Backside
- Secure hold thanks to fastening with 6 slots (on headrest) and 2 elastic bands with hooks
- Chic imitation leather look in the colours black and grey

Holding mat with 4 firmly attached pockets. Dimensions: 1x 32 x 20 cm, 2x 21 x 19 cm, 1x 44 x 28 cm. Pockets are closed by Velcro. Colour black/grey. Weight approx. 0,8 kg.

919167 34,90





①

②



CARBEST
INNOVATIONS FOR MOBILE LIFE



Set of 2 ramp wedges and optional blocking wedges

<p>① Compensating wedges made of HDPE plastic, load capacity: 5t, dimensions: L 43 x W 19 x H 9 mm colour: yellow, set of 2</p>	93125	18,99
<p>② Matching blocking wedge, dimensions: 13 x 8,5 x 9 cm. Colour: Yellow, set of 2</p>	93126	5,95

<p>Step wedge XL</p> <p>2x Multi-level ramps/step wedges are ideal for levelling caravans or motorhomes on uneven ground. Ramp size: 61x21.5x12cm, Material: PP 2150 g, Load capacity: 5t Colour: grey, set of 2</p>	912554	23,99
---	---------------	--------------



①



②

Step wedges Level Up with 3 approach levels

- Wide support for supporting the motorhome
- Non-slip surface that adheres to the tyre
- Lightweight, corrosion-free, quick to clean
- UV-resistant

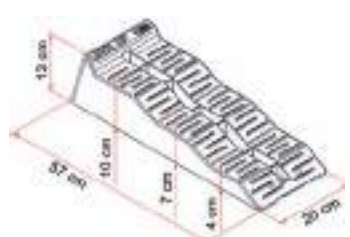

<p>① Level up step wedge, load capacity 5 t per axle Dimensions: 57x20x13 cm, pair</p>	912394	25,80
<p>② Kit Level up, 2 step wedges Level up in practical bag Dimensions: 57x20x13 cm</p>	912395	34,70

BEST
SELLER



H: 15 cm

55 cm

19,5 cm

THULE

Drive-on wedges

Load capacity up to 5 t per axle

Set with 2 ramp wedges and sturdy carrying bag. Three different height levels for easy levelling of the motorhome

Per pair	912521	33,-
----------	---------------	-------------

Leveling wedges - Lightweight, resistant, TÜV-tested

- Tyre-friendly surface with good grip
- Stackable with self-locking latch
- Lightweight, corrosion-free, quick to clean
- UV-resistant



Level Pro, load capacity 5 t per axle
weight 0,8 kg/wedge, dimensions: 43x17x9 cm

pair	93106	16,51
------	--------------	--------------

CARBEST
INNOVATIONS FOR MOBILE LIFE



Use horizontal & vertical



Retaining clip opens up to 105 mm wide

Universal tablet / mobile phone holder
For maximum width of approx. 10-17.7 cm, 360° rotatable, for headrest, bicycle, tent pole etc. For tubes with Ø 18-34 mm
462381 29,99

Universal Navi- and Mobile Phone Holder
With suction cup fastening, 360° rotatable, material: ABS+PU, colour black, dimensions: 12x10x7,5cm
46238 5,99



Induction charging cradle for Fiat Ducato, Peugeot Boxer and Citroën Jumper

- Is integrated precisely into the vehicle cockpit
- For wireless charging of all smartphones that allow inductive charging

Insert smartphone and charge wirelessly. The charging process can be controlled via the integrated on/off switch. The lockable cover prevents the mobile phone from slipping out or out of place. Fast and uncomplicated installation: The original holder is simply exchanged for the charging cradle and connected to the vehicle's electrical system via Plug & Play. All connection cables included

2 further connections for additional devices are built into the charging cradle.

Charging cradle with USB and HDMI connection 81763 155,10
Charging cradle with USB and jack/AUX connection 81764 155,10



Felt seat organizer

- For driver or passenger seat
- With retaining strap on armrests and hooks for fastening under the seat
- Large bag also suitable for laptop

Material felt, colour anthracite Dimensions: W42 x H76 cm.
919172 19,90

CUP-IN Cupholder for VW T5/T6 + Mercedes V-Class



Cup-In for armrests. Can be attached to armrests in the vehicle without tools. Stable due to ceramic-coated metal (matt titanium colour) combined with black polyamide. Optimal for containers with Ø 65 - 80 mm and minimum height 95 mm

① **For wide armrests:** Not suitable for original armrests on VW commercial vehicles year of construction from 5/2003 or 2015. dimensions: 88 x 165 x 96 mm. Weight 220 g. 1 piece
46220 30,99

② **For narrow armrests:** with a minimum height of 45 mm and a maximum width of 58 mm. Optimal on armrests of VW T5/T6 seats or e.g. Mercedes Viano. 1 piece
46206 30,99

Robust rubber mats for driver's cab, colour black



Easy to clean

Fig.: Fiat Ducato/Peugeot/ Citroën Jumper, year 2002-2006

2-pcs. for VW Caddy 2008-2020	516802	65,90
3-pcs. for Spacetourer/Citroën Jumpy/ Peugeot Traveller as of 2016	516800	65,90
2-pcs. for VW T4 until 2003	516803	65,90
2-pcs. for VW T5 (2003-2010)	516804	65,90
3-pcs. for VW T5 (2010-2015)/ VW T6 and VW Multivan from 2015 onwards	516805	65,90
2-pcs. for Renault Trafic/Opel Vivaro from 2014/ Fiat Talento from 2016	516801	69,-
1-piece for Ducato/Boxer/Jumper: as of 7/2006	51681	67,-
2002-2006	51680	65,90
3-pcs. for Sprinter/VW LT/Crafter from Bj. 5/2006 onwards	51683	69,90
3-pcs. Ford Custom from year 2013	78098	69,90

Basic - needlefelt carpet	Plus - needlefelt velour with a great look	Luxury - Durable velour	Exquisite - high quality velour carpet
<ul style="list-style-type: none"> ▪ Back with non-slip plastic structure ▪ Edges edged - no fraying ▪ Colour: anthracite mottled 	<ul style="list-style-type: none"> ▪ With practical heel protectors under the pedals ▪ Edges edged - no fraying possible ▪ Backside with non-slip rubber granulate ▪ Colour: anthracite mottled ▪ Easy to clean 	<ul style="list-style-type: none"> ▪ Soft homely surface ▪ Creates a cosy atmosphere ▪ With heel protector ▪ Non-slip rubber back ▪ Colour: anthracite mottled ▪ 100 % polypropylene ▪ Particularly easy to clean 	<ul style="list-style-type: none"> ▪ PU back coating - for even more insulation ▪ Protects the interior perfectly from moisture and contamination ▪ High-quality edging ▪ Non-slip rubber back ▪ Colour: anthracite mottled ▪ Dense rubber (+/-1) ▪ Easy to clean
 <p>①</p> <p>from 27,41</p>	 <p>② + ③</p> <p>from 29,99</p>	 <p>④</p> <p>from 29,99</p>	 <p>⑤</p> <p>from 29,99</p>
<p>Fig: Fiat Ducato, quality Exquisit</p>	<p>Fig: Volkswagen Commercial Vehicle, Quality Plus</p>	<p>Fig: Sprinter</p>	<p>Fig: Ford Transit from 4/2006 Handbrake middle</p>

CARBEST
INNOVATIONS FOR MOBILE LIFE

Cab mats in 4 quality levels

① Fiat Ducato/PeugeotBoxer/CitroënJumper				④ Sprinter/VW LT/Crafter			
from 2015	Basic needle fleece	51674	27,41	from 5/2006	Basic needlefelt	51634	29,99
from 7/2007	Exquisit velour carpet	516051	79,90	from 5/2006	Exquisit Velour carpet	51606	79,90
from 7/2007	Plus Needle fleece velour, grey-mottled	515711	39,90	5/2000-4/2006	Exquisit velour carpet	51602	79,90
from 7/2006	Basic needlefelt	51673	29,99	Renault Trafic (without picture)			
from 2002-2006	Basic needle fleece	51622	29,99	from year 2014	Plus needlefelt velour	51581	38,90
from 2002-2006	Plus needlefelt velours	51567	39,90	Mercedes Vito (without picture)			
from 1994-2002	Plus needlefelt velours	51561	39,90	from 2014	Basic needlefelt	516341	29,99
② VW T4				from 2014	Exquisit Velour carpet	516021	79,90
from 9/1995	Basic needle fleece, multi-piece	51625	29,99	⑤ Ford Transit			
from 9/1995	Plus needlefelt velours	51557	38,90	from 4/2006	Basic handbrakeleft	516351	29,99
③ VW T5				from 4/2006	Plus handbrakeleft	515731	46,90
from 2003	Basic needlefelt	51626	29,99	from 4/2006	Luxury handbrakeleft	516081	59,90
from 2003	Plus needlefelt velours	51568	39,90	2004-2006	Basic needle fleece	51629	29,99
VW T6 (without picture)				Ford Transit Custom (without picture)			
from 7/2015	Basic needlefelt	51578	29,99	from 1/2013	Basic needle fleece	516352	29,99
from 7/2015	Plus needlefelt velour	51579	39,90				

Our dimensions are matched to 2 single seats in the cab . They do not fit with double seats. The mats are 1 or more parts and in this case connected with Velcro

CARBEST
INNOVATIONS FOR MOBILE LIFE

Cab carpet for VW T6 Multi-van

- 1-piece carpet for driver's cab
- Quality: Premium TPO Tuftvelour
- With binding tape

Luxury finish black (Tuftvelour 920g/m²) 515821 159,-



The exclusive HOLIDAY TRAVEL SERIES for true camper fans!



Hooks and towel rails - Imitation leather series with suction cups

① Towel rail with 2 suction cups
600 x 60 x 119 mm, material: imitation leather, aluminium, bamboo

66553 29,99

② 2 hooks with suction cup
53 x 38 x 124 mm, material: imitation leather, aluminium, stainless steel

66552 15,99

③ Towel/toilet roll holder with suction cup

197 x 61 x 179 mm, material: imitation leather, aluminium, stainless steel

66554 24,99

④ Hand brush and dustpan set

The high-quality set consists of a hand brush with bamboo handle and loop and a metal dustpan with hole for hanging up in black.

Dimensions: hand brush L 17 x W 14 cm, dustpan: 33 x 21 cm, packing size: L 33 x W 21 x H 7,5 cm. Weight approx. 0,2 kg

915981 6,99

⑤ Coconut doormat, 50x25 cm

Keeps campers and motorhomes clean. Robust doormat for indoor use.

Material: 100% coconut, dimensions: 50 x 25 cm.

51657 8,09

⑥ Leather barbecue apron

Made of high quality leather with 2 pockets and adjustable straps.

Brown 955192 64,99

Black 955193 64,99

⑦ Charcoal suitcase grill

Assembled in a few seconds. Space-saving storage in the stainless steel case. Attractive and functional - the new folding barbecue from Holiday Travel. Simply open the case and the barbecue is ready to use. The grate can be folded to the side for filling with charcoal. Grate size: 33 x 20 cm.

Case closed approx. 37 x 24 x 8 cm. Weight 2,5 kg.

916881 64,99



① Melamine tableware set Holiday Travel

Premium quality, 8 pieces for 2 persons
Dishwasher safe
2 dinner plates Ø 25,5 cm
2 soup plates Ø 13/20 cm, height 4 cm
2 dessert plates Ø 20 cm
Weight approx. 1,7 kg
917924 34,95

② PLA tableware set Holiday Travel

Made from renewable raw materials
8 pieces for 2 persons
2 dinner plates Ø 25,5 cm
2 soup plates Ø 21 cm, height 3,5 cm
2 dessert plates Ø 21,5 cm
2 mugs, 350 ml,
Ø 8,5 cm height 10 cm
Suitable for dishwasher & microwave.
917991 39,95

③ Key West SAN Glasses Set

2 high quality glasses in a set with coloured bottom
Each 350 ml volume. Printed on one side
Dimensions: Ø 7 cm, H: 9 cm
929080 9,95

Enamel mug single

Large enamel mug, 500 ml volume
Printed on both sides. Ø 10 cm, H 9 cm

④ Boston Black 930965 6,95

⑤ Bay City Enamel Mug Set

2 enamel mugs in a set, 1 x white and
1 x blue, printed on both sides
Each 400 ml volume
Dimensions: Ø 9 cm, H: 8 cm
930964 12,-

Vacuum mug with lid

Capacity: approx. 550 ml, dimensions: H 16
cm, Ø 6.7/9.2 cm, weight approx. 0.25 kg,
double-walled, with transparent lid.

⑥ Dark blue 930954 17,95

⑦ With imitation leather 930953 19,94



The exclusive HOLIDAY TRAVEL SERIES for true camper fans!



① Folding Chair Holiday Travel

For beach, low tables, children. Space-saving folding chair, with noble beech wood Frame: beech wood, cover: polyester blue mottled Seat height: 37cm, seat: W48 x D33cm, load capacity: 120 kg, dimensions: W57 x H76 x D55cm Packing size folded: W57 x H68 x D7,5 cm, packing size folded: 78 x 28 cm. Weight: approx. 3.6 kg

920318 94,99

② Poncho blanket

With 35 cm opening in the middle to pull the blanket over your head as a poncho. Outer material: 210T polyester ripstop, lining: 100% cotton brushed with flannell, filling: 180g/m² silk-like cotton. In a practical pack sack. Dimensions: 155 x 220 cm, weight approx. 1,2 kg

99237 40,-

③ Backpack for every occasion

Trendy color combination of gray mottled and black front pocket with zipper. Softly lined laptop compartment and padded shoulder straps and back. Straps with magnetic closures and adjustable straps. Dimensions approx.H 48 x W 27 x D 14 cm, weight approx. 0,9 kg

92466 24,89

④ Sleeping bag

Can be used as a blanket thanks to zipper, with additional wind protection in the inner part. Extra soft material, outer material: 210T polyester, lining: 100% cotton, filling: 175 g/m² silk-like cotton. Incl. practical pack sack Colour: grey/dark blue, Size: 210 x 90 cm

99236 55,-

New Bone China coffee cups

volume approx. 340 ml, material: New Bone China.

⑤ Holiday Travel **95804 5,99**

⑥ Camper On Tour **95801 5,99**

⑦ Vacuum bottle Keeps hot drinks hot for a long time and cold drinks cold for a long time. Volume 500 ml, material: stainless steel 304. colour: matt white

930952 20,-

⑧ Coffee mug, set of 2

The perfect complement to the vacuum flask. Volume 220 ml each, material: stainless steel. Colour: matt white and matt dark blue

930951 25,-

⑨ Thermo coffee mug

For all drinks that need to stay hot or cold Also ideal for instant noodle soup and similar dishes. Volume 450 ml. Material stainless steel 304 **929916 18,99**

**2^{he}
SET**



① **LED light**

- Noble design due to the materials bamboo, metal and plastic
- With ring and handle for carrying and hanging
- Dimmable and can be used as a power bank

USB charging cable included. Lithium battery 3.7 V, 5000 mAh.

Power: 3,2 W, 180 Lumen

Charging time: 7 h Weight: 0,75 kg

Dimensions: Ø 13 cm Height 25/32 cm

834873 49,99



②

Touch function



③

200x80cm



② **Lancaster design LED lamp**

Elegant design LED lamp with rechargeable battery. Infinitely dimmable via switch or lamp cover (touch function). Incl. 12 V and 230 V charging adapter. Colour white. Dimensions: Ø 75/90 mm, height 170 mm

83496 19,99

Microfibre beach towels, 200x80 cm

Extra large for holidays and home. With sewn-on "hood" to put over camping chairs and loungers (prevents the towel from slipping).

③ **Motif Cannon Beach**

92481 12,50

④ **Bamboo table for 2-4 persons** Small pack size, ideal for mini campers + vans, height adjustable from 42-65 cm. Frame: aluminium, table top: bamboo, foldable, load capacity: 30 kg. In practical carrying bag. Dimensions: 100 x 65 cm, packing size: 100 x 11 cm, weight approx. 6.5kg

9105491 124,90

Dimensions: 80 x 60 cm. Packing size: 80 x 10 x 17 cm. Weight: approx. 5,5 kg.

910573 100,-



100 x 65 cm

Now also in compact size 80 x 60 cm



⑤ **Trendy aluminium folding chair Joplin**

Exclusive, grey mottled fabric, leather leather badge on the backrest. Armrests made of dark real wood. Backrest 4-fold adjustable. Dimensions when set up: WxDxH 60 x 68 x 102 cm Seat: W48 x D45 x H42 cm, backrest: H 67cm. Pack size: 90x28x15 cm, weight: 4,8 kg

920311 74,99

⑥ **Joplin Luxus with 5 mm padding** Pack size: approx. 91 x 28 x 17 cm. Weight: 5,3kg

920314 100,-

⑦ **Footrest/stool**

Matches the folding chair JOPLIN. colour: mottled grey, dimensions: 38 x 38 cm, height 42 cm, packing size: 12 x 12 x 61 cm, max. load up to 70 kg

920312 29,99



⑥

⑦



Relax in style and comfort with the HOLIDAY TRAVEL SERIES



① **Lounge chair** Grey mottled upholstered fabric. Fabric is removable and washable. Bamboo frame. With practical carrying bag. Load capacity up to 120 kg. Width 75 cm, total height 100 cm, seat height 43 cm, backrest height 70 cm, packing size 119 x 19 x 18 cm. Weight approx. 5.7 kg

920316 100,-

② **Footrest/stool**
Can be used as a practical leg rest or stool to match the lounge chair. Easy to fold. Bamboo frame with grey mottled fabric. Max. load up to 100 kg Dimensions WxHxD: 39 x 34 x 30 cm, Pack size: 51,5 x 30 x 7 cm. Weight approx. 1,5 kg

920317 34,99

NEW: Matching table top/tray for stool
Simply convert the Holiday Travel stool into a side table

③ **MDF table top**, dimensions: 43 x 32,5 x 3,5 cm, weight: 0.8 kg

9203171 12,-

④ **Bamboo table top** can also be used as a tray Dimensions: 43 x 32,5 x 3,5 cm, weight: 1.5 kg

9203172 34,99

Inflatable lounge furniture

Ideal for terrace, balcony and at the campsite. With wide armrests. Removable and washable cover. Soft, comfortable surface. Cover made of high quality 600D polyester with UV 30+ protection coating, water column 850 mm. Colour mottled grey.

⑥ **Sofa for 2 persons with integrated 230 V pump**

Base made of tarpaulin, seat height 40 cm, dimensions: W 167 x H 73 x D 85 cm, pack size: 43 x 20 x 43 cm, weight: 9 kg, load capacity 200 kg

920431 199,-

⑤ **Armchair**

Base made of PE tarpaulin, seat height 40 cm, dimensions: W 100 x H 65 x D 87 cm, pack size: 35 x 16 x 43 cm. Weight: 6 kg, load capacity 110 kg.

920421 139,-

⑦ **Noble inflatable seat cushion**

Removable and washable cover. Soft, pleasant surface. Material cover: 100% polyester, dimensions: Ø 53 x H 23 cm. Maximum load 100 kg. Weight: approx. 0,6 kg. Colour mottled grey

920425 19,99

FITTING:



NEW
2022

For armchairs and seat cushions:
Electric pump 12 V/16 PSI
Incl. valve adapter 930681 59,99



8 PARTY

Delivery without decora-

2-person set

Melamine tableware set retro motif VW T1 & T2
 8-piece melamine dinnerware set consisting of: Plate large (Ø 25,5 cm), plate small (Ø 21,0 cm), soup plate (Ø 23 cm) and mug (H 9,0 cm/250 ml). Dishwasher safe. Weight: ca. 670 g

955220 39,95



2 pcs SET

4 pcs SET

Espresso cups
 With classic Bulli front motif and beautiful colour combinations. A special touch of colour: the bright saucers with Volkswagen lettering. Stylish shape and pleasant cup size Dimensions: (cup & saucer): Ø11 cm, H 6.5 cm

① set of 2 95714 19,99 ② set of 4 95708 34,95



The VW T1 Bus as a camping tent - for 4 people
 As with the original, two doors open with a zipper and lead to two sleeping areas for 2 people each. The sleeping berths are separated by mosquito net doors. Water column: roof 3000 mm / sides 1000 mm. Dimensions: L 398 x H 187 x D 157 cm. Colour blue

957243 449,95



Bulli air freshener in 5 scents
 Made of high-quality special cardboard with paper laminated on both sides. Special extra: The scent is only dosed via the surrounding cardboard edge and thus ensures a discreet and long-lasting scent release. Dimensions: 7x9cm

① Vanilla 95702 2,99
 ② Ocean 957021 2,99
 ③ Citrus 957023 2,99



Multifunctional scarf
 Material: 100% Polyester

Color red 955652 19,94
 Color black/multicolored 955654 19,94



3-piece barbecue cutlery
 handles. Consisting of: Barbecue fork, meat turner and barbecue tongs. Length ca. 43 cm each. Supplied in a case with carrying handle.

95513 44,95



Keyring with bottle opener
 With the Bulli T1 front motif. Dimensions: 4,5 x 8,5 x 0,4 cm

Red 95716 13,60
 Blue 95717 13,60



Ice cube maker
 Blue silicone mould, refrigerator and freezer safe. Ovenproof up to 250°C. Dishwasher safe. Dimensions: L215 x H105 x D35 mm

95728 12,95

Cooler bag in VW T1 bus design
 Fully insulated cooler bag made of 600D polyester (PU coated) with adjustable carrying strap

957291 24,95



Key fob
 In the design of the Bulli T1 front. Chrome plated with enamel. Delivery with gift box per pendant

Red 955390 16,95
 Blue 955391 16,95

Many more VW cult articles can be found on the Internet: www.reimo.com



EDITION: 8/2021 922995

